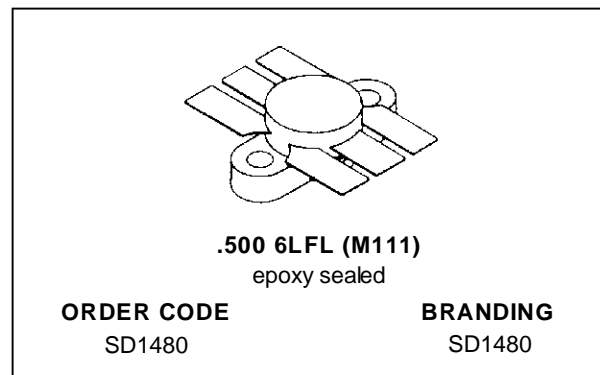
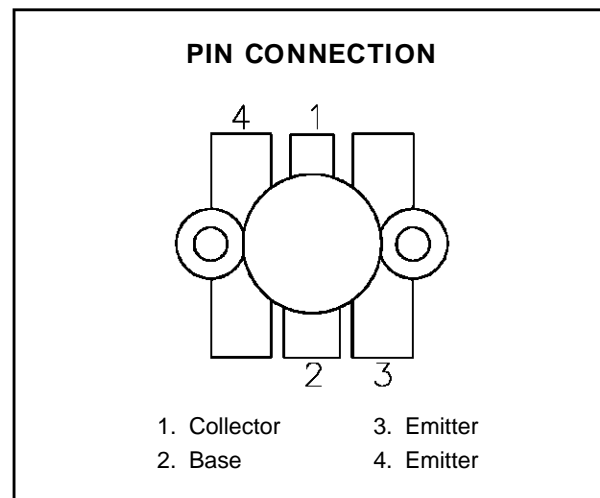

**RF & MICROWAVE TRANSISTORS  
VHF APPLICATIONS**

- 136 - 175 MHz
- 28 VOLTS
- EFFICIENCY 55%
- COMMON EMITTER
- GOLD METALLIZATION
- INTERNAL INPUT MATCHING
- P<sub>OUT</sub> = 125 W MIN. WITH 9.2 dB GAIN

**DESCRIPTION**

The SD1480 is a common emitter 28 V Class C epitaxial silicon NPN planar transistor designed primarily for VHF communications applications. This internally matched device incorporates diffused emitter ballasting resistors and provides high gain and stable operation across the entire 136 - 175 MHz VHF communications band.

**ABSOLUTE MAXIMUM RATINGS** (T<sub>case</sub> = 25°C)

Symbol	Parameter	Value	Unit
V <sub>CB0</sub>	Collector-Base Voltage	65	V
V <sub>CEO</sub>	Collector-Emitter Voltage	36	V
V <sub>CES</sub>	Collector-Emitter Voltage	65	V
V <sub>EBO</sub>	Emitter-Base Voltage	4.0	V
I <sub>c</sub>	Device Current	20	A
P <sub>DISS</sub>	Power Dissipation	270	W
T <sub>J</sub>	Junction Temperature	+200	°C
T <sub>STG</sub>	Storage Temperature	- 65 to +150	°C

**THERMAL DATA**

R <sub>TH(j-c)</sub>	Junction-Case Thermal Resistance	0.65	°C/W
----------------------	----------------------------------	------	------

# SD1480

## ELECTRICAL SPECIFICATIONS (T<sub>case</sub> = 25°C)

### STATIC

Symbol	Test Conditions		Value			Unit
			Min.	Typ.	Max.	
BV <sub>CBO</sub>	I <sub>C</sub> = 100 mA	I <sub>E</sub> = 0 mA	65	—	—	V
BV <sub>CES</sub>	I <sub>C</sub> = 100 mA	V <sub>BE</sub> = 0 V	65	—	—	V
BV <sub>CEO</sub>	I <sub>C</sub> = 100 mA	I <sub>B</sub> = 0 mA	35	—	—	V
BV <sub>EBO</sub>	I <sub>E</sub> = 10 mA	I <sub>C</sub> = 0 mA	4.0	—	—	V
I <sub>CES</sub>	V <sub>CE</sub> = 30 V	I <sub>E</sub> = 0 mA	—	—	15	mA
h <sub>FE</sub>	V <sub>CE</sub> = 5 V	I <sub>C</sub> = 5 A	20	—	200	—

### DYNAMIC

Symbol	Test Conditions			Value			Unit
				Min.	Typ.	Max.	
P <sub>OUT</sub>	f = 150 MHz	P <sub>IN</sub> = 15 W	V <sub>CE</sub> = 28 V	125	—	—	W
P <sub>G</sub>	f = 150 MHz	P <sub>OUT</sub> = 125 W	V <sub>CE</sub> = 28 V	9.2	—	—	dB
η <sub>c</sub>	f = 150 MHz	P <sub>OUT</sub> = 125 W	V <sub>CE</sub> = 28 V	55	—	—	%
C <sub>OB</sub>	f = 1 MHz	V <sub>CB</sub> = 28 V		—	—	250	pF
Load Mismatch	f = 150 MHz	P <sub>IN</sub> = 15 W	V <sub>CE</sub> = 28 V	20:1	—	—	VSWR

### TYPICAL PERFORMANCE

OUTPUT CAPACITANCE vs COLLECTOR BASE VOLTAGE

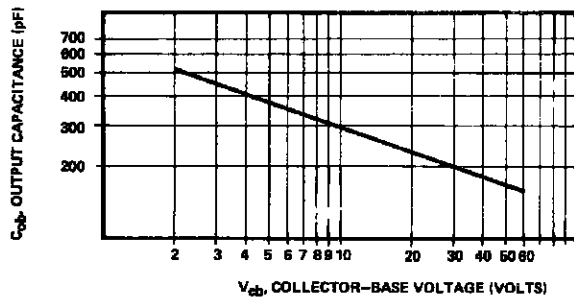

INPUT CAPACITANCE vs EMITTER BASE VOLTAGE

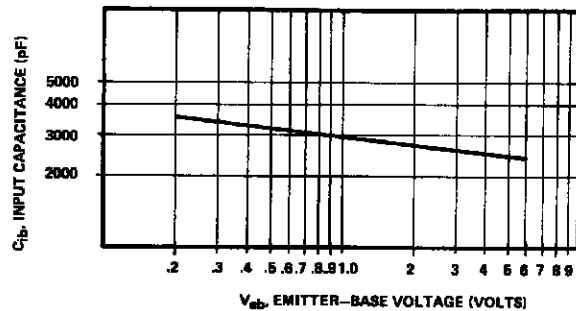

## TYPICAL PERFORMANCE (cont'd)

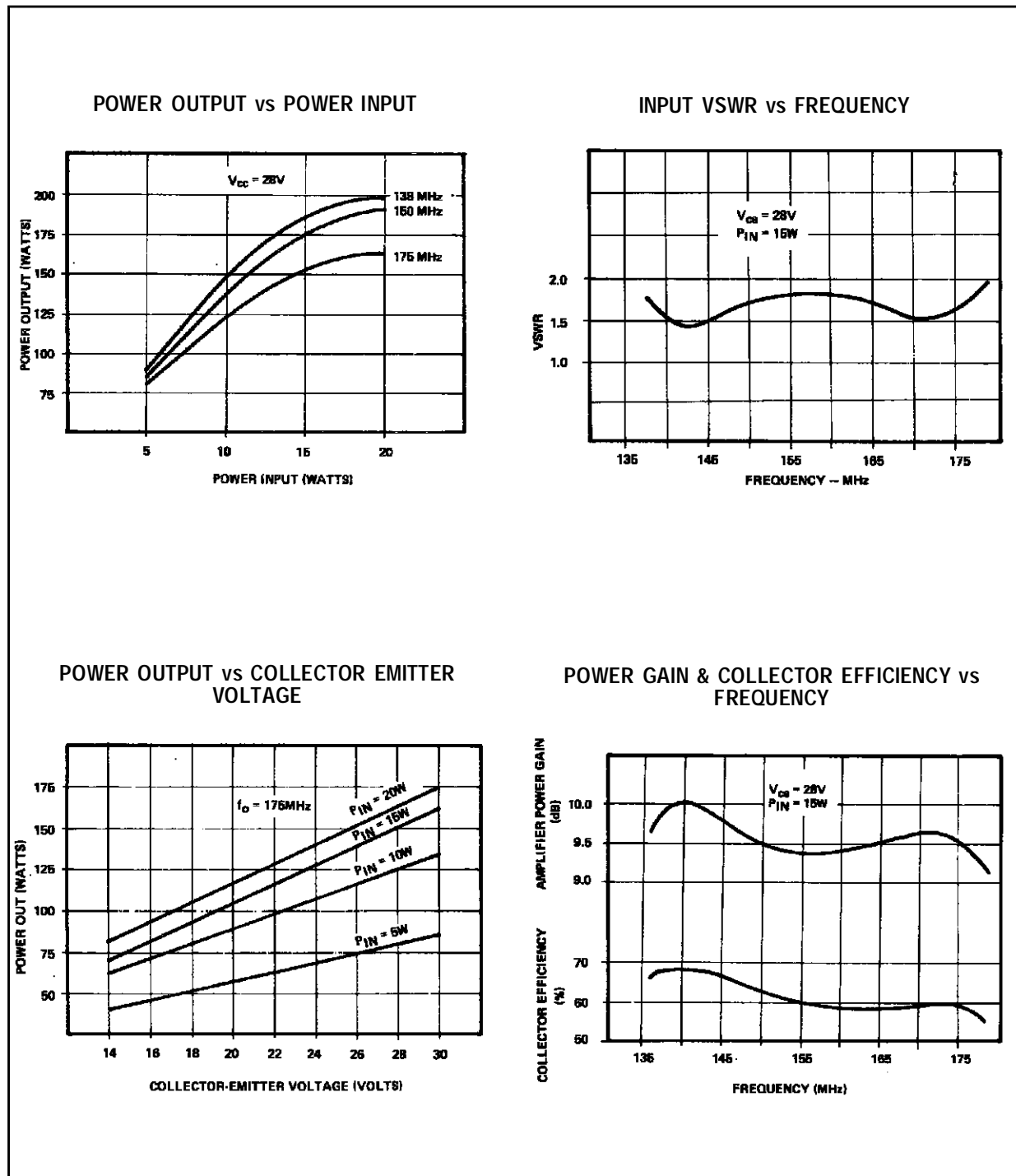

IMPEDANCE DATA

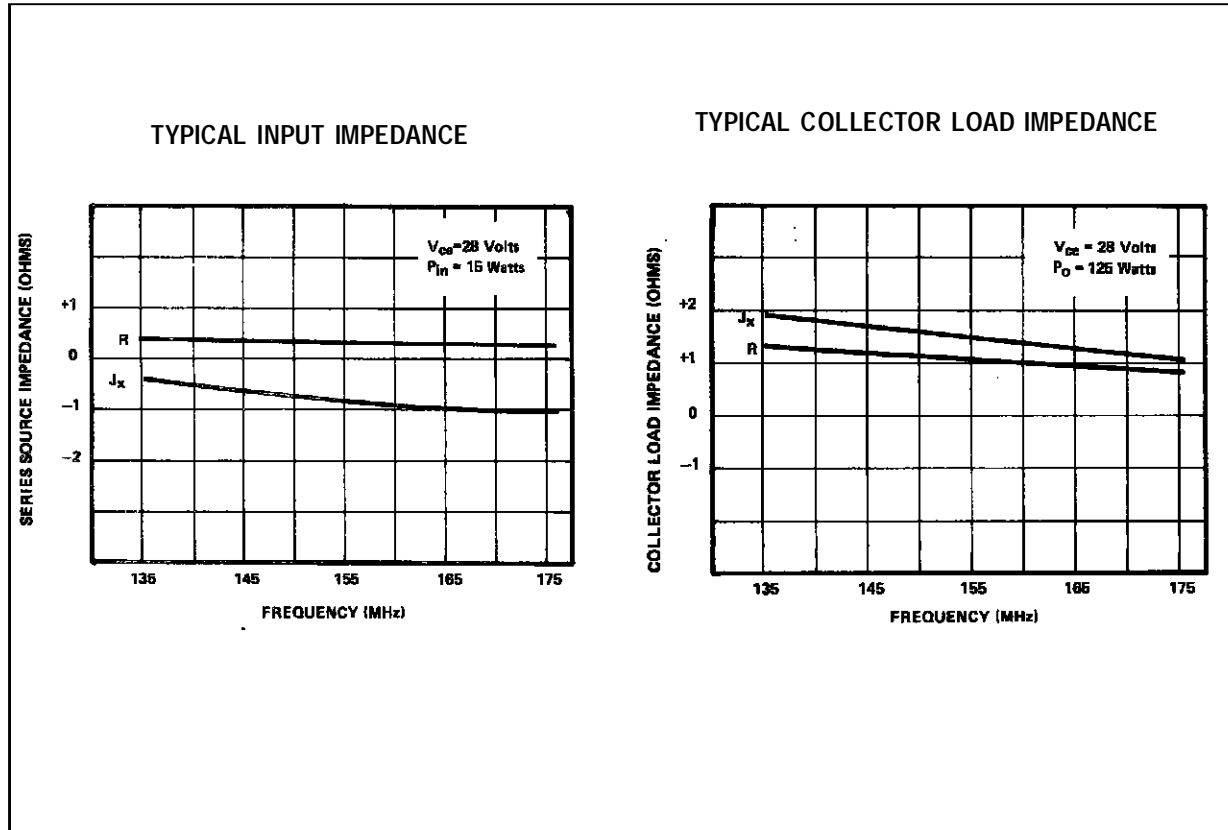

## TEST CIRCUIT

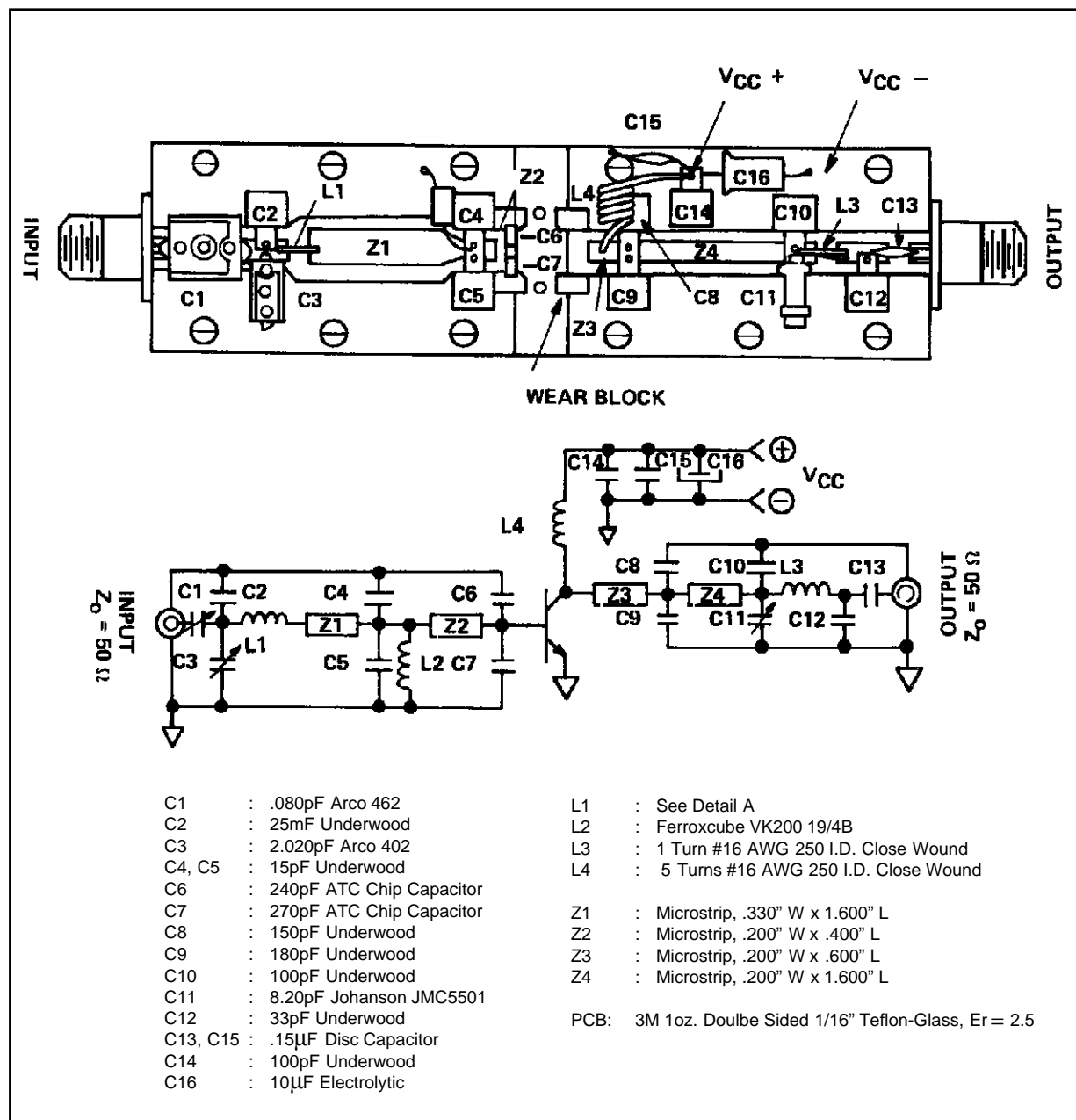

PACKAGE MECHANICAL DATA

Ref.: Dwg. No.12-0111 rev. D

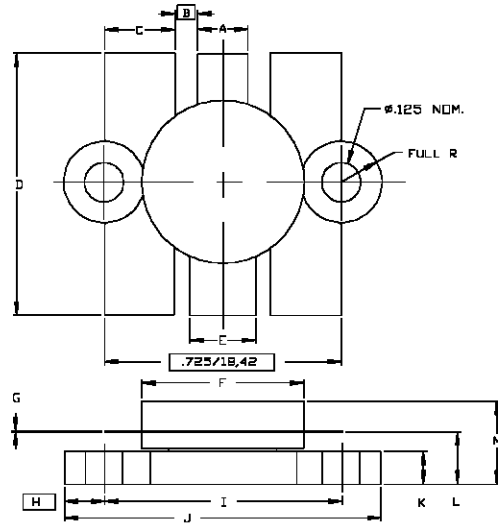

SGS-THOMSON MICROELECTRONICS			CONT'D		
	MINIMUM Inches/mm	MAXIMUM Inches/mm		MINIMUM Inches/mm	MAXIMUM Inches/mm
A	.150/3.43	.160/4.06	K	.095/2.41	.105/2.67
B	.045/1.14		L	.160/4.06	.180/4.58
C	.210/5.33	.220/5.59	H	.285/7.24	
D	.835/21.21	.865/21.97			
E	.200/5.08	.210/5.33			
F	.490/12.45	.510/12.95			
G	.003/0.08	.007/0.19			
H	.125/3.18				
I	.720/18.29	.730/18.54			
J	.970/24.64	.980/24.89			

Information furnished is believed to be accurate and reliable. However, SGS-THOMSON Microelectronics assumes no responsibility for the consequences of use of such information nor for any infringement of patents or other rights of third parties which may result from its use. No license is granted by implication or otherwise under any patent or patent rights of SGS-THOMSON Microelectronics. Specifications mentioned in this publication are subject to change without notice. This publication supersedes and replaces all information previously supplied. SGS-THOMSON Microelectronics products are not authorized for use as critical components in life support devices or systems without express written approval of SGS-THOMSON Microelectronics.

©1994 SGS-THOMSON Microelectronics - All Rights Reserved

SGS-THOMSON Microelectronics GROUP OF COMPANIES  
 Australia - Brazil - France - Germany - Hong Kong - Italy - Japan - Korea - Malaysia - Malta - Morocco - The Netherlands -  
 Singapore - Spain - Sweden - Switzerland - Taiwan - Thailand - United Kingdom - U.S.A.

This datasheet has been download from:

[www.datasheetcatalog.com](http://www.datasheetcatalog.com)

Datasheets for electronics components.