



# PJ1600LIGHT & PJ2000LIGHT

USER MANUAL  
VOLUME1



**File Name:** PJ1600\_2000light\_ING\_1.2.indb

**Version:** 1.2

**Date:** 22/02/2016

### Revision History

Date	Version	Reason	Editor
03/08/2012	1.0	First Version	J. H. Berti
10/05/2013	1.1	Quick Start Addition	J. H. Berti
22/02/2016	1.2	Menu Updates	J. H. Berti

PJ1600LIGHT PJ2000LIGHT - User Manual  
Version 1.2

© Copyright 2012-2016  
R.V.R. Elettronica SpA  
Via del Fonditore 2/2c - 40138 - Bologna (Italia)  
Telephone: +39 051 6010506  
Fax: +39 051 6011104  
Email: [info@rvr.it](mailto:info@rvr.it)  
Web: [www.rvr.it](http://www.rvr.it)

All rights reserved  
Printed and bound in Italy. No part of this manual may be reproduced, memorized or transmitted in any form or by any means, electronic or mechanic, including photocopying, recording or by any information storage and retrieval system, without written permission of the copyright owner.

#### Declaration of Conformity

Hereby, R.V.R. Elettronica SpA, declares that this FM transmitter is in compliance with the essential requirements and other relevant provisions of Directive 1999/5/EC.



## WARNING



The following information is needed in order to perform the change of output power.  
 The non-respect of this content may cause damage to the equipment or to the people.  
 Menus and images are for illustration purposes only and may differ from reality.



### 1. Startup procedure TX with PJ1600LIGHT GREEN LINE amplifiers

1	Turn ON the exciter using the front switch	
2	Set the output power of the exciter to zero.	
3	Set the exciter frequency to the working value	
4	Turn on the amplifier using the front switch	
5	Set the amplifier on LOCAL: press "ESC" key then select "Fnc" menu then change to LOCAL if necessary.	
6	Press "ESC" key until the display shows the main screen (FWD and RFL readings)	
7	On amplifier, press "Enter" key and keep it pressed until the first row in the display shows "Set:                    "	
8	Adjust the bar to mid scale using the arrow keys and press the "Enter" key.	
9	Put the output power of the exciter verifying that PA has at least <b>20W</b> . To check it press "ESC" key then select "Pwr" menu then press down arrow to visualize the measure.	
10	Press "ESC" key until the display shows the main screen (FWD and RFL readings)	
11	Following the procedure on point (7), slowly raise the power output of amplifier until reaching the desired value.	
12	After ten minutes, readjust the output power of the amplifier, it will be lowered due to heating.	
13	Set the amplifier on REMOTE: press "ESC" key then select "Fnc" menu then change to REMOTE if necessary.	
14	Repeat the procedure if the carrier frequency is changed.	

# WARNING



The following information is needed in order to perform the change of output power.  
 The non-respect of this content may cause damage to the equipment or to the people.  
 Menus and images are for illustration purposes only and may differ from reality.



## 1. Startup procedure TX with PJ2000LIGHT GREEN LINE amplifiers

1	Turn ON the exciter using the front switch	
2	Set the output power of the exciter to zero.	
3	Set the exciter frequency to the working value	
4	Turn on the amplifier using the front switch	
5	Put the output power of the exciter verifying that PA has at least <b>20W</b> . To check it press "ESC" key then select "Pwr" menu then press down arrow to visualize the measure.	
6	Press "ESC" key until the display shows the main screen (FWD and RFL readings)	
7	After ten minutes, readjust the output power of the amplifier, it will be lowered due to heating.	
8	Repeat the procedure if the carrier frequency is changed.	



# DECLARATION OF CONFORMITY

**We, the undersigned,**

Manufacturer's Name: **R.V.R. Elettronica SpA**

Manufacturer's Address: **Via del Fonditore 2/2c  
Zona Ind. Roveri  
40138 Bologna  
Italy**

**Certify and declare under our sole responsibility that the product:**

Product Description: **FM Solid State Amplifier for Broadcast service**

Models: **PJ2000LIGHT**

Variants: **PJ1600LIGHT**

Frequency Range: **87.5 ÷ 108.0 MHz**

RF Power Output: **160 ÷ 2000 W**

**when used for its intended purpose, is in compliance with the essential requirements and other relevant provisions of Directive 1999/5/CE "R&TTE", and therefore carries the "CE" mark.**

The conformity assessment procedure referred in Article 10 and detailed in Annex III of Directive 1999/5/EC has been followed.

The following harmonized standard have been applied:

**ElectroMagnetic Compatibility (3.1b):** EN 301 489-1 V1.9.2 (2011-09) +  
EN 301 489-11 V1.3.1 (2006-05)

**Safety (3.1a):** EN 60215 (1997-10) +  
EN 60065 (2011-01)

The technical documentation is held at the location above, as required by the conformity assessment procedure.

Bologna, Italy, 26/05/2011

  
Ravagnani Stefano  
Technical Manager  
R.V.R. Elettronica S.p.A.



# Technical Specification

			PJ1600Light	PJ2000Light	
Parameters	Conditions	U.M.			
<b>GENERALS</b>					
Frequency range		MHz	87.5 ± 108	87.5 ± 108	
Rated output power		W	1600	2000	
Power supply type			Mono phase	Mono phase	
AC Supply Voltage	Mains input voltage range	VAC	230 ±15%	230 ±15%	
DC Supply Voltage	CPU backup Input Voltage	VDC			
Active Power Consumption		W	2285	2857	
Overall efficiency		%	Typical 70	Typical 70	
Input device			4 pushbutton	4 pushbutton	
Display			Alphanumerical LCD - 2 x 16	Alphanumerical LCD - 2 x 16	
Physical Dimensions	Front panel width	mm	483	483	
	Front panel height	HE	3	3	
	Overall depth	mm	550	550	
Ambient working temperature		°C	0 to + 50 (operational -10)	0 to + 50 (operational -10)	
Spurious & harmonic suppression		dBc	<75 (80 typical)	<75 (80 typical)	Meets or exceeds all FCC and CCIR rules
<b>RF INPUT</b>					
RF Input	Connector		N type	N type	
	Impedance	Ohm	50	50	
Driver power for rated output		W	20	25	
Max input power before protection		W	30	30	
<b>RF OUTPUTS</b>					
RF Output	Connector		7/16"	7/16"	
	Impedance	Ohm	50	50	
RF Monitor	Connector		BNC	BNC	
	Impedance	Ohm	50	50	
	Output Level	dBc	approx. -60	approx. -60	Referred to the RF output
<b>AUXILIARY CONNECTIONS</b>					
Interlock	Connector		2 x BNC	2 x BNC	For remote power inhibition (short is RF off)
Service	Connector		DB9 F	DB9 F	Factory reserved for firmware program
I <sup>2</sup> Cbus	Connector		DB9 F	DB9 F	
Telemetry Interface	Connector		DB25F	DB25F	
<b>POWER REQUIREMENTS</b>					
AC Power Input	AC Supply Voltage	VAC	230 ±15%	230 ±15%	
	AC Apparent Power Consumption	VA	2289	2862	
	Active Power Consumption	W	2285	2857	
	Power Factor		0,998	0,998	
DC Power Input	Connector		Terminal Block	Terminal Block	
	DC Supply Voltage	VDC			
	DC Current	ADC			
<b>FUSES</b>					
On Mains			2 External F 25 T - 10 x 38	2 External F 25 T - 10 x 38	
On services			1 Internal F 3,15 A 2 x 20 mm	1 Internal F 3,15 A 2 x 20 mm	
On PA Supply			2 Internal F 25 A 10 x 38 mm	3 Internal F 25 A 10 x 38 mm	
On Aux VDE socket					
<b>MECHANICAL DIMENSIONS</b>					
Physical Dimensions	Front panel width	mm	483 (19")	483 (19")	19" EIA rack
	Front panel height	mm	132 (5,20")	132 (5,20")	
	Overall depth	mm	550 (21,65")	550 (21,65")	
	Chassis depth	mm	500 (19,69")	500 (19,69")	
Weight		kg	about 25	about 25	
<b>OPTIONS</b>					
		code	/CNT7/8-150	/CNT7/8-150	
<b>TELEMETRY / TELECONTROL</b>					
Remote connector inputs	Pulse		Command ON	Command ON	For P.A. A.G.C. purpose, min 0,5 Vcc
	Pulse		Command OFF	Command OFF	
	Pulse		Alarm Reset	Alarm Reset	
Remote connector outputs	Analogical level		FWD power	FWD power	
	Analogical level		REF power	REF power	
	Analogical level				
	Analogical level				
	Analogical level		VPA	VPA	
	Analogical level		IPA	IPA	
	Analogical level				
	Open Collector		Status ON	Status ON	
	Open Collector		Status OFF	Status OFF	
	Open Collector		Power Good 1	Power Good 1	
	Open Collector		Power Good 2	Power Good 2	
	Open Collector				For P.A. A.G.C. purpose, min 0,5 Vcc
	Open Collector		Wait	Wait	
Open Collector		Fault	Fault		
Open Collector		Local	Local	for remote power inhibition (short is RF off)	
Remote connector others			Interlock	Interlock	
			I2Cbus	I2Cbus	
<b>VARIOUS</b>					
Cooling type			Forced, with internal fan	Forced, with internal fan	
Acoustic Noise		dBa	<75	<75	Leq 3 min @ 1 m

# Table of Contents

<b>1.</b>	<b>Preliminary Instructions</b>	<b>1</b>
<b>2.</b>	<b>Warranty</b>	<b>1</b>
<b>3.</b>	<b>First Aid</b>	<b>2</b>
3.1	Treatment of electrical shocks	2
3.2	Treatment of electrical Burns	2
<b>4.</b>	<b>General Description</b>	<b>3</b>
4.1	Unpacking	3
4.2	Features	3
4.3	Frontal Panel Description	5
4.4	Rear Panel Description	6
4.5	Connectors Description	7
<b>5.</b>	<b>Quick guide for installation and use</b>	<b>9</b>
5.1	Preparation	9
5.2	First power-on and setup	11
5.3	Operation	13
5.4	Management Firmware	15
<b>6.</b>	<b>Identification and Access to the Modules</b>	<b>22</b>
6.1	Upper view PJ1600LIGHT	22
6.2	Upper view PJ2000LIGHT	23
6.3	Bottom View PJ1600/2000LIGHT	24
<b>7.</b>	<b>Working Principles</b>	<b>25</b>
7.1	PJ1600/2000LIGHT Common Parts	28

*This page was intentionally left blank*



## IMPORTANT



The symbol of lightning inside a triangle placed on the product, evidences the operations for which is necessary gave it full attention to avoid risk of electric shocks.



The symbol of exclamation mark inside a triangle placed on the product, informs the user about the presence of instructions inside the manual that accompanies the equipment, important for the efficacy and the maintenance (repairs).

## 1. Preliminary Instructions

### • General Warnings

This equipment should only be operated, installed and maintained by "trained" or "qualified" personnel who are familiar with risks involved in working on electric and electronic circuits. "Trained" means personnel who have technical knowledge of equipment operation and who are responsible for their own safety and that of other unqualified personnel placed under their supervision when working on the equipment. "Qualified" means personnel who are trained in and experienced with equipment operation and who are responsible for their own safety and that of other unqualified personnel placed under their supervision when working on the equipment.

**⚡ WARNING: Residual voltage may be present inside the equipment even when the ON/OFF switch is set to Off. Before servicing the equipment, disconnect the power cord or switch off the main power panel and make sure the safety earth connection is connected. Some service situations may require inspecting the equipment with live circuits. Only trained and qualified personnel may work on the equipment live and shall be assisted by a trained person who shall keep ready to disconnect power supply at need.**

R.V.R. Elettronica S.p.A. shall not be liable for injury to persons or damage to property resulting from improper use or operation by trained/untrained and qualified/unqualified persons.

**⚡ WARNING: The equipment is not water resistant. Any water entering the enclosure might impair proper operation. To prevent the risk of electrical shock or fire, do not expose this equipment to rain, dripping or moisture.**

Please observe local codes and fire prevention rules when installing and operating this equipment.

**⚡ WARNING: This equipment contains exposed live parts involving an electrical shock hazard. Always disconnect power supply before removing any covers or other parts of the equipment.**

Ventilation slits and holes are provided to ensure reliable operation and prevent overheating; do not obstruct or cover these slits. Do not obstruct the ventilation slits under any circumstances. The product must not be incorporated in a rack unless adequate ventilation is provided or the manufacturer's instructions are followed closely.

**⚠ WARNING: This equipment can radiate radiofrequency energy and, if not installed in compliance with manual instructions and applicable regulations, may cause interference with radio communications.**

**⚠ WARNING: This equipment is fitted with earth connections both in the power cord and for the chassis. Make sure both are properly connected.**

Operation of this equipment in a residential area may cause radio interference, in which case the user may be required to take adequate measures.

The specifications and data contained herein are provided for information only and are subject to changes without prior notice. R.V.R. Elettronica S.p.A. disclaims all warranties, express or implied. While R.V.R. Elettronica S.p.A. attempts to provide accurate information, it cannot accept responsibility or liability for any errors or inaccuracies in this manual, including the products and the software described herein. R.V.R. Elettronica S.p.A. reserves the right to make changes to equipment design and/or specifications and to this manual at any time without prior notice.

### • Notice concerning product intended purpose and use limitations.

This product is a radio transmitter suitable for frequency-modulation audio radio broadcasting. Its operating frequencies are not harmonised in designated user countries. Before operating this equipment, user must obtain a licence to use radio spectrum from the competent authority in the designated user country. Operating frequency, transmitter power and other characteristics of the transmission system are subject to restrictions as specified in the licence.

## 2. Warranty

La R.V.R. Elettronica S.p.A. warrants this product to be free from defects in workmanship and its proper operation subject to the limitations set forth in the supplied Terms and Conditions. Please read the Terms and Conditions carefully, as purchase of the product or acceptance of the order acknowledgement imply acceptance of the Terms and Conditions. For the latest updated terms and conditions, please visit our web site at WWW.RVR.IT. The web site may be modified, removed or updated for any reason whatsoever without prior notice. The warranty will become null and void in the event the product enclosure is opened, the product is physically damaged, is repaired by unauthorised persons or is used for purposes other than its intended use, as well as in the event of improper use, unauthorised changes or neglect. In the event a defect is found, follow this procedure:

- 1 Contact the seller or distributor who sold the equipment; provide a description of the problem or malfunction for the event a quick fix is available.

Sellers and Distributors can provide the necessary information to troubleshoot the most frequently encountered problems. Normally, Sellers and Distributors can offer a faster repair service than the Manufacturer would. Please note that Sellers can pinpoint problems due to wrong installation.

- 2 If your Seller cannot help you, contact R.V.R. Elettronica S.p.A. and describe the problem; if our staff deems it appropriate, you will receive an authorisation to return the equipment along with suitable instructions;
- 3 When you have received the authorisation, you may return the unit. Pack the unit carefully before shipment; use the original packaging whenever possible and seal the package perfectly. The customer bears all risks of loss (i.e., R.V.R. shall not be liable for loss or damage) until the package reaches the R.V.R. factory. For this reason, we recommend insuring the goods for their full value. Returns must be sent on a C.I.F. basis (PREPAID) to the address stated on the authorisation as specified by the R.V.R. Service Manager.



Units returned without a return authorisation may be rejected and sent back to the sender.

- 4 Be sure to include a detailed report mentioning all problems you have found and copy of your original invoice (to show when the warranty period began) with the shipment.

Please send spare and warranty replacement parts orders to the address provided below. Make sure to specify equipment model and serial number, as well as part description and quantity.



R.V.R. Elettronica S.p.A.  
Via del Fonditore, 2/2c  
40138 BOLOGNA ITALY  
Tel. +39 051 6010506

## 3. First Aid

All personnel engaged in equipment installation, operation and maintenance must be familiar with first aid procedures and routines.

### 3.1 Electric shock treatment

#### 3.1.1 If the victim is unconscious

Follow the first aid procedures outlined below.

- Lay the victim down on his/her back on a firm surface.
- the neck and tilt the head backwards to free the airway system (**Figure 1**).

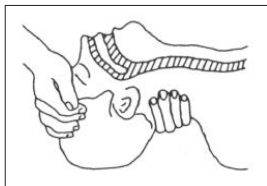

Figure 1

- If needed, open the victim's mouth and check for breathing.
- If there is no breathing, start artificial respiration without delay (**Figure 2**) as follows: tilt the head backwards, pinch the nostrils, seal your mouth around the victim's mouth and give four fast rescue breaths.



Figure 2

- Check for heartbeat (**Figure 3**); if there is no heartbeat, begin chest compressions immediately (**Figure 4**) placing your hands in the centre of the victim's chest (**Figure 5**).

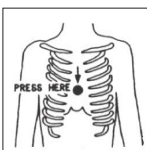
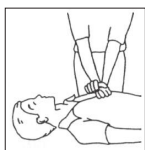
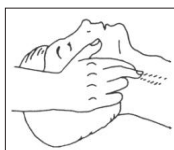

Figure 3

Figure 4

Figure 5

- One rescuer: give 2 quick rescue breaths after each 15 compressions.
- Two rescuers: one rescue breath after each 5 compressions.

- Do not stop chest compressions while giving artificial breathing.
- Call for medical help as soon as possible.

#### 3.1.2 If the victim is conscious

- Cover victim with a blanket.
- Try to reassure the victim.
- Loosen the victim's clothing and have him/her lie down.
- Call for medical help as soon as possible.

### 3.2 Treatment of electric burns

#### 3.2.1 Large burns and broken skin

- Cover affected area with a clean cloth or linen.
- Do not break any blisters that have formed; remove any clothing or fabric that is stuck to the skin; apply adequate ointment.
- Administer adequate treatment for the type of accident.
- Get the victim to a hospital as quickly as possible.
- Elevate arms and legs if injured.

If medical help is not available within an hour, the victim is conscious and is not retching, administer a solution of table salt and baking soda (one teaspoon of table salt to half teaspoon of baking soda every 250 ml of water).

Have the victim slowly drink half a glass of solution for four times during a period of 15 minutes.

Stop at the first sign of retching.

Do not administer alcoholic beverages.

#### 3.2.2 Minor burns

- Apply cold (not ice cold) strips of gauze or dress wound with clean cloth.
- Do not break any blisters that have formed; remove any clothing or fabric that is stuck to the skin; apply adequate ointment.
- If needed, have the victim change into clean, dry clothing.
- Administer adequate treatment for the type of accident.
- Get the victim to a hospital as quickly as possible.
- Elevate arms and legs if injured.

## 4. General Description

The **PJ1600/2000LIGHT** is an **radio broadcasting amplifier** manufactured by **R.V.R. Elettronica SpA** featuring adjustable RF power output up to 1600/2000 W under 50 Ohm standard load and less than 12/18 W drive power requirement.

The **PJ1600LIGHT** and **PJ2000LIGHT** are designed to being contained into a 19" rack box of 3HE.

### 4.1 Unpacking

The package contains:

- 1 **PJ1600LIGHT** or **PJ2000LIGHT**
- 1 User Manual
- 1 Mains power cables

The following accessories are also available from Your R.V.R. Dealer:

- **Accessories, spare parts and cables**

### 4.2 Features

The overall efficiency of **PJ1600LIGHT** and **PJ2000LIGHT** is better than 70% across the bandwidth, for this reason are part of RVR Green Line family.

This performance characteristic is guaranteed in a range between +0.25 dB and -3 dB (+5% and -50%) referred to the nominal power of the equipment: for example from 800W to 1680W in case of **PJ1600LIGHT** or from 1000W to 2100W in case of **PJ2000LIGHT**; outside these limits the equipment is able to work properly but can not guarantee an efficiency of 70%.

The operating logic during the output power regulation, which is necessary in order to not deteriorate the efficiency even of 5-6%, expects to set the pilot power to the optimum power (dependent on the amplifier: for example the **PJ1600LIGHT** requires 20/21 W, while the **PJ2000LIGHT** requires 24/25 W) and then successively adjust the bar setting of power on amplifier in order to obtain the desired output power.

La logica di funzionamento nella fase di impostazione della potenza di uscita, necessaria al fine di non peggiorare il rendimento anche del 5-6%, prevede di impostare la potenza del pilota alla potenza ottimale (dipendente dall'amplificatore: il **PJ1600LIGHT** ad esempio necessita di 20/21 W, mentre il **PJ2000LIGHT** ad esempio necessita di 24/25 W) e quindi successivamente di settare la barra di impostazione della potenza sull'amplificatore per ottenere la potenza di uscita desiderata.

The amplifier incorporates a low-pass filter to keep harmonics below the limits provided for by international standards (CCIR, FCC or ETSI).



Two major features of **PJ1600/2000LIGHT** are compact design and user-friendliness. Another key feature is its modular-concept design: the different functions are performed by modules with most connections achieved through male and female connectors or through flat cables terminated by connectors. This design facilitates maintenance and module replacement.

The RF power section of **PJ1600LIGHT** uses two LD-MOSFET modules delivering up to 800W output power each, whereas **PJ2000LIGHT** features three LD-MOSFET modules with same output power each.

An LCD on the front panel and a push-button panel provide for user interfacing with the microprocessor control system, which implements the following features:

- Output power setup.
- Power output enable/disable.
- User-selectable threshold settings for output power alarm (Power Good feature)
- Measurement and display of amplifier operating parameters.
- Communication with external devices such as programming or telemetry systems via RS232 serial interface or I<sup>2</sup>C.

Four LEDs on the front panel provide the following status indications: **ON**, **FAULT**, **FOLDBACK** and **RF MUTE**.



The amplifier management firmware is based on a menu system. User has four navigation buttons available to browse submenus: **ESC** ,  ,  ,  , and **ENTER**.

The rear panel features the mains input connectors, RF power input and output connectors, remote connector, protection fuse, interlock input and interlock output connectors and a BNC connector that provides an RF test point with level being -60dBc lower than power output..

## 4.3 Frontal Panel Description

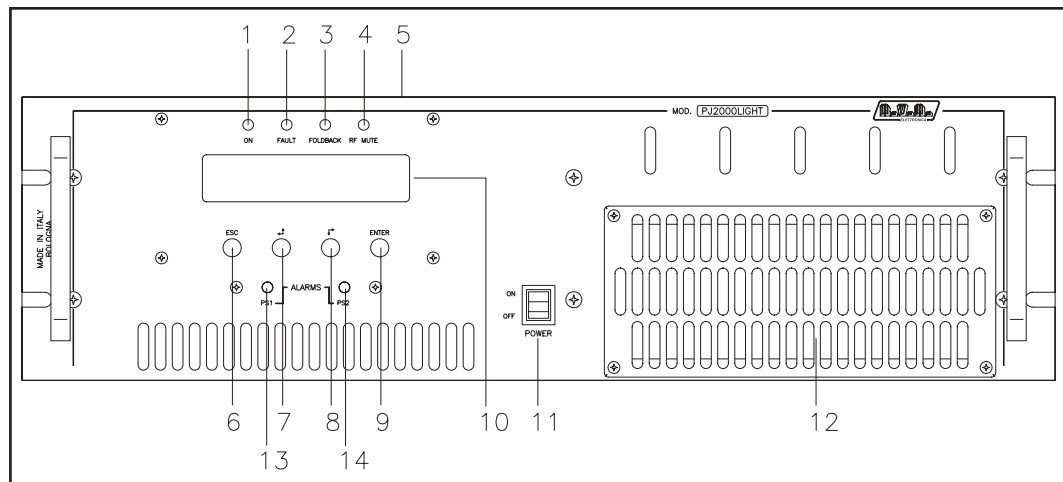
### 4.3.1 Frontal Panel Description of PJ1600/2000LIGHT



- |                                                                                         |                                                                                                                                                                                                                                                                                                 |
|-----------------------------------------------------------------------------------------|-------------------------------------------------------------------------------------------------------------------------------------------------------------------------------------------------------------------------------------------------------------------------------------------------|
| [1] ON                                                                                  | Green LED - Turns on when amplifier is powered on.                                                                                                                                                                                                                                              |
| [2] FAULT                                                                               | Red LED, lit on presence of a fault that can not be resolved automatically.                                                                                                                                                                                                                     |
| [3] FOLDBACK                                                                            | Yellow LED - Turns on when foldback current limiting (Automatic Gain Control) is intervened.                                                                                                                                                                                                    |
| [4] R.F. MUTE                                                                           | Yellow LED, lit on when the amplifier's power output is inhibited by an external interlock command.                                                                                                                                                                                             |
| [5] CONTRAST                                                                            | Display contrast adjusting trimmer (on the top of the equipment).                                                                                                                                                                                                                               |
| [6] ESC                                                                                 | Press this button to exit a menu.                                                                                                                                                                                                                                                               |
| [7]  | Navigation button used to browse menu system and edit parameters.                                                                                                                                                                                                                               |
| [8]  | Navigation button used to browse menu system and edit parameters.                                                                                                                                                                                                                               |
| [9] ENTER                                                                               | Press this button to confirm a modified parameter and open a menu.                                                                                                                                                                                                                              |
| [10] DISPLAY                                                                            | Liquid Crystal Display.                                                                                                                                                                                                                                                                         |
| [11] POWER                                                                              | AC mains ON/OFF switch.                                                                                                                                                                                                                                                                         |
| [12] AIR FLOW                                                                           | Grid for the intake of the air flow of the forced ventilation.                                                                                                                                                                                                                                  |
| [13] ALARMS PS1                                                                         | Yellow LED - Turns on when Power Supply unit is not fed either because "PWR OFF" was selected via software, or power is set to 0 W, or due to Power Supply malfunction (when this LED turns on, it causes the ALARM PS2 LED to come on as well, because the two LEDs are connected internally). |
| [14] ALARMS PS2                                                                         | Yellow LED, see item [13].                                                                                                                                                                                                                                                                      |

## 4.4 Rear Panel Description

### 4.4.1 Rear Panel Description of PJ1600/2000LIGHT

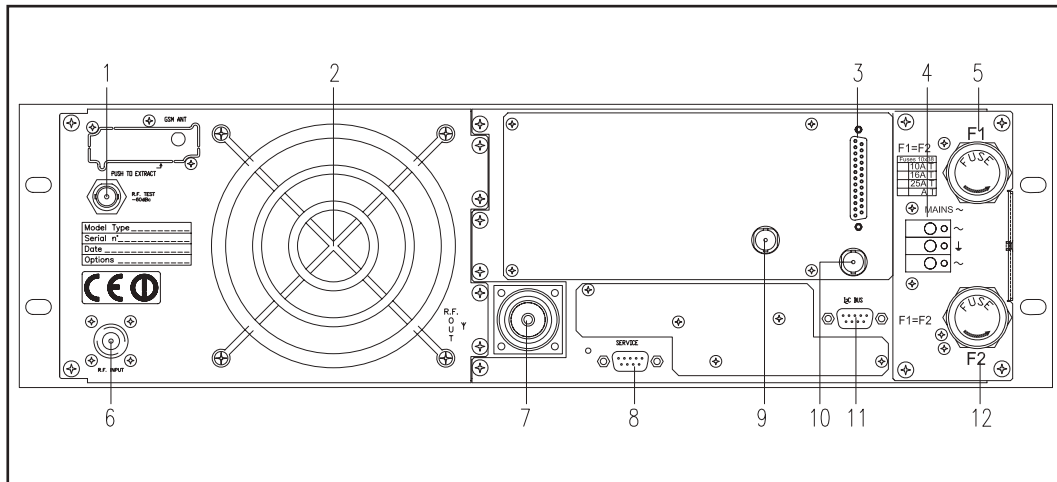

- |                       |                                                                                                                                           |
|-----------------------|-------------------------------------------------------------------------------------------------------------------------------------------|
| [1] R.F. TEST -60dBc  | Output at -60 dB referred to output power level, adapted to modulation monitoring. Do not use it for spectral analysis.                   |
| [2] AIR FLOW          | Grid for the intake of the air flow of the forced ventilation.                                                                            |
| [3] REMOTE            | DB25 connector for telemetry of the machine.                                                                                              |
| [4] MAINS             | Mains supply connectors, 230 V 50-60 Hz.                                                                                                  |
| [5] FUSE1             | Mains supply fuse.                                                                                                                        |
| [6] R.F. INPUT        | RF input connector, N-type.                                                                                                               |
| [7] R.F. OUTPUT       | RF output connector, 7/16" EIA flange.                                                                                                    |
| [8] SERVICE           | DB9 connector for interconnection with other devices and for factory parameters programming (only for factory programming).               |
| [9] INTERLOCK OUT     | Interlock output BNC connector: to inhibit an external device, as an exciter. In case of fault, the inner connector is shorted to ground. |
| [10] INTERLOCK IN     | Interlock input BNC connector: to inhibit the amplifier from an external device, like an exciter.                                         |
| [11] I <sup>2</sup> C | DB9 connector for I <sup>2</sup> C bus networking.                                                                                        |
| [12] FUSE2            | Mains supply fuse.                                                                                                                        |

## 4.5 Connectors Description

### 4.5.1 Remote

Type: Female DB25

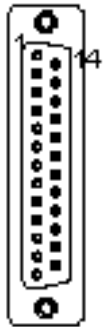

1	NC	
2	RF power amplifier voltage	3,9V x 50V
3	GND	GND
4	Reflected Power	3.9V x 160/175W (depending on model)
5	Interlock Out	Signals the activation by grounding the contact normally open
6	NC	
7	GND	GND
8	“On” Command	A pulse to ground (500 ms) delivers power output
9	Set 1 (FWD Power Good 1)	
10	WAIT	Signals the activation by grounding the contact normally open
11	Reset alarm	
12	OFF	A pulse to ground (500 ms) indicates the inhibit of power output
13	Interlock	Signals the activation by grounding the contact normally open
14	NC	
15	RF power amplifier current	3.9V x 80/94 A (depending on model)
16	Forward Power	3.9V x 1600/2000W (depending on model)
17	FAULT	Signals the activation by grounding the contact normally open
18	Set 3 (RFL Power Good 3)	
19	Input power	3.9V x 20/25W (depending on model)
20	“OFF” Command	A pulse to ground (500 ms) inhibits power output
21	GND	GND
22	Set 2 (FWD Power Good 2)	
23	LOC	Signals the activation by grounding the contact normally open

24 +Vcc  
25 ON

A pulse to ground (500 ms) indicates the deliver of power output

#### 4.5.2 I<sup>2</sup>C Bus

Type: Male DB9

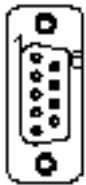

1	NC	
2	SDA	Serial DATA
3	SCL	Serial CLOCK
4	NC	
5	GND	GND
6	NC	
7	NC	
8	NC	
9	NC	

#### 4.5.3 Service (for programming of factory parameters)

Type: Female DB9



1	NC
2	TX_D
3	RX_D
4	Internally connected with 6
5	GND
6	Internally connected with 4
7	Internally connected with 8
8	Internally connected with 7
9	NC



## 5. Quick guide for installation and use

This section provides a step-by-step description of equipment installation and configuration procedure. Follow these procedures closely upon first power-on and each time any change is made to general configuration, such as when a new transmission station is added or the equipment is replaced.

Once the desired configuration has been set up, no more settings are required for normal operation; at each power-up (even after an accidental shutdown), the equipment defaults to the parameters set during the initial configuration procedure.

The topics covered in this section are discussed at greater length in the next sections, with detailed descriptions of all hardware and firmware features and capabilities. Please see the relevant sections for additional details.



**IMPORTANT:** *When configuring and testing the transmitter in which the equipment is integrated, be sure to have the Final Test Table supplied with the equipment ready at hand throughout the whole procedure; the Final Test Table lists all operating parameters as set and tested at the factory.*

### 5.1 Preparation

#### 5.1.1 Preliminary checks

Unpack the amplifier and immediately inspect it for transport damage. Ensure that all connectors are in perfect condition.

The main fuse can be accessed from the outside on the rear panel. Extract the fuse carrier with a screwdriver to check its integrity or for replacement, if necessary.

The following fuses are used:

	@ 230 VAC
Main Fuse (PJ1600LIGHT)	25A type 10x38
Main Fuse (PJ2000LIGHT)	25A type 10x38

Table 5.1: *Fuse*

Provide for the following (applicable to operating tests and putting into service):

- ✓ Single phase mains power supply 230 VAC ( $\pm 15\%$ ) for **PJ1600/2000LIGHT**, with adequate earth connection.
- ✓ For operating tests only: dummy load with 50 Ohm impedance and adequate capacity (1600W for **PJ1600LIGHT** or 2000W for **PJ2000LIGHT** as a minimum).
- ✓ Connection cable kit including:
  - Mains power cable.
  - Coaxial cable with BNC connectors for interlock signal connection between exciter and amplifier.
  - RF cable for output to load / antenna (50 Ohm coaxial cable with standard 7/8" connector).

## 5.1.2 Connections

Connect the output of a suitable FM exciter (for instance, PTX30LCD exciter available from R.V.R. Elettronica) to the RF input using a 50 Ohm coaxial cable with "N"-type connectors. To begin with, set exciter to minimum output power and switch if off.

Connect the amplifier INTERLOCK OUT output to the matching INTERLOCK IN input fitted on all R.V.R. Elettronica exciters as standard; if your exciter is a different brand, identify an equivalent input.

Connect the RF output to an adequately rated dummy load or to the antenna.

**The diagram of RF connection and control between the amplifier and its exciter and connection with the load, is represented in Figure 5.2.**

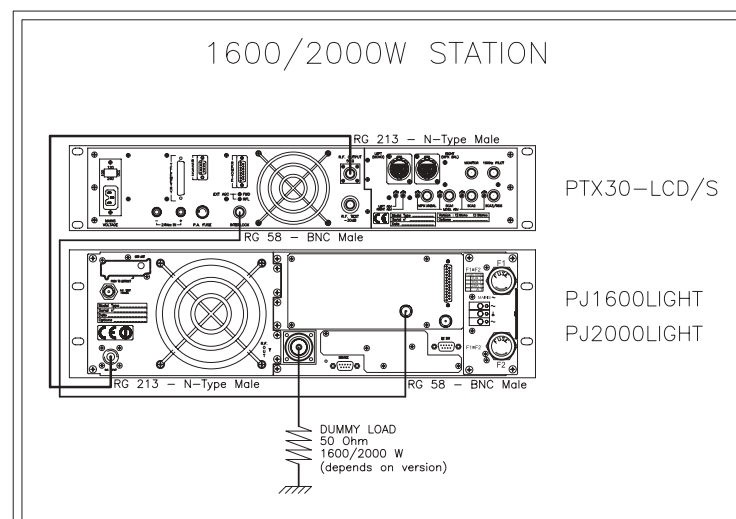

Figure 5.1: connections with amplifier



**WARNING: Electric shock hazard! Never handle the RF output connector when the equipment is powered on and no load is connected. Injury or death may result.**

Ensure that the **POWER** switch on the front panel is set to “**OFF**”.

Connect the mains power cable to the MAINS connector on the rear panel.



**Note** : *The mains must be equipped with adequate ground connection properly connected to the machine. This is a pre-requisite for ensuring operator safety and correct operation.*



**WARNING:** The power supply connector is a terminal board. Ensure the wire is not live before performing the connection.

## 5.2 First power-on and setup

Follow this procedure upon first power-on and after making changes to the configuration of the transmitter in which the amplifier is integrated.



**Note** : *Standard factory settings are RF output power off (**Pwr OFF**) and regulated output power set to upper limit (unless otherwise specified by customer).*

### 5.2.1 Pilot exciter setup

Set up the pilot exciter so that the output power it delivers to a matched load equals the maximum input power indicated in the amplifier **final test table**, switch off the exciter and connect it to the amplifier.



**IMPORTANT:** *to obtain the maximum efficiency, place the excitation power to a 20W as minimum.*

### 5.2.2 Power-on

When you have performed all of the connections described in the previous paragraph, power on the amplifier using the suitable power switch on the front panel. Also, switch on the pilot exciter.

### 5.2.3 Power check

Ensure that the **ON** light turns on. Machine name should appear briefly on the display, quickly followed by forward and reflected power readings (figure 5.2 - menu 1). If RF output is disabled, these readings will be zero.

### 5.2.4 How to enable Local mode and the RF output

Check current mode setting and enable Local mode (if not already enabled) following menu path **Fnc** ⇒ **Loc** ⇒ **Local** (figure 5.2): if left disabled, the machine will not accept the next commands.

Check current RF output setting and enable output (if not already enabled) following menu path **Fnc** ⇒ **Pwr** ⇒ **ON** (figure 5.2 - menu 4).

Check output power level and set to maximum level (if not already set to maximum) from the Power Setup Menu, which you can call up by pressing these keys in the order: ESC (opens Default Menu) ⇒ ENTER (hold down for 2 seconds) ⇒ SET ⇒ use key to set bar to maximum limit (figure 5.2 - menu 2).



### 5.2.5 RF output power level control



**IMPORTANT:** *The amplifier incorporates Automatic Gain Control and output power is modulated based on the power level set by the user and actual operating conditions, such as temperature, reflected power and other parameters. Drive power must be kept steady at maximum output power capacity. Please read section 5.3 for more details of RF power modulation.*

Open the **Power Setup Menu** (figure 5.2 - menu 2) pressing the following keys in the order:

**ESC** (opens **Default Menu**) ⇒ **ENTER** (hold down for 2 seconds).

Use the keys  and  in the **SET** menu to set amplifier output power; the setting bar at the side of **SET** provides a graphic indication of power setting; please consider that the forward power readout provided on the display (**FWD: xxxx W**) reflects actual output power reading, **which may be lower than regulated power supply when Automatic Gain Control is running in power supply limitation mode** (please read section 5.3 about RF power supply modulation for more details).



**Note :** *Output power can also be set in a **Pwr OFF** condition; in this condition, (**Fwd**) output power reading on the display will be 0 (zero), whereas the **SET** bar, which you can control using the keys, provides a graphic display of the amount of power that will be delivered the moment you switch back to **Pwr On** state.*

### 5.2.6 Changing the Power Good alarm threshold

Change Forward Power Good alarm setting **PgD** from the **Fnc** menu as desired (factory setting is 50%).

### 5.2.7 Setting equipment I<sup>2</sup>C address

Change the **IIC** address in the **MIX** (Miscellaneous) menu as desired (factory setting is 01).

### 5.2.8 How to enable Remote mode

If you wish to use the telemetry control feature, enable Remote control in the Fnc menu (see section 5.3.1 for details).



**Note :** In the **Remote** mode, all local push-button controls except **Remote/Local** for switching back to Local mode) are disabled . Operating parameter readings are available.

## 5.3 Operation

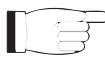

**NOTE:** For better clarity, only the typical screens of **PJ2000LIGHT** are reported below. **PJ1600LIGHT** screens look the same except that full scale values are different.

- 1) Power on the amplifier and ensure that the **ON** light turns on. Machine name should appear briefly on the display, quickly followed by forward and reflected power readings (Menu 1), provided that the amplifier is delivering output power.

```

Fwd:    1.94    KW
Rf1:    12      W
    
```

Menu 1

- 1b) To **modify power level setting**, hold down the **ENTER** button until opening the **power setup menu**.

The edit screen will look like this:

```

SET: ██████████
Fwd:    1.94    KW
    
```

Menu 2

Next to **SET** indication, a bar provides a graphic display of preset output power. The filled portion of the bar is proportional to set power level.

<i>Example</i>		
100% output power	Full bar	≅ 2000W in output (mod.PJ2000LIGHT) ≅ 1600W in output (mod.PJ1600LIGHT)
50% output power	Half bar	≅ 1000W in output (mod.PJ2000LIGHT) ≅ 800W in output (mod.PJ1600LIGHT)

25% output power	1/4 bar	$\cong$ 250W in output (mod.PJ2000LIGHT) $\cong$ 400W in output (mod.PJ1600LIGHT)
------------------	---------	--------------------------------------------------------------------------------------------

The bottom line provides instantaneous power reading (1997W in this instance); press button to increase level, press to decrease it. When you have achieved the desired level, press **ENTER** to confirm and exit the default menu. Please note that the setting is stored automatically; in other words, if you press **ESC** or do not press any keys before the preset time times out, the latest power level set will be retained.



**NOTE:** This feature prevents the machine from delivering maximum power as soon as output is enabled from menu 4, or in the event the machine is already set to **ON** and energised.

- 2) Ensure that machine is not in a locked-out state. Press the **ESC** key (chap. 6.1) to call up the selection screen (Menu 3). Highlight **Fnc** and press **ENTER** to confirm and access the appropriate menu (menu 4).

If **LOC** is set to **REMOTE** (machine remote control), move cursor to **LOC** and press **ENTER**; label will change to **LOCAL**, i.e. local control operation mode.

In the same menu, ensure that power limiting is disabled: if **PWR** is set to **OFF**, i.e. power output is disabled, move cursor to **PWR**. Press **ENTER** and label will switch to **ON**, i.e. power output enabled.

Press **ESC** twice to go back to the **default menu** (menu 1).

- 3) Fine tune power setting from menu 2 (see description of item 1b) until achieving the desired value.



**WARNING:** Machine is capable of delivering more than rated output power (1600/2000 W); however, never exceed the specified power rating.



**NOTE:** Exciter drive power setting should never exceed 30W, or it will trigger an Overdrive Alarm.



**NOTE:** If power is set to 0 W in the **edit mode**, the INTERLOCK OUT contact trips and external exciter power is immediately inhibited.

Next, you can review all operating parameters of the machine through the management firmware.

Normally, the machine can run unattended. Any alarm condition is handled automatically by the safety system or is signalled by the LED indicators on the panel or by display messages.



**NOTE:** Standard factory settings are: output power set to upper limit (unless otherwise specified by customer) and **OFF**.

## 5.4 Management Firmware

The machine features an LCD with two lines by 16 characters that displays a set of menus. Figure 5.2 below provides an overview of machine menus.

The symbols listed below appear in the left portion of the display as appropriate:

- ▬ (Cursor) - Highlights selected (i.e. accessible) menu.
- ▶ (Filled arrow) - Editable parameter marker. This symbol appears in menus that take up more than two lines to aid browsing.
- ▶▶▶ (Three empty arrows) - Parameter is being edited.
- ▶ (Empty arrow) - Current line marker; the parameter in this line cannot be edited. This symbol appears in menus that take up more than two lines to aid browsing.

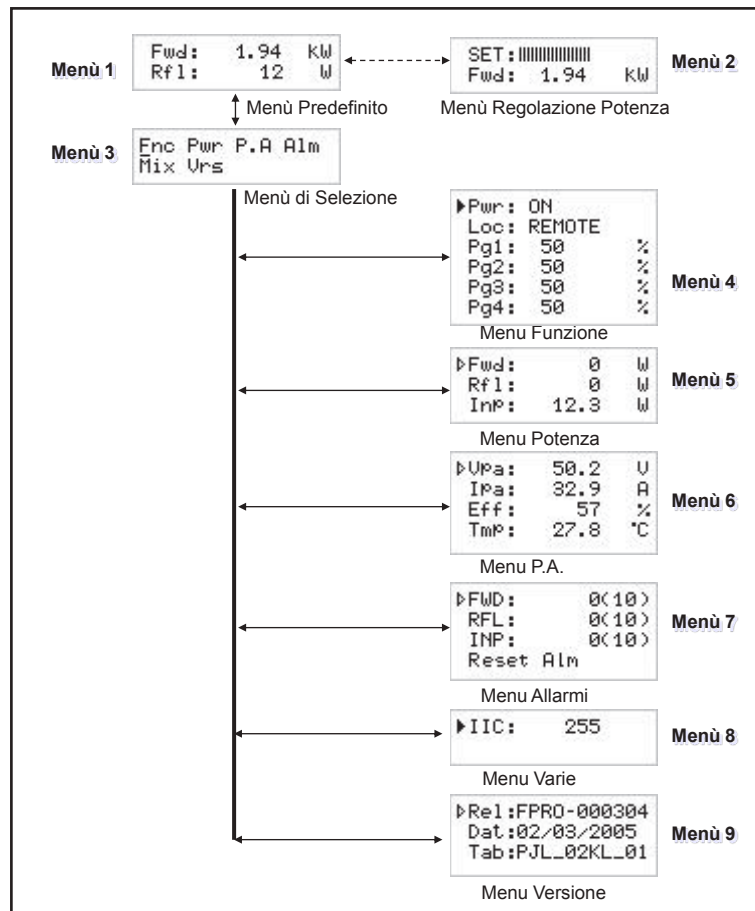

Figure 5.2

When the display is off, touching any key will turn on backlighting.

When the display is on, pressing the **ESC** button from the **default menu** (menu 1) calls up the **selection screen** (menu 3), which gives access to all other menus:



Menu 3

To gain access to a submenu, select menu name (name is highlighted by cursor) using button  $\downarrow$  or  $\leftarrow$  and press the **ENTER** button.

Press **ESC** again to return to the **default menu** (menu 1).

### 5.4.1 Operation Menu (Fnc)

In this menu, you can set **power output** On/Off, toggle between “Local” or “Remote” control mode and set the **Forward Power Good (PgD)** threshold rate.

To edit an item, highlight the appropriate line using the UP and DOWN buttons and then press and hold the **ENTER** button until the command is accepted. This way, Pwr setting is toggled between On and Off and Mod setting is toggled between “x1” and “x10”. To edit the Power Good rate, simply select item “PgD” and edit its value using buttons  $\leftarrow$  and  $\downarrow$ ; finally, press **ENTER** to confirm.

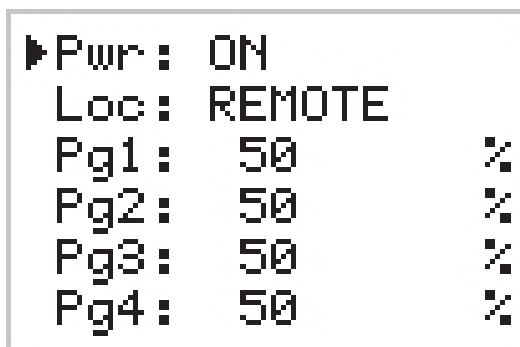

Menu 4

- Pwr Enables (ON) or disables (OFF) amplifier power output.
- Loc Modifies machine operation. In the LOCAL mode, the machine can read and modify its operating parameters through the navigation keys and the management firmware, whereas all other sources are locked out. In the REMOTE mode, the machine can only read its operating parameters; parameters are modified based on the commands received from other connected telemetry systems.



- Pg1 Modifies Power Good (forward power) threshold. The Power Good rate is a percent of machine rated power (1000W for **PJ1000LIGHT** and 2000 W for **PJ2000LIGHT**), not of forward output power. This means that this threshold set at 50% will give 800 and 1000 W regardless of set power level. The Power Good feature enables output power control and reporting. When output power drops below set Power Good threshold, the equipment changes the state of pin [9] of the DB25 “Remote” connector located on the rear panel.
- Pg2 Like Pg1, modifies a second Power Good threshold for forward power. When output power drops below set Power Good threshold, the equipment changes the state of pin [22] of the DB25 “Remote” connector located on the rear panel.
- Pg3 Like Pg1, modifies Power Good threshold for reflected power. When output power drops below set Power Good threshold, the equipment changes the state of pin [18] of the DB25 “Remote” connector located on the rear panel.
- Pg4 Like Pg1, modifies a second Power Good threshold for reflected power.

### 5.4.2 Power Menu (Pwr)

This screen holds all readings related to machine output power:



▷Fwd:	0	W
Rf1:	0	W
InP:	12.3	W

Menu 5

- Fwd Forward power reading.
- Rf1 Reflected power reading.
- Inp Input power reading.

Note that these are readings, rather than settings, and cannot be edited (note the empty arrow). To change power setting, go to the **default menu** (menu 1) as outlined earlier.

### 5.4.3 Power Amplifier (P.A) Menu

This screen is made up of four lines that can be scrolled using the buttons  and , shows the readings relating to final power stage:

```

▶Vpa:    50.2    V
  Ipa:    32.9    A
  Eff:     57     %
  Tmp:    27.8   °C
    
```

Menu 6

Note that these are readings, rather than settings, and cannot be edited (note the empty arrow).

- VPA Voltage supplied to amplifier module.
- IPA Current absorbed to amplifier module.
- Eff Efficiency based on ratio of forward power to amplifier module power in percent ( FWD PWR/(Vpa x Ipa) % ).
- Tmp Machine internal temperature.

#### 5.4.4 Alarm Menu (Alm)

This menu shows any alarm conditions occurring during machine operation. Alarm thresholds are preset at the factory.

```

▶FWD:     0(10)
  RFL:     0(10)
  INP:     0(10)
  Reset Alm
    
```

Menu 7

- FWD Conteggio delle situazioni di allarme dovuti a potenza diretta.
- RFL Conteggio delle situazioni di allarme dovuti a potenza riflessa.
- INP Conteggio delle situazioni di allarme dovuti a potenza in ingresso.
- Reset Alm Reset sulla numerazione delle situazioni di allarme.

Alarm conditions are numbered from 1 to 10 and reflect the following situations: forward output power too high, reflected output power too high and input power too high.

Alarm monitoring cycle is as follows: when an alarm condition is detected, alarm counter increases by 1 unit, machine goes into lock-out state and the display shows

the cause for the stop (chap. 5.4.4.1). After 15 seconds, the machine attempts to re-start; if a new alarm condition is detected, cycle is repeated over and over again up to 10 times maximum.

If machine re-starts successfully, all alarm counters are reset after 30 minutes' regular operation. After 10 alarm conditions triggered by the same cause, the machine goes into fault lock-out mode, a lock-out mode warning appears on the display and the "FAULT" LED turns on.

After the alarm condition has been rectified, the counter can be reset by highlighting "Reset Alm" and holding down the **ENTER** key for some time.

#### 5.4.4.1 Alarms e Faults

There are three types of alarms that can cause a machine lock-out and trigger a "FAULT/LOCK" indication. **When any one of the three alarm thresholds is exceeded, the system will automatically switch to the warning screen (even though the user is browsing system menus) and the following messages are displayed:**

##### 1. Over Forward Power

Forward power threshold exceeded.



```
!! ATTENTION !!
OVER FWD Power
```

*Alarm 1*

##### 2. Over Reflected Power

Reflected power threshold exceeded.



```
!! ATTENTION !!
OVER RFL Power
```

*Alarm 2*

##### 3. Over Input Power

Input power threshold exceeded.



```
!! ATTENTION !!
OVER INP Power
```

*Alarm 3*

Monitoring cycle is as follows:

- An alarm condition occurs;
- Alarm is displayed and device is locked out for 15 sec.;
- Operating conditions are restored;
- Verification.

Upon reaching the 10 cycle limit, a “FAULT” indication is triggered and the device goes into lock-out mode; the appropriate LED turns on (figure 6.1) and this screen is displayed:

## I. Over Forward Power

Forward power alarm display.



*Stop 1*

## II. Over Reflected Power

Reflected power alarm display.



*Stop 2*

## III. Over Input Power

Input power alarm display.



*Stop 3*

Once the machine goes into “FAULT” mode, it will no longer attempt to re-start; choose the appropriate reset procedure according to current machine setting:

- Machine set to LOCAL control mode - press “Reset Alm” in the alarm menu (menu 7) or power off and back on again using the POWER switch.
- Machine set to REMOTE control mode - power off and back on again sending the appropriate command via the DB25 connector (pin [8] and [20]).

There is a fourth alarm that does not trigger a “FAULT” condition, but allows some time until correct operating conditions are restored. When the temperature alarm threshold is exceeded (about 85°C), the following screen appears:

#### 4. Over Temperature

Temperature power threshold exceeded.

```
!! ATTENTION !!
OVER TEMPERATURE
```

Alarm 4

#### 5.4.5 Miscellaneous Menu (Mix)

This menu lets you set machine address in an I<sup>2</sup>C bus serial connection:

```
▶ IIC:      255
```

Menu 8

IIC I<sup>2</sup>C address setting. The I<sup>2</sup>C network address becomes significant when the exciter is connected in an RVR transmission system that uses this protocol. Do not change it unless strictly required.

#### 5.4.6 Version Menu (Vrs)

This screen holds machine version/release information:

```
▶ Rel:FPRO-000304
Dat:02/03/2005
Tab:PJL_02KL_01
```

Menu 9

Note that these are readings, rather than settings, and cannot be edited (note the empty arrow).

- Rel Firmware release information.
- Dat Release date.
- Tab Shows table loaded in the memory.

## 6. Identification and Access to the Modules

The **PJ1600LIGHT** and **PJ2000LIGHT** is made up of various modules linked to each other through connectors so as to make maintenance and any required module replacement easier.

### 6.1 Upper view PJ1600LIGHT

The figure below shows the upper view of the machine with the various components pointed out.

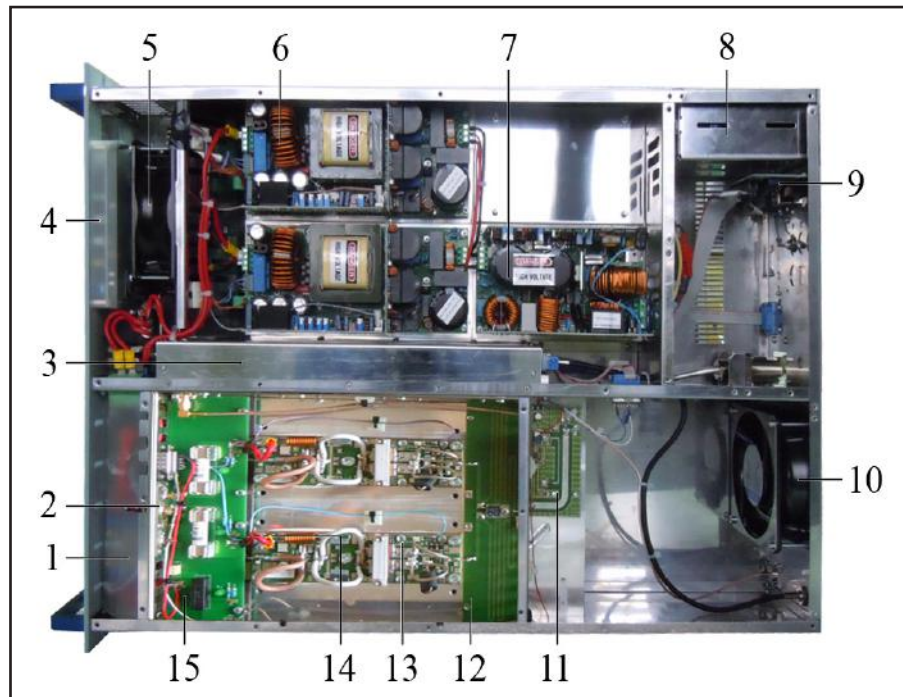

figure 6.1

- [1] Bias Board
- [2] Pass Through Board
- [3] LPF Board
- [4] Panel Board
- [5] Impeller FAN1
- [6] Power supply 50V 60A module
- [7] Power Factor module
- [8] Surge Protection Board
- [9] Telemetry Board
- [10] Impeller FAN2
- [11] PWR Input Measure Board
- [12] Splitter Board
- [13] RF Amplifier Board
- [14] Combiner Board
- [15] Fuse Board

## 6.2 Upper view PJ2000LIGHT

The figure below shows the upper view of the machine with the various components pointed out.

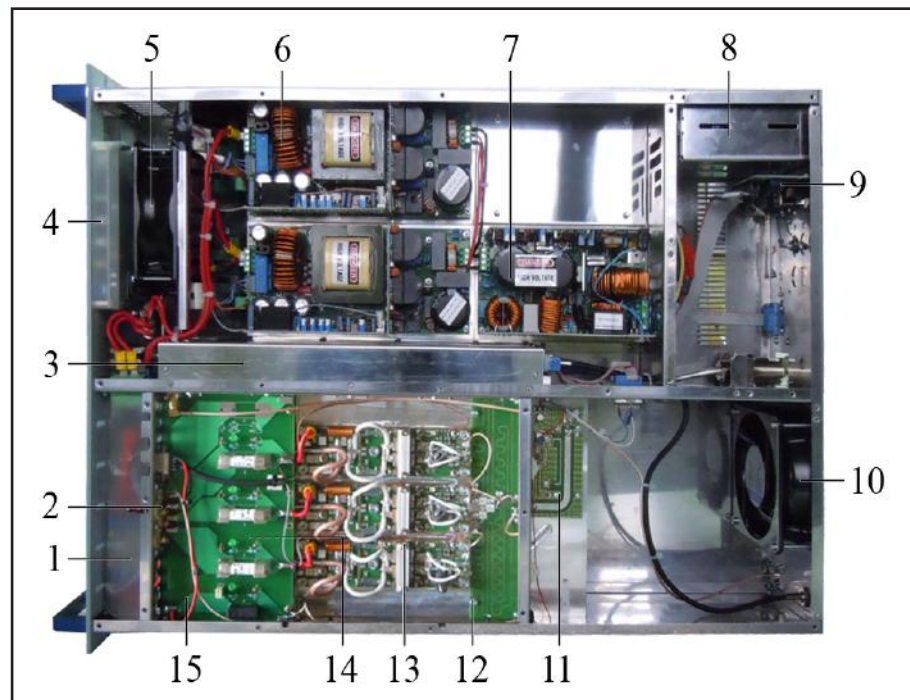

figure 6.2

- [1] Bias Board
- [2] Pass Through Board
- [3] LPF Board
- [4] Panel Board
- [5] Impeller FAN1
- [6] Power supply 50V 60A module
- [7] Power Factor module
- [8] Surge Protection Board
- [9] Telemetry Board
- [10] Impeller FAN2
- [11] PWR Input Measure Board
- [12] Splitter Board
- [13] RF Amplifier Board
- [14] Combiner Board
- [15] Fuse Board

## 6.3 Bottom View PJ1600/2000LIGHT

The figure below shows the bottom view of the machine with the various components pointed out.



figura 6.3

- [1] LED PS Board
- [2] Interface Board
- [3] Power Supply 24V 3A
- [4] Telemetry Board

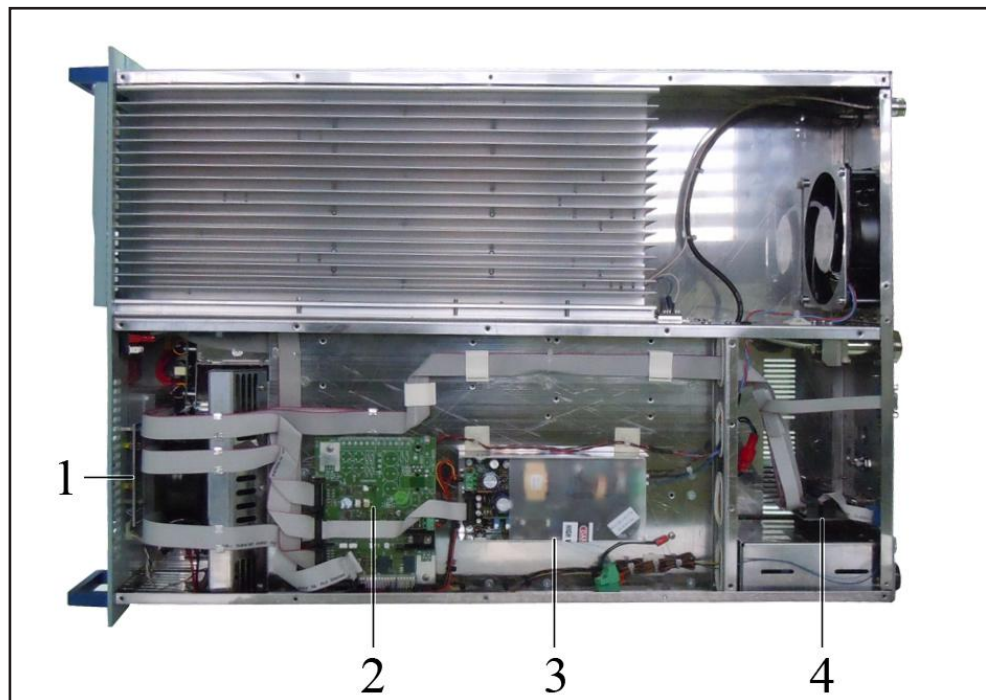

## 7. Working Principles

The figures below provide an overview of **PJ1600LIGHT** (fig. 7.1) and **PJ2000LIGHT** (fig. 7.2) modules and connections.

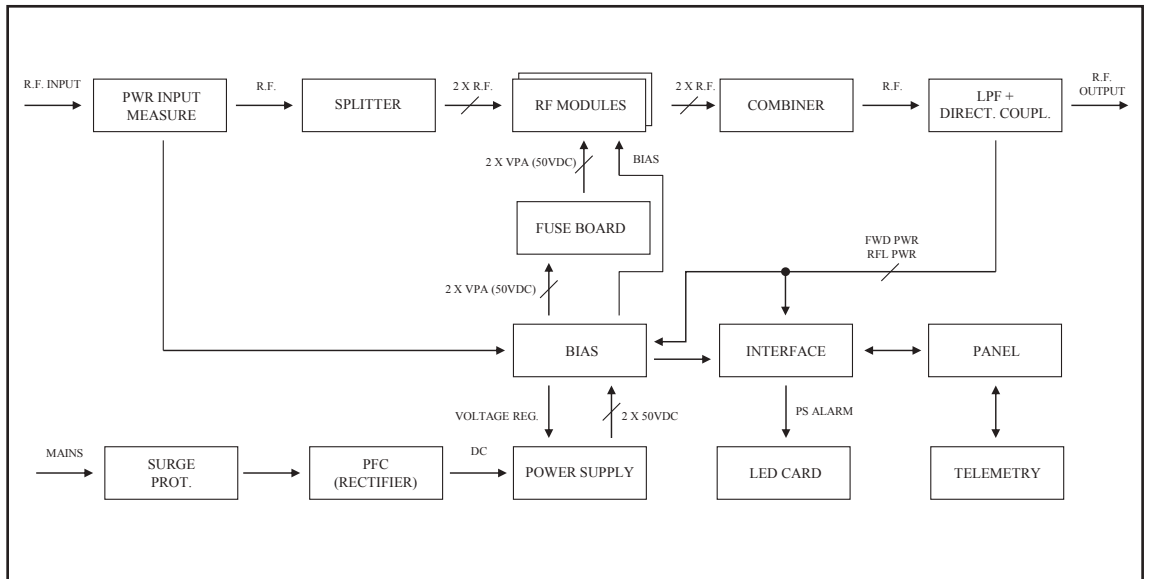

Figure 7.1

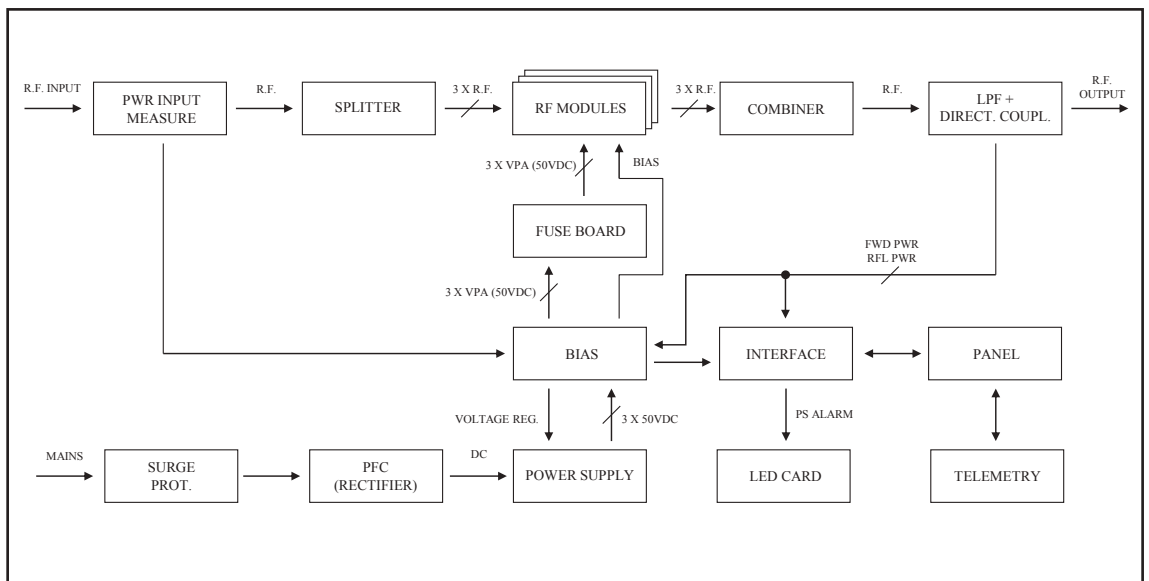

Figure 7.2

Following is a brief description of the different module functions; all diagrams and board layout diagrams are included in the “Technical Schedule” Vol.2.

## 7.1 PJ1600/2000LIGHT Common Parts

### 7.1.1 Panel Board

The panel board accommodates the microcontroller that runs the machine control software and all user interface elements (display, LED's, keys, ...).

This board is interfaced with other machine modules via flat cables and provides for power supply, control signals and measurement distribution.

### 7.1.2 Interface Board

This board performs the following tasks:

- It uses AC voltage to generate and distribute service power supply over the panel board;
- It controls and provides interfacing of the mains surge protection module;
- It controls and provides interfacing of the power amplifier supply module;
- It processes and provides interfacing of the control signals to/from the Bias Board;
- It processes and provides interfacing of the control signals to/from the Panel Board.
- It feeds and operates the cooling fans;
- It feeds and controls the LED indicator board.

### 7.1.3 Telemetry board

This board provides an I/O interface for the CPU with the outside environment. All available machine input and output signals are brought to the REMOTE DB25 connector.

Also mounted on this board is the INTERLOCK IN BNC connector which can disable device power output. When the central pin is closed to ground, output power is limited to zero until ground connection is removed.

### 7.1.4 Mains power supply pulse protection

This module is enclosed in a sealed metal case; it features two externally mounted mains fuses and accommodates a bank of surge arresters that protect the machine from any surge events in the power mains.

Mains voltage is brought from this module to the main Power switch on the front panel, which relays it to the service transformer TR1.

Inside the surge protection module, a suitable 24VDC relay controlled via the interface board isolates (single line) mains voltage to be fed to the power amplifier power supply unit (PFC module). This way, mains power supply to PFC is enabled when these requirements are met:

- POWER switch on front panel set to ON;
- No alarm or fault events present;
- Power output enabled (set to ON) in FNC operation menu;
- RF output power set to over 0W using the edit mode.

### 7.1.5 PWR Input Measure Board

This card makes two check and measure functions:

- Input power measure, measure send to interface card that supplies to send machine in protection mode in case of input power excess.
- Temperature measure.

### 7.1.6 Power Supply

The **PJ1600/2000LIGHT** power supply sections is made up of a surge protection module and two power supply units:

1. **Surge Protection:** Surge Protection board protects machine from eventual unexpected variations of the mains voltage.
2. **Service:** This section contains elements that do not regard directly the power supply, they are::
  - Service transformer
  - Power switch
  - Service fuse
2. **Power supply:** various units supplies an adapted supply to RF power amplifier modules. The units that compose power supply are rectifiers (PFC or traditional) and switching supply. Machine is available in different configuration for voltage rectify:
  - One PFC

## 7.1.6.1 PFC unit

PFC units are rectifiers that modulates absorbed current so that the wave shape is sinusoidal, having so 99% power factor.

PFC can work with input mains voltage from 90 V to 250 V. When you use it with mains voltage of 110 V, is necessary to install two PFC units because there is a lot of absorbed current. In PFC output there are 350 V of rectified voltage.

## 7.1.6.2 Power supply

There is a power supply switching mode of 50 V 60 A, that have an input voltage check. Output voltage is set from microprocessor in function of RF power required.

The power supply units have a balance current circuit.

## 7.1.7 Power Amplifier

RF power amplifier section is made with four power amplifier modules combined through a Wilkinson splitter and a Wilkinson combiner in strip-line technology.

The splitter is used to divide input power from PWR Input Measure card and to supply a part of it to every RF module. The combiner is used to combine output power from every RF module so as to have total power amplifier.

Splitter, amplifier and combiner are plans so that powers generated from the amplifiers add its in phase, diminishing the loss of balance and therefore the dissipation of useful power.

All RF section is placed on a fin that supplies to the cooling through forced ventilation.

Every RF module supplies 850 watts ( two in **PJ1600LIGHT** model, or three in **PJ2000LIGHT** model) and is supplied from own switching supply.

The active device used in the amplifier modules is a Mosfet (MRF6VP11KH for **PJ1600/2000LIGHT** model).

### 7.1.8 LPF card

This card is a low-pass filter and its function is to suppress the harmonic components generated by the amplifier below the levels required by regulations.

Moreover, in the end of filter, there is a directional coupler, its function is the measurement of the forward and reflected output power.

On this card there is an RF sample at -60 dB compared with the output and it is available on a BNC connector. This sample is useful for checking the characteristics of the carrier, but not of the higher order harmonics.

### 7.1.9 LPF card

Main function, of this card, is to check and to correct the polarization voltage (BIAS) of Mosfet in RF amplifier section.

Moreover it supplies the measure of the absorbed current as sum of the absorbed currents from every module and it contains a circuit for the signalling of the breakdowns in the Power Supply.

Without alarm condition, Bias voltage is regulated only in function of output power set up, with a feedback mechanism based on the reading of the effectively distributed power (AGC).

Bias voltage is also influenced from other factors like:

- Excess of reflected voltage
- External AGC signals (Ext. AGC FWD, Ext. AGC RFL,...)
- Excess of temperature
- Excess of absorbed current from a RF module.

*This page was intentionally left blank*





**R.V.R. Elettronica S.p.A.**

Via del Fonditore, 2 / 2c  
Zona Industriale Roveri · 40138 Bologna · Italy  
Phone: +39 051 6010506 · Fax: +39 051 6011104  
e-mail: [info@rvr.it](mailto:info@rvr.it) · web: <http://www.rvr.it>

ISO 9001:2000 certified since 2000



The RVR Logo, and others referenced RVR products and services are trademarks of RVR Elettronica S.p.A. in Italy, other countries or both. RVR ® 1998 all rights reserved.  
All other trademarks, trade names or logos used are property of their respective owners.