

PJ1000-LIGHT

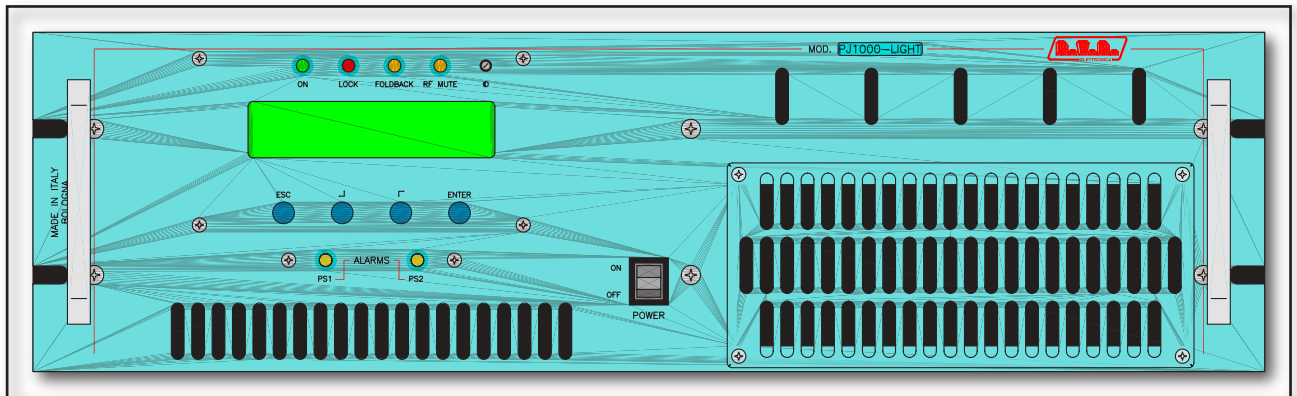

User Manual Volume 1

Manufactured by



Italy



File Name: 03_PJ1000light_ING_1.3.indd

Version: 1.3

Date: 24/02/2016

Revision History

Date	Version	Reason	Editor
14/11/05	1.0	First Edition	F. Ballarani
12/12/05	1.1	Power Supply Upgrade	J. H. Berti
17/07/06	1.2	Card Code Upgrade	J. H. Berti
24/02/16	1.3	Menu Updates	J. H. Berti

PJ1000-LIGHT - User Manual
Version 1.3

© Copyright 2005 - 2016

R.V.R. Elettronica SpA

Via del Fonditore 2/2c - 40138 - Bologna (Italia)

Telephone: +39 051 6010506

Fax: +39 051 6011104

Email: info@rvr.it

Web: www.rvr.it

All rights reserved

Printed and bound in Italy. No part of this manual may be reproduced, memorized or transmitted in any form or by any means, electronic or mechanic, including photocopying, recording or by any information storage and retrieval system, without written permission of the copyright owner.

Notification of intended purpose and limitations of product use

This product is a FM transmitter intended for FM audio broadcasting. It utilises operating frequencies not harmonised in the intended countries of use.

The user must obtain a license before using the product in intended country of use. Ensure respective country licensing requirements are complied with.

Limitations of use can apply in respect of operating frequency, transmitter power and/or channel spacing.

Declaration of Conformity

Hereby, R.V.R. Elettronica SpA, declares that this FM transmitter is in compliance with the essential requirements and other relevant provisions of Directive 1999/5/EC.



Sommario

1.	Istruzioni preliminari	1
2.	Garanzia	1
3.	Primo soccorso	1
3.1	Trattamento degli shock elettrici	1
3.2	Trattamento delle ustioni elettriche	2
4.	Rimozione dell'Imballaggio	3
4.1	Descrizione Generale	3
5.	Procedura di installazione e configurazione	5
5.1	Preparazione	5
5.2	Prima accensione e impostazione del funzionamento	8
5.3	Uso	11
5.4	Firmware di Gestione	12
6.	Descrizione Esterna	20
6.1	Pannello Frontale	20
6.2	Pannello Posteriore	21
6.3	Descrizione Connettori	21
7.	Specifiche Tecniche	24
7.1	Caratteristiche meccaniche	24
7.2	Caratteristiche elettriche	24
7.3	Parti di Ricambio	25
8.	Principi di funzionamento	26
8.1	Alimentazione	26
8.2	Scheda di Interfaccia (SL010IN3001)	28
8.3	Scheda pannello - CPU (SL007PC2001B)	28
8.4	Scheda Misura Potenza in ingresso (PWR Input Measure)	28
8.5	Amplificatore di potenza	29
8.6	Scheda LPF (SLLPFTEX1KL)	29
8.7	Scheda BIAS (SLBIAS1K3U-2)	30
8.8	Scheda Interfaccia di Telemetria Esterna (SLTLMTXLCD03)	30
9.	Identificazione dei Moduli	31
9.1	Vista dall'alto	31
9.2	Vista dal basso	32

Pagina lasciata intenzionalmente in bianco

1. Preliminary Instructions

This manual is written as a general guide for those having previous knowledge and experience with this kind of equipment, well conscious of the risks connected with the operation of electrical equipment.

It is not intended to contain a complete statement of all safety rules which should be observed by personnel in using this or other electronic equipment.

The installation, use and maintenance of this piece of equipment involve risks both for the personnel performing them and for the device itself, that shall be used only by trained personnel.

R.V.R. Elettronica SpA doesn't assume responsibility for injury or damage resulting from improper procedures or practices by untrained/unqualified personnel in the handling of this unit.

Please observe all local codes and fire protection standards in the operations of this unit.



WARNING: always disconnect power before opening covers or removing any part of this unit.

Please observe all local codes and fire protection standards in the operations of this unit.



WARNING: this device can irradiate radio frequency waves, and if it's not installed following the instructions contained in the manual and local regulations it could generate interferences in radio communications.

This is a "CLASS A" equipment. In a residential place this equipment can cause hash. In this case can be requested to user to take the necessary measures.

R.V.R. Elettronica SpA reserves the right to modify the design and/or the technical specifications of the product and this manual without notice.

2. Warranty

Any product of **R.V.R. Elettronica** is covered by a 24 (twenty-four) month warranty.

For components like tubes for power amplifiers, the original manufacturer's warranty applies.

R.V.R. Elettronica SpA extends to the original end-user purchaser all manufacturers warranties which are transferrable and all claims are to be made directly to R.V.R. per indicated procedures.

Warranty shall not include:

- 1 Re-shipment of the unit to R.V.R. for repair purposes;
- 2 Any unauthorized repair/modification;
- 3 Incidental/consequential damages as a result of any defect;
- 4 Nominal non-incidentual defects;
- 5 Re-shipment costs or insurance of the unit or replacement units/parts.

Any damage to the goods must be reported to the carrier in writing on the shipment receipt.

Any discrepancy or damage discovered subsequent to delivery, shall be reported to **R.V.R. Elettronica** within **5** (five) days from delivery date.

To claim your rights under this warranty, you should follow this procedure:

- 1 Contact the dealer or distributor where you purchased the unit. Describe the problem and, so that a possible easy solution can be detected.

Dealers and Distributors are supplied with all the information about problems that may occur and usually they can repair the unit quicker than what the manufacturer could do. Very often installing errors are discovered by dealers.

- 2 If your dealer cannot help you, contact **R.V.R. Elettronica** and explain the problem. If it is decided to return the unit to the factory, **R.V.R. Elettronica** will mail you a regular authorization with all the necessary instructions to send back the goods;
- 3 When you receive the authorization, you can return the unit. Pack it carefully for the shipment, preferably using the original packing and seal the package perfectly. The customer always assumes the risks of loss (i.e., R.V.R. is never responsible for damage or loss), until the package reaches R.V.R. premises. For this reason, we suggest you to insure the goods for the whole value. Shipment must be effected C.I.F. (PREPAID) to the address specified by R.V.R.'s service manager on the authorization



DO NOT RETURN UNITS WITHOUT OUR AUTHORIZATION AS THEY WILL BE REFUSED

- 4 Be sure to enclose a written technical report where mention all the problems found and a copy of your original invoice establishing the starting date of the warranty.

Replacement and warranty parts may be ordered from the following address. Be sure to include the equipment model and serial number as well as part description and part number.



R.V.R. Elettronica SpA
Via del Fonditore, 2/2c
40138 BOLOGNA
ITALY
Tel. +39 051 6010506

3. First Aid

The personnel employed in the installation, use and maintenance of the device, shall be familiar with theory and practice of first aid.

3.1 Treatment of electrical shocks

3.1.1 If the victim is not responsive

Follow the A-B-C's of basic life support.

- Place victim flat on his back on a hard surface.
- Open airway: lift up neck, push forehead back (**Figure 1**).

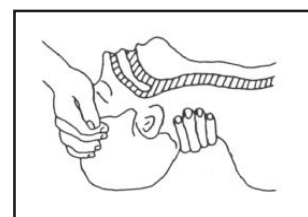

Figure 1

- clear out mouth if necessary and observe for breathing
- if not breathing, begin artificial breathing (**Figure 2**): tilt head, pinch nostrils, make airtight seal, four quick full breaths. Remember mouth to mouth resuscitation must be commenced as soon as possible.



Figure 2

- Check carotid pulse (**Figure 3**); if pulse is absent, begin artificial circulation (**Figure 4**) depressing sternum (**Figure 5**).

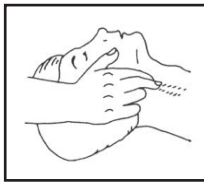

Figure 3

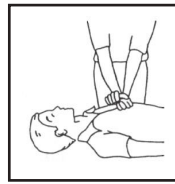

Figure 4

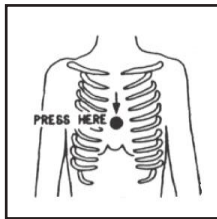

Figure 5

- In case of only one rescuer, 15 compressions alternated to two breaths.
- If there are two rescuers, the rhythm shall be of one breath each 5 compressions.
- Do not interrupt the rhythm of compressions when the second person is giving breath.
- Call for medical assistance as soon as possible.

3.1.2 If victim is responsive

- Keep them warm.
- Keep them as quiet as possible.
- Loosen their clothing (a reclining position is recommended).
- Call for medical help as soon as possible.

3.2 Treatment of electrical Burns

3.2.1 Extensive burned and broken skin

- Cover area with clean sheet or cloth.
- Do not break blisters, remove tissue, remove adhered particles of clothing, or apply any salve or ointment.

- Treat victim for shock as required.
- Arrange transportation to a hospital as quickly as possible.
- If arms or legs are affected keep them elevated.

If medical help will not be available within an hour and the victim is conscious and not vomiting, give him a weak solution of salt and soda: 1 level teaspoonful of salt and 1/2 level teaspoonful of baking soda to each quart of water (neither hot or cold).

Allow victim to sip slowly about 4 ounces (half a glass) over a period of 15 minutes.

Discontinue fluid if vomiting occurs.

DO NOT give alcohol.

3.2.2 Less severe burns

- Apply cool (not ice cold) compresses using the cleansed available cloth article.
- Do not break blisters, remove tissue, remove adhered particles of clothing, or apply salve or ointment.
- Apply clean dry dressing if necessary.
- Treat victim for shock as required.
- Arrange transportation to a hospital as quickly as possible.
- If arms or legs are affected keep them elevated.

4. Unpacking

The package contains:

- 1 **PJ1000-LIGHT**
- 1 User Manual
- 1 Mains power cable

The following accessories are also available from Your R.V.R. Dealer:

- **Accessories, spare parts and cables**

4.1 General Description

The **PJ1000-LIGHT** is an **radio broadcasting amplifier** manufactured by **R.V.R. Elettronica SpA** featuring adjustable RF power output up to 1000 W under 50 Ohm standard load and less than 20W drive power requirement.

The **PJ1000-LIGHT** has been designed for installation in a 19"x3HE box for rack.

The amplifier incorporates a low-pass filter to keep harmonics below the limits provided for by international standards (CCIR, FCC or ETSI).



Two major features of **PJ1000-LIGHT** are compact design and user-friendliness. Another key feature is its modular-concept design: the different functions are performed by modules with most connections achieved through male and female connectors or through flat cables terminated by connectors. This design facilitates maintenance and module replacement.

The RF power section used three MOSFET modules, each with 350 W output capacity.

An LCD on the front panel and a push-button panel provide for user interfacing with the microprocessor control system, which implements the following features:

- Output power setup
- Power output enable/disable
- User-selectable threshold settings for output power alarm (Power Good feature)
- Measurement and display of amplifier operating parameters
- Communication with external devices, as programming systems or telemetry systems through RS232 or I²C serial interface

Four LEDs on the front panel provide for machine status indication (ON, FAULT/ LOCK, FOLDBACK, RF MUTE) and two yellow LEDs provide Power Supply fault indication.

The amplifier management software is based on a menu system. User has four navigation buttons available to browse submenus: **ESC** (chap. 6.1 - [6]), , , , and **ENTER** (chap. 6.1 - [9]).

The rear panel features the mains input connectors with a mains voltage switch (chap. 6.2 - [18]) to select the appropriate mains input voltage, RF input and output connectors, telemetry connector, protection fuses, interlock input and output connectors and a BNC connector that provides an RF test point with level being -60 dB lower than power output.

5. Quick guide for installation and use

This section provides a step-by-step description of the machine installation and configuration procedure. Follow these procedures closely upon first power-on and each time any change is made to general configuration, such as when a new transmission station is added or the exciter is replaced.

Once the desired configuration has been set up, no more settings are required for normal operation; at each power-up (even after an accidental shutdown), the amplifier defaults to the parameters set during the initial configuration procedure.

The topics covered in this section are discussed at greater length in the next sections, with detailed descriptions of all hardware and firmware features and capabilities. Please see the relevant sections for additional details.



IMPORTANT: When configuring and testing the transmitter in which the amplifier is integrated, be sure to have the Final Test Table supplied with the machine ready at hand throughout the whole procedure; the Final Test Table lists all operating parameters as set and tested at the factory.

5.1 Preparation

5.1.1 Preliminary checks

Unpack the amplifier and immediately inspect it for transport damage. Ensure that all connectors are in perfect condition.

Provide for the following (applicable to operating tests and putting into service):

- √ Single-phase 230 VAC or 115 VAC (-15% / +10%) mains power supply with adequate ground connection
- √ FM exciter with adjustable output power up to 20W (as a minimum), like RVR Elettronica PTX30-LCD
- √ For operating tests only: dummy load with 50 Ohm impedance and adequate capacity (1000 W as a minimum)
- √ Connection cable kit including:
 - Mains power cable
 - Coaxial cable with BNC connectors for interlock signal connection between exciter and amplifier
 - RF connection cable between exciter and amplifier (50 Ohm coaxial cable with “N”-type connectors)
 - RF cable for output to load / antenna (50 Ohm coaxial cable with 7/8” connectors as standard, or optional 7/16” connectors)

5.1.2 Mains power supply



WARNING: Disconnect mains power supply before beginning these procedures.

Both power supply units (please see chapter 8.1 for a detailed description) are equipped with fuses and voltage selection blocks: **check all fuses and voltage selection blocks to ensure they are properly rated for the power mains and change them as required to match mains voltage.**

All mains power supply protection fuses are conveniently located on the rear panel and are easily accessed (see figure 6.2): to check or replace a fuse, **disconnect machine from power mains**, unscrew fuse cover and pull fuse out of socket.

The following fuses are used:

	@ 230 Vac	@ 115 Vac
Main Power Supply (fig. 6.2 - item [7] e [20])	(2x) 25A type 10x38	(2x) 25A type 10x38
Service power supply (fig. 6.2 - item [19])	(1x) 2A type 5x20	(1x) 2A type 5x20

Table 5.1: Fuses

Ensure that machine is appropriately set for available mains voltage (supply voltage rating is reported in the Final Test Table) as follows: **disconnect machine from mains** and ensure that the voltage selection block of the power supply located on the rear panel (see fig. 6.2 - item [18]) is set to the appropriate voltage; change setting as required.

The main power supply unit is the full-range type and requires no voltage setup.

When supply voltage is other than 230 Vac and might cause erratic operation (say, less than 200 Vac), it may help to move jumper JP3 on the PFC controller board from position 2-3 to 1-2 (see PFCPSL1000 diagram, item [6] in figure 9.1 and detail in figure 5.1 below).

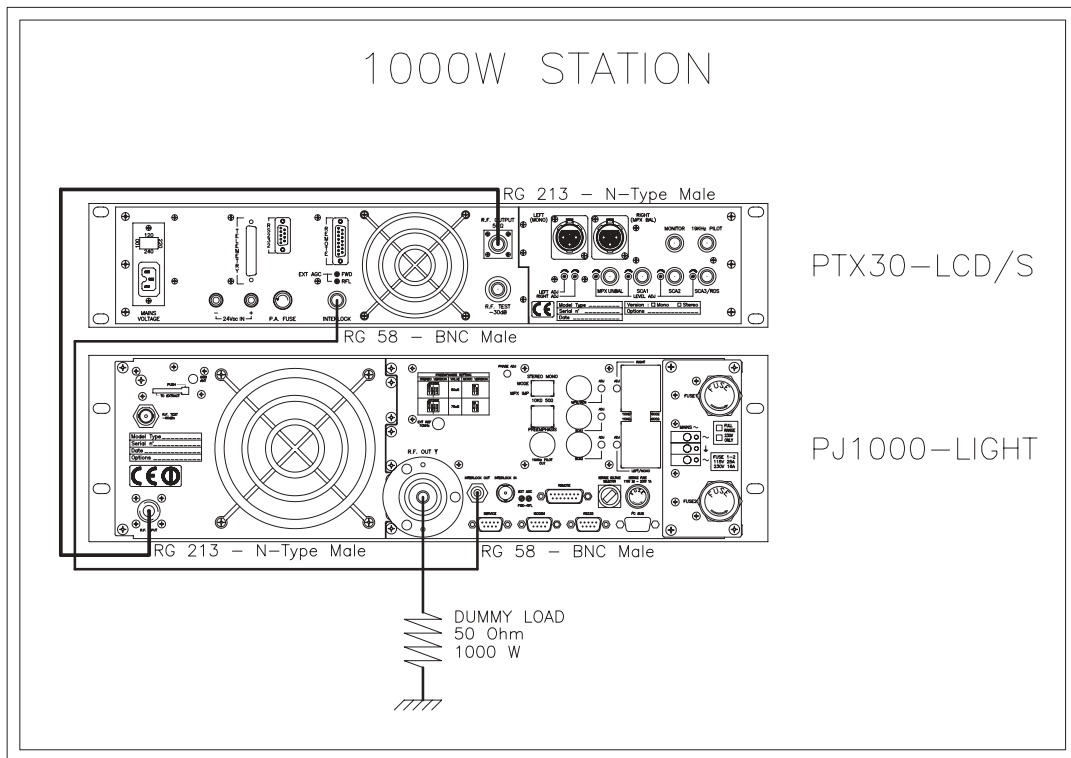

Figure 5.2: Connection to exciter

5.2 First power-on and setup

Follow this procedure upon first power-on and after making changes to the configuration of the transmitter in which the amplifier is integrated.



Note : Standard factory settings are RF power output Off (**Pwr OFF**) and output power set to upper limit (unless otherwise specified by customer).

5.1.2 Pilot exciter setup

Set up the pilot exciter so that the output power it delivers to a matched load equals the maximum input power indicated in the amplifier **final test table**, switch off the exciter and connect it to the amplifier.

5.2.2 Power-on

When you have performed all of the connections described in the previous paragraph, power on the amplifier using the suitable power switch on the front panel (figure 6.1 - item [11]). Power on the pilot exciter.

5.2.3 Power check

Ensure that the **ON** light turns on (see figure 6.1 - item [1]). Machine name should appear briefly on the display, quickly followed by forward and reflected power readings (figure 5.2 - menu 1). If RF output is disabled, these readings will be zero.

5.2.4 How to enable Local mode and RF output

Check current mode setting and enable **Local mode** (if not already enabled) following menu path **Fnc** ⇒ **Loc** ⇒ **Local** (figure 5.2 - menu 4): if left disabled, the machine will not accept the next commands.

Check current **RF** output setting and enable output (if not already enabled) following menu path **Fnc** ⇒ **Pwr** ⇒ **ON** (figure 5.2 - menu 4)

Check output power level and set to maximum level (if not already set to maximum) from the Power Setup Menu, which you can call up by pressing these keys in the order: **ESC** (opens **Default Menu**) ⇒ **ENTER** (hold down for 2 seconds) ⇒ **SET** ⇒ use key to set bar to maximum limit (figure 5.2 - menu 2).

5.2.5 Input power check and setup

Go to **Pwr** menu (figure 5.2 - menu 5) and look up forward output power **Fwd**, reflected power **Rfl** and input power **Inp** readings.

With drive power set as specified in the **Final Test Table**, amplifier output power should be 1000W or higher: if needed, fine tune drive power until achieving rated output power. Never exceed 1100W output power.



Note : Normally, drive power should not exceed 20W (typically 18W): higher drive power requirements are a symptom of abnormal operation.



WARNING: Drive power levels above 20W (typically 25W), result in exceeding input power, which causes a temporary amplifier lock-out (see section 5.3.4.1 - Alarms and Faults for more details).



5.2.6 RF output power level control



IMPORTANT: The amplifier incorporates Automatic Gain Control and output power is modulated based on the power level set by the user and actual operating conditions, such as temperature, reflected power and other parameters. Drive power must be kept steady at maximum output power capacity. Please read section 5.3 for more details of RF power modulation.

Open the **Power setup menu** (figure 5.2 - menu 2) pressing the following keys in the order:

ESC (opens **Default Menu**) ⇒ **ENTER** (hold down for 2 seconds)

Use **SET** menu  and  keys to set the desired amplifier output power; the SET bar at the side provides a graphic display of set power, whereas the forward power value shown on the display (**Fwd: xxxx W**) gives actual output power reading, **and may be lower than set power if an Automatic Gain Control is in limited-power mode** (please read section 5.3 concerning RF power modulation for more details”.



Note : Output power can also be set in a **Pwr OFF** condition; in this condition, (**Fwd**) output power reading on the display will be 0 (zero), whereas the **SET** bar, which you can control using the keys, provides a graphic display of the amount of power that will be delivered the moment you switch back to **Pwr ON** state.

5.2.7 Changing the Power Good alarm threshold

Change Forward Power Good alarm setting **PgD** from the **Fnc** menu as required (factory setting is 50%).

Please read section 5.3.1 for more details.

5.2.8 Changing machine I²C address

Change the **IIC** address in the **Mix** menu as required (factory setting is 01).

Please read section 5.3.5 for more details.

5.2.9 How to enable Remote mode

If you wish to use the telemetry control feature, enable Remote control in the **Fnc** menu (see section 5.3.1 for details).



Note : In the **Remote** mode, all local push-button controls except **Remote/Local** (for switching back to Local mode) are disabled . Operating parameter readings are available.

5.3 Operation

- 1) Power on the amplifier (chap. 6.1 - [11]) and ensure that the **ON** light turns on (chap. 6.1 - [1]). Machine name should appear briefly on the display, quickly followed by forward and reflected power readings (Menu 1), provided that the amplifier is delivering output power.

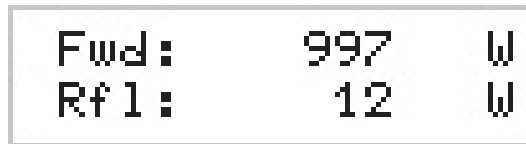

Menu 1

- 1b) To **modify power level setting**, hold down the **ENTER** button until opening the **power setup menu**.



The edit screen will look like this:



Menu 2

Next to **SET** indication, a bar provides a graphic display of preset output power. The filled portion of the bar is proportional to set power level.

<i>Example</i>		
100% output power	Full bar	≅ 1000W in output
50% output power	Half bar	≅ 500W in output
25% output power	1/4 bar	≅ 250W in output

The bottom line provides instantaneous power reading (997W in this instance); press button  to increase level, press  to decrease it. When you have achieved the desired level, press **ENTER** to confirm and exit the default menu. Please note that the setting is stored automatically; in other words, if you press **ESC** or do not press any keys before the preset time times out, the latest power level set will be retained.



NOTE: This feature prevents the machine from delivering maximum power as soon as output is enabled from menu 4, or in the event the machine is already set to **ON** and energised.

- 2) Ensure that machine is not in a locked-out state. Press the **ESC** key (chap. 6.1 - [6]) to call up the selection screen (Menu 3). Highlight **Fnc** and press **ENTER** to confirm (chap. 6.1 - [9]) and access the appropriate menu (menu 4).

If **LOC** is set to **REMOTE** (machine remote control), move cursor to **LOC** and press **ENTER** (chap. 6.1 - [9]); label will change to **LOCAL**, i.e. local control operation mode.

In the same menu, ensure that power limiting is disabled: if **PWR** is set to **OFF**, i.e. power output is disabled, move cursor to **PWR**. Press **ENTER** (chap. 6.1 - [9]) and label will switch to **ON**, i.e. power output enabled.

Press **ESC** (chap. 6.1 - [6]) twice to go back to the **default menu** (menu 1).

- 3) Fine tune power setting from menu 2 (see description of item 1b) until achieving the desired value.



WARNING: Machine is capable of delivering more than rated output power (1000 W); however, never exceed the specified power rating.



NOTE: Exciter drive power setting should never exceed 20W, or it will trigger an Overdrive Alarm.



NOTE: If power is set to 0 W in the **edit mode**, the INTERLOCK OUT contact (chap. 6.2 - [10]) trips and external exciter power is immediately inhibited.

Next, you can review all operating parameters of the machine through the management firmware.

Normally, the machine can run unattended. Any alarm condition is handled automatically by the safety system or is signalled by the LED indicators on the panel or by display messages.



NOTE: Standard factory settings are: output power set to upper limit (unless otherwise specified by customer) and **OFF**.

5.4 Management Firmware

The machine features an LCD with two lines by 16 characters that displays a set of menus. Figure 5.2 below provides an overview of machine menus.

The symbols listed below appear in the left portion of the display as appropriate:

- (Cursor) - Highlights selected (i.e. accessible) menu.
- ▶ (Filled arrow) - Editable parameter marker. This symbol appears in menus that take up more than two lines to aid browsing.

- ▶▶▶ (Three empty arrows) - Parameter is being edited.
- ▶ (Empty arrow) - Current line marker; the parameter in this line cannot be edited. This symbol appears in menus that take up more than two lines to aid browsing.

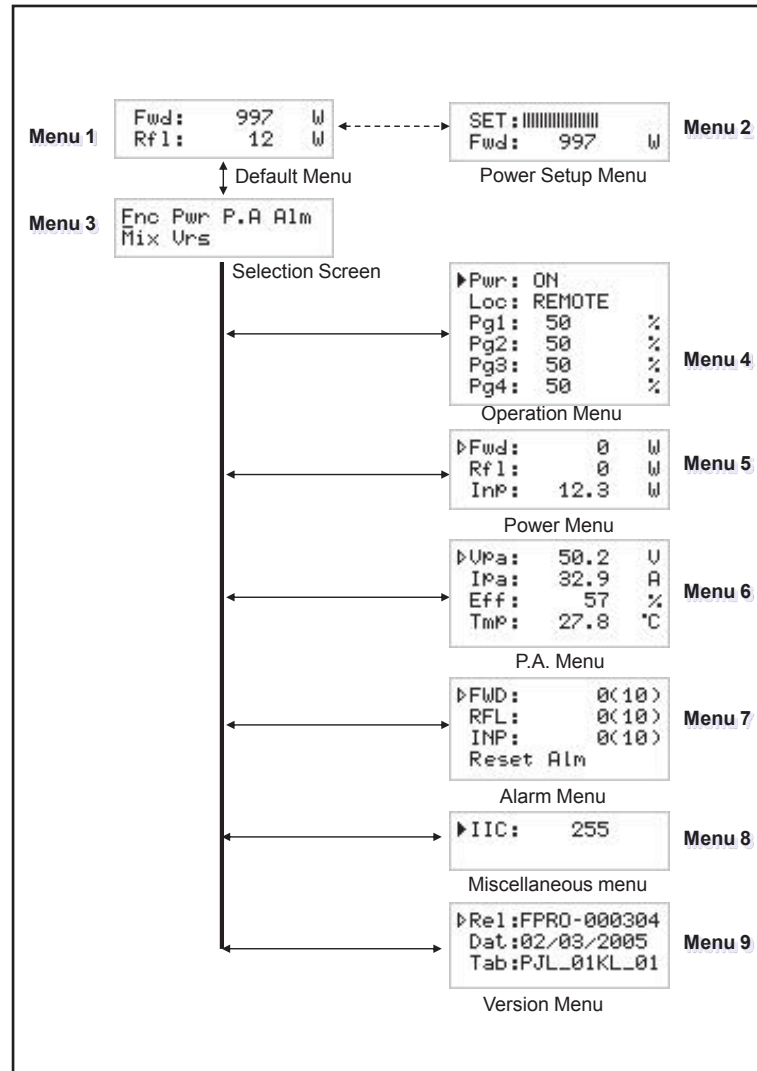

Figure 5.2

When the display is off, touching any key will turn on backlighting.

When the display is on, pressing the **ESC** button (chap. 6.1 - [6]) from the **default menu** (menu 1) calls up the **selection screen** (menu 3), which gives access to all other menus:

```

Enc Pwr P.A Alm
Mix Urs
  
```



Menu 3

To gain access to a submenu, select menu name (name is highlighted by cursor) using button  or  and press the **ENTER** button (chap. 6.1 - [9]).

Press **ESC** again (chap. 6.1 - [6]) to return to the **default menu** (menu 1).

5.4.1 Operation Menu (Fnc)

In this menu, you can set **power output** On/Off, toggle between “Local” or “Remote” control mode and set the **Forward Power Good (PgD)** threshold rate.

To edit an item, highlight the appropriate line using the UP and DOWN buttons and then press and hold the **ENTER** button (chap. 6.1 - [9]) until the command is accepted. This way, Pwr setting is toggled between On and Off and Mod setting is toggled between “x1” and “x10”. To edit the Power Good rate, simply select item “PgD” and edit its value using buttons  and  ; finally, press **ENTER** to confirm (chap. 6.1 - [9]).

```

▶Pwr : ON
  Loc : REMOTE
  Pg1 : 50      %
  Pg2 : 50      %
  Pg3 : 50      %
  Pg4 : 50      %
    
```

Menu 4

- Pwr Enables (ON) or disables (OFF) amplifier power output.
- Loc Modifies machine operation. In the LOCAL mode, the machine can read and modify its operating parameters through the navigation keys and the management firmware, whereas all other sources are locked out. In the REMOTE mode, the machine can only read its operating parameters; parameters are modified based on the commands received from other connected telemetry systems.
- Pg1 Modifies Power Good (forward power) threshold. The Power Good rate is a percent of machine rated power (1000 W), not of forward output power. This means that this threshold set at 50% will give 500 W regardless of set power level. The Power Good feature enables output power control and reporting. When output power drops below set Power Good threshold, the equipment changes the state of pin [9] of the DB25 “Remote” connector located on the rear panel.
- Pg2 Like Pg1, modifies a second Power Good threshold for forward power. When output power drops below set Power Good threshold, the equipment changes the state of pin [22] of the DB25 “Remote” connector located on the rear panel.

- Pg3 Like Pg1, modifies Power Good threshold for reflected power. When output power drops below set Power Good threshold, the equipment changes the state of pin [18] of the DB25 “Remote” connector located on the rear panel.
- Pg4 Like Pg1, modifies a second Power Good threshold for reflected power.

5.4.2 Power Menu (Pwr)

This screen holds all readings related to machine output power:

```



▶Fwd:      0      W
Rfl:      0      W
InP:     12.3     W
    
```

Menu 5

- Fwd Forward power reading.
- Rfl Reflected power reading.
- Inp Input power reading.

Note that these are readings, rather than settings, and cannot be edited (note the empty arrow). To change power setting, go to the **default menu** (menu 1) as outlined earlier.

5.4.3 Power Amplifier (P.A) Menu

This screen is made up of four lines that can be scrolled using the buttons  and  and , shows the readings relating to final power stage:

```

▶Upa:     50.2     V
Ipa:     32.9     A
Eff:       57     %
TmP:     27.8     °C
    
```

Menu 6

Note that these are readings, rather than settings, and cannot be edited (note the empty arrow).

VPA	Voltage supplied to amplifier module.
IPA	Current absorbed to amplifier module.
Eff	Efficiency based on ratio of forward power to amplifier module power in percent (FWD PWR/(Vpa x Ipa) %).
Tmp	Machine internal temperature.

5.4.4 Alarm Menu (Alm)

This menu shows any alarm conditions occurring during machine operation. Alarm thresholds are preset at the factory.

```

▶ FWD:      0(10)
  RFL:      0(10)
  INP:      0(10)
  Reset Alm
    
```

Menu 7

FWD	Counter of alarm conditions triggered by forward power.
RFL	Counter of alarm conditions triggered by reflected power.
INP	Counter of alarm conditions triggered by input power.
Reset Alm	Alarm counter reset.

Alarm conditions are numbered from 1 to 10 and reflect the following situations: forward output power too high, reflected output power too high and input power too high.

Alarm monitoring cycle is as follows: when an alarm condition is detected, alarm counter increases by 1 unit, machine goes into lock-out state and the display shows the cause for the stop (chap. 5.3.4.1). After 15 seconds, the machine attempts to re-start; if a new alarm condition is detected, cycle is repeated over and over again up to 10 times maximum.

If machine re-starts successfully, all alarm counters are reset after 30 minutes' regular operation. After 10 alarm conditions triggered by the same cause, the machine goes into fault lock-out mode, a lock-out mode warning appears on the display and the "FAULT/LOCK" LED turns on (chap. 6.1 - [2]).

After the alarm condition has been rectified, the counter can be reset by highlighting "Reset Alm" and holding down the **ENTER** key for some time (chap. 6.1 - [9]).

5.4.4.1 Alarms and Faults

There are three types of alarms that can cause a machine lock-out and trigger a “FAULT/LOCK” indication. **When any one of the three alarm thresholds is exceeded, the system will automatically switch to the warning screen (even though the user is browsing system menus) and the following messages are displayed:**

1. Over Forward Power

Forward power threshold exceeded.



```
!! ATTENTION !!  
OVER FWD Power
```

Alarm 1

2. Over Reflected Power

Reflected power threshold exceeded.



```
!! ATTENTION !!  
OVER RFL Power
```

Alarm 2

3. Over Input Power

Input power threshold exceeded.



```
!! ATTENTION !!  
OVER INP Power
```

Alarm 3

Monitoring cycle is as follows:

- An alarm condition occurs;
- Alarm is displayed and device is locked out for 15 sec.;
- Operating conditions are restored;
- Verification.

Upon reaching the 10 cycle limit, a “FAULT/LOCK” indication is triggered and the device goes into lock-out mode; the appropriate LED turns on (figure 6.1 - [2]) and this screen is displayed:

I. Over Forward Power

Forward power alarm display.

```
!! HALTED FOR !!  
OVER FWD Power
```

Stop 1

II. Over Reflected Power

Reflected power alarm display.

```
!! HALTED FOR !!  
OVER RFL Power
```

Stop 2

III. Over Input Power

Input power alarm display.

```
!! HALTED FOR !!  
OVER INP Power
```

Stop 3

Once the machine goes into “FAULT/LOCK” mode, it will no longer attempt to re-start; choose the appropriate reset procedure according to current machine setting:

- Machine set to LOCAL control mode - press “Reset Alm” in the alarm menu (menu 7) or power off and back on again using the POWER switch (chap. 6.2 - item [11]).
- Machine set to REMOTE control mode - power off and back on again sending the appropriate command via the DB15 connector (chap. 6.3.3 - item [14] and [15]).

There is a fourth alarm that does not trigger a “FAULT/LOCK” condition, but allows some time until correct operating conditions are restored. When the temperature alarm threshold is exceeded (about 85°C), the following screen appears:

4. Over Temperature

Temperature power threshold exceeded.

```
!! ATTENTION !!  
OVER TEMPERATURE
```

Alarm 4

5.4.5 Miscellaneous Menu (Mix)

This menu lets you set machine address in an I²C bus serial connection:

```
▶ IIC:      255
```

Menu 8

IIC I²C address setting. The I²C network address becomes significant when the exciter is connected in an RVR transmission system that uses this protocol. Do not change it unless strictly required.

5.4.6 Version Menu (Vrs)

This screen holds machine version/release information:

```
▶ Rel:FPRO-000304  
Dat:02/03/2005  
Tab:PJL_01KL_01
```

Menu 9

Note that these are readings, rather than settings, and cannot be edited (note the empty arrow).

Rel	Firmware release information.
Dat	Release date.
Tab	Shows table loaded in the memory.

6. Front and Rear Panel Description

This section describes the components found on the front and rear panel of PJ1000-LIGHT.

6.1 Front Panel

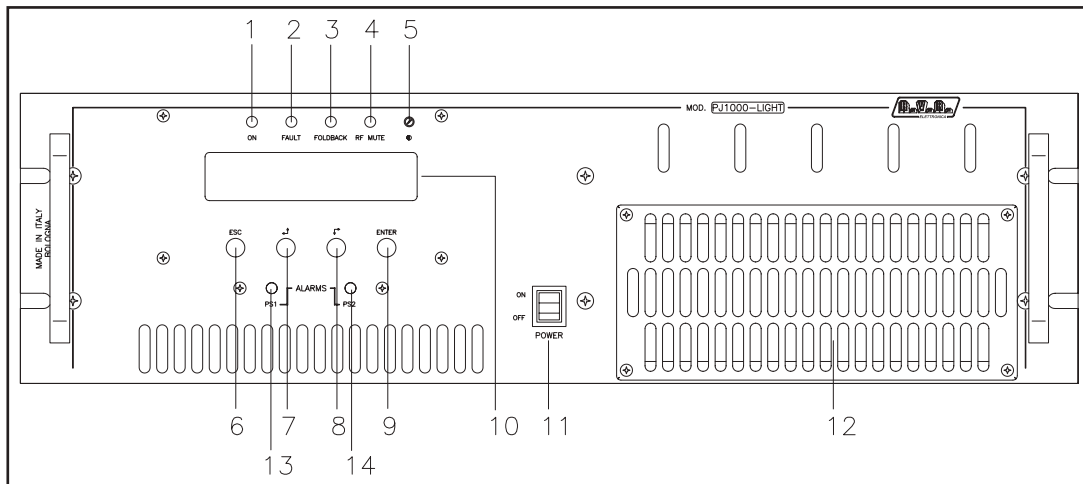



Figure 6.1

- | | |
|---|---|
| [1] ON | Green LED - Turns on when amplifier is powered on. |
| [2] FAULT/LOCK | Red LED - Turns on when machine is in permanent fault lock-out mode. |
| [3] FOLDBACK | Yellow LED - Turns on when foldback current limiting (Automatic Gain Control) is intervened. |
| [4] R.F. MUTE | Yellow LED - Turns on when exciter power output is inhibited by an external interlock signal. |
| [5] CONTRAST | Display contrast trimmer. |
| [6] ESC | Press this button to exit a menu. |
| [7]  | Navigation button used to browse menu system and edit parameters. |
| [8]  | Navigation button used to browse menu system and edit parameters. |
| [9] ENTER | Press this button to confirm a modified parameter and open a menu. |
| [10] DISPLAY | Liquid Crystal Display |
| [11] POWER | AC mains ON/OFF switch. |
| [12] AIR FLOW | Air grille. |
| [13] ALARMS PS1 | Yellow LED - Turns on when Power Supply unit is not fed either because "PWR OFF" was selected via software, or power is set to 0 W, or due to Power Supply malfunction (when this LED turns on, it causes the ALARM PS2 LED to come on as well, because the two LEDs are connected internally). |
| [14] ALARMS PS2 | Yellow LED, see item [13] |

6.2 Rear Panel

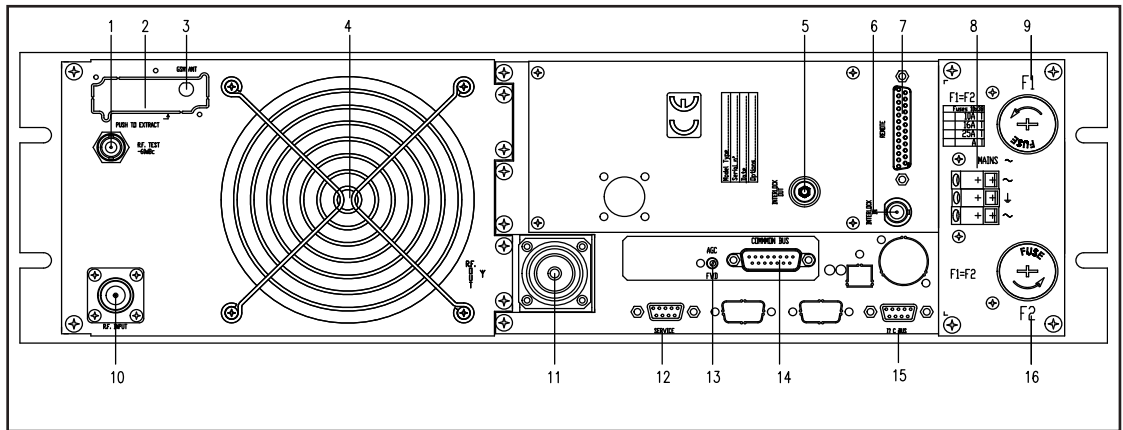

Figure 6.2

[1] R.F. TEST	Output with level -60 dB lower than output power level, suitable for modulation monitoring. Not suitable for spectrum analysis.
[2] GSM SLOT-IN	Reserved for future implementations
[3] GSM ANT	Reserved for future implementations
[4] AIR FLOW	Air grille.
[5] INTERLOCK OUT	Interlock output BNC connector: when the transmitter goes into stand-by mode, the (normally floating) central connector is connected to ground.
[6] INTERLOCK IN	Interlock input BNC connector: when central conductor is connected to ground, the transmitter is placed into forced standby mode.
[7] REMOTE	Telemetry DB25 connector.
[8] MAINS	Terminal board for 115-230 V 50-60 Hz mains power supply.
[9] FUSE 1	Mains power supply fuse (FUS10X38RP25).
[10] R.F. INPUT	"N"-type RF input connector.
[11] R.F. OUTPUT	7/8" RF output connector (7/16" connector available on request).
[12] SERVICE	DB9 connector for factory setting
[13] FWD EXT. AGC	Trimmer to set output power limitation according to FWD fold input.
[14] COM BUS	DB15 connector for interconnection with other devices.
[15] I ² C BUS	DB9 connector for communication in I ² C standard .
[16] FUSE 2	Mains power supply fuse (FUS10X38RP25).

6.3 Connectors description

6.3.1 Service (for factory setting purposes only)

Type: Female DB9

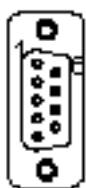

- 1 NC
- 2 TX_D
- 3 RX_D
- 4 Internally connected to 6
- 5 GND
- 6 Internally connected to 4

- 7 Internally connected to 8
- 8 Internally connected to 7
- 9 NC

6.3.2 Left (MONO) / Right Type: Female XLR



- 1 GND
- 2 Positive
- 3 Negative

6.3.3 I²C Bus Type: Male DB9

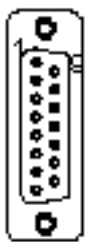

- 1 NC
- 2 SDA Serial DAta
- 3 SCL Serial CLock
- 4 NC
- 5 GND GND
- 6 NC
- 7 NC
- 8 NC
- 9 NC

6.3.4 COM BUS Type: Male DB15

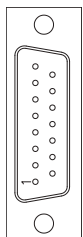

- 1 GND
- 2 NC
- 3 NC
- 4 NC
- 5 PWR REG
- 6 NC
- 7 NC
- 8 NC
- 9 NC
- 10 NC
- 11 NC
- 12 NC
- 13 NC
- 14 NC
- 15 NC

6.3.5 Remote

Type: Female DB25

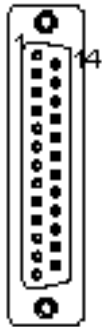

1	NC	
2	RF power amplifier voltage	3,9V x 40V
3	GND	GND
4	Reflected Power	3.9V x 50W
5	Interlock Out	Signals the activation by grounding the contact normally open
6	NC	
7	GND	GND
8	“On” Command	A pulse to ground (500 ms) delivers power output
9	Set 1 (FWD Power Good 1)	
10	WAIT	Signals the activation by grounding the contact normally open
11	Reset alarm	
12	OFF	A pulse to ground (500 ms) indicates the inhibit of power output
13	Interlock	Signals the activation by grounding the contact normally open
14	NC	
15	RF power amplifier current	3.9V x 34 A
16	Forward Power	3.9V x 1000W
17	FAULT	Signals the activation by grounding the contact normally open
18	Set 3 (RFL Power Good 3)	
19	NC	
20	“OFF” Command	A pulse to ground (500 ms) inhibits power output
21	GND	GND
22	Set 2 (FWD Power Good 2)	
23	LOC	Signals the activation by grounding the contact normally open
24	+Vcc	
25	ON	A pulse to ground (500 ms) indicates the deliver of power output

7. Technical Specifications

7.1 Mechanical characteristics

Panel Size	483 mm (19") x 132.5 mm (3 HE)
Depth	550 mm
Weight	approx. 31 Kg
Working Temperature	-10 °C ÷ 50 °C, without condensing

7.2 Electrical characteristics

General

RF output power	0-1000 W adjustable with continuity
Nominal driving power	11 W
Maximum driving power	17W typical (over 20W the machine goes on protection)
Frequency Range	87.5 - 108.0 MHz
Display	LCD alphanumeric (2 rows x 16 charcaters)
System control	4 push buttons
Signal Device	4 LED
RF module efficiency	71 % (76 % with equipment on input compression 18W)
Overall efficiency	61 % (68 % with equipment on input compression 18W)
A.C. supply	230 - 115 Vac ±15%
Power supply type	Monophase
Power factor	> 0.98
AC Apparent Power Consumption	1650 VA (1480 VA with equipment on input compression 18W)
Active Power Consumption	1630 W(1460 VA with equipment on input compression 18W)
Spurious & harmonic suppression	Meets or exceeds all FCC, CCIR and ETSI rules < 75 dBc (80 dBc typical)

Inputs

RF Input	N-type connecotr
RF input impedance	50 Ohm

Output

RF output	7/8" flange type connector (7/16" on demand)
Rf output impedance	50 Ohm
RF Test	BNC connector
output impedamce	50 Ohm
Output level	-60 dB referred to the RF output

Remote Connections

Interlock IN	BNC type female: by grounding the central conductor the transmitter is forced to stand-by mode. ponendo a massa il conduttore centrale il trasmettitore viene forzato in modo stand-by
Interlock OUT	BNC type female: in case the transmitter goes on stand-by mode, the central conductor, normally floated, comes grounding quando il trasmettitore entra in modalità stand-by, il conduttore centrale, normalmente flottante, viene posto a massa
Service	DB9 female, reserved to the firmware programming
I ² Cbus	DB9 female, I ² C communication bus for optional telemetry
Remote Interface	DB15 female, IIC + 4 analogic output for the measuring of parameters, 2 analogic input for the limitation of foldback power, 3 digital input for the management of the protection and switch on/ switch off

Options

/7-16	Optional output connector, 7/16" flange type, with impedance value of 50 Ohm
-------	--

7.3 Spare Parts

Subset for the Maintenance

Bias Board	SLBIAS1K3U-2
Low Pass Filter Board	SLLPFTEX1KL
Pass-through Filter Board	SLFILPJ1KM
Filter Board	SLFILPSPJ1KC
Panel Board	SL007PC2001B
Power Factor Correction	PFCPSL1000
50V 34A Power Supply	PSL5034
Pulse Protection Board	SLSRGPRPJ1KM
Input Power Measure Board	SLMIPPJ1KC
Splitter Board	SLSPLTEX1KL1
RF Module	SL010RF2001
Combiner Board	SLCMBTEX1KL1
Fuse Board	SLFURFPJ1KLG
Telemetry Board	SLTLMTXLCD03
Interface Board	SL010IN3001
PS LED Board	SLLDPSTEX1K

Use Parts

Frontal cooling fan	VTL4184
Rear cooling fan	9GL1224J102
Transformer	TRFTEX1000T
"SERVICE" Fuse	FUS5X20RP2
"1" e "2" Fuse	FUS10X38RP25

8. Operating principles

Figure 8.1 below provides an overview of PJ1000-LIGHT modules and connections.

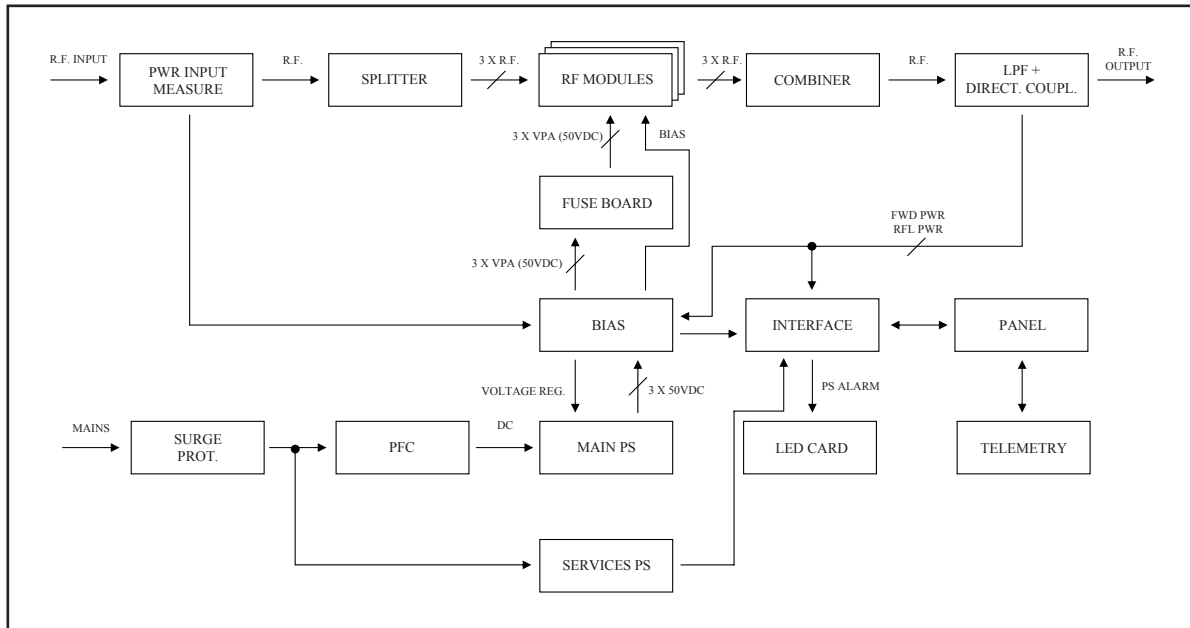

Figure 8.1

Following is a brief description of the different module functions; all diagrams and board layout diagrams are included in the “Technical Schedule” Vol.2.

8.1 Power supply

The PJ1000-LIGHT power supply section is made up of a surge protection module and two power supply units:

1. **Surge Protection module** (see description in chap. 8.1.1): protects the machine from possible voltage surge events and electric discharges in the power mains.
2. **Power amplifier supply unit:** provides adequate power supply for RF power amplifier modules. It is a switching power supply unit with PFC full range; for details of the PFC and converter modules, please see chapters 8.1.2 and 8.1.3, respectively.
3. **Service power supply unit:** provides adequate power supply for all modules except RF power modules. Major components of this 50-Hz transformer-based power supply unit are:
 - Power switch
 - Service fuse
 - Mains voltage selector
 - Service transformer



NOTE: Please see chapter 5.2 for power supply unit settings.

8.1.1 Mains power supply pulse protection (SLSRGPRPJ1KM)

This module is enclosed in a sealed metal case (see figure 9.1 - item [8]); it features two externally mounted mains fuses (figure 6.2 - [7] and [20]) and accommodates a bank of surge arresters that protect the machine from any surge events in the power mains.

Mains voltage is brought from this module to the main Power switch on the front panel (figure 6.1 - [11]), which relays it to the service transformer TR1 (figure 9.2 - [4]).

Inside the surge protection module, a suitable 24VDC relay controlled via the interface board isolates (single line) mains voltage to be fed to the power amplifier power supply unit (PFC module). This way, mains power supply to PFC is enabled when these requirements are met:

- POWER switch on front panel (figure 6.1 - [11]) set to ON;
- No alarm or fault events present (see chapter 5.3.4);
- Power output enabled (set to ON) in FNC operation menu (menu 4, see chapter 5.3.1);
- RF output power set to over 0W using the edit mode (menu 2, see chapter 5.2).

8.1.2 PFC unit (PFCPSL1000)

The PFC unit is a rectifier that modulates absorbed current to ensure that the wave is sinusoidal as much as possible and achieve a 99% power factor.

The PFC unit can operate on 115 VAC or 230 VAC input voltage. It features a voltage selection block that normally does not require setting: see chapter 5.1.2 for a detailed description.

8.1.3 Switching power supply (PSL5034)

The switching power supply incorporated in the amplifier feeds 50 VDC to the RF power modules with 34 A maximum current.

This module has a control input that enables output voltage reduction when needed (for instance, in the event of RF output power reduction). Another input signal is used to shut down the power supply (0V output voltage) when any one of the following conditions is verified:

- Power output disabled (set to OFF) by user in FNC operation menu (menu 4, see chapter 5.3.1);

- Regulated power set to 0 Watt using the edit mode (menu 2, see chapter 5.2);
- An alarm or fault condition has occurred (see chapter 5.3.4).

8.2 Interface board (SL010IN3001)

This board performs the following tasks:

- It uses AC voltage from transformer TR1 to generate and distribute service power supply over the panel board;
- It controls and provides interfacing of the mains surge protection module (SLSRGPRPJ1KM);
- It controls and provides interfacing of the power amplifier power supply module (PSL5034);
- It processes and provides interfacing of the control signals to/from the Bias Board (SLBIAS1K3U-2);
- It processes and provides interfacing of the control signals to/from the Panel Board (SL007PC2001B);
- It acquires and processes the input signals from the input power measurement board (SLMPIPPJ1KC);
- It feeds and operates the cooling fans;
- It feeds and controls the LED indicator board.

8.3 Panel board - CPU (SL007PC2001B)

The panel board accommodates the microcontroller that runs the machine control software and all user interface elements (display, LED's, keys, ...).

This board is interfaced with other machine modules via *flat cables* and provides for power supply, control signals and measurement distribution.

8.4 PWR Input Measure Board

This board enables measurement of the following parameters:

- Input power measurement;
- Main heat sink temperature measurement by an LM 50 sensor mounted on the board; it obtain the temperature through a fixing screw.

Both measurements are adequately processed and sent to the interface board that controls the protection modules and relays the signals to the CPU board to enable readings to be displayed.

8.5 Power amplifier

The RF power amplification section consists in three power modules coupled through a Wilkinson splitter and combiner using strip-line technology.

Each RF module (code SL010RF2001) provides 350 W rated power using a single active element built using MOS technology. RF modules are fed by the switching power supply via the Bias board.

The splitter (Splitter Board code SLSPLTEX1KL1) splits power input signal supplied to machine equally to the three RF modules. The combiner (Combiner Board code SLCMBTEX1KL1) combines the power output signals at module outputs to obtain total amplifier power.

Splitter, amplifiers and combiner have been designed to sum amplifier output power signals in phase, so as to keep unbalance and power dissipation to a minimum.

The whole RF section is mounted on a cooling fin that ensure the cooling of the machine through forced ventilation.

8.6 LPF Board (SLLPFTEX1KL)

This board incorporates a low-pass filter to keep amplifier harmonics within permissible limits as specified by international standards.

A directional coupler is provided at filter output to measure forward and reflected RF output power; power readings are relayed to the Interface and Bias boards to enable processing and display.

The LPF board incorporates an RF output (having a level about -60 dB lower than output level) which is brought to a BNC connector (figure 6.2 - [1]). This provides a convenient test point to check carrier characteristics, **but does not ensure an accurate assessment of higher harmonics.**

8.7 BIAS board (SLBIAS1K3U-2)

The main purpose of this board is to control and correct the bias voltage of the RF amplification section MOSFETs.

It also provides a measure of the total current absorbed by the RF modules and incorporates a dedicated circuit for power supply fault reporting.

Under normal conditions, bias voltage is adjusted according to set output power using feedback based on actual output power reading (AGC).

Abnormal conditions affecting bias voltage so as to trigger foldback current limiting are:

- Exceeding reflected power at output
- External AGC signals (Ext. AGC FWD, Ext. AGC RFL)
- Temperature too high
- Any one RF module drawing too much current.

8.8 External Telemetry Interface Board (SLTLMTXLCD03)

This board provides an I/O interface for the CPU with the outside environment. All available machine input and output signals are brought to the REMOTE DB15 connector (chap. 6.3.4).

Also mounted on this board is the INTERLOCK IN BNC connector (figure 6.2 - [12]) which can disable device power output. When the central pin is closed to ground, output power is limited to zero until ground connection is removed.

The INTERLOCK OUT BNC connector (figure 6.2 - [10]), when used in combination with an R.V.R. amplifier, is connected to the exciter REMOTE or INTERLOCK IN connectors using a BNC-BNC connector. In the event of an amplifier fault, the central conductor is connected to ground and the transmitter is placed into forced standby mode.

9. Identification and Access to the Modules

The **PJ1000-LIGHT** is made up of various modules linked to each other through connectors so as to make maintenance and any required module replacement easier.

9.1 Top View

The figure below shows the equipment top view with the various components pointed out.

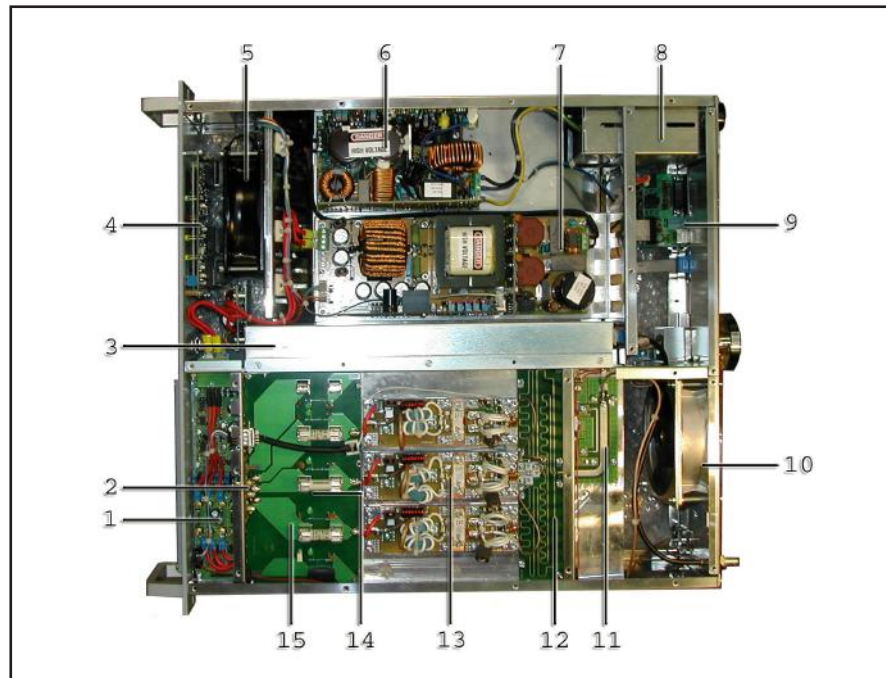

Figure 9.1

- [1] Bias Board (SLBIAS1K3U-2)
- [2] Pass-through Filter Board (SLFILPJ1KM)
- [3] Low Pass Filter Board (SLLPFTEX1KL)
- [4] Panel Board (SL007PC2001B)
- [5] FAN1 Cooling Fan (VTL4184)
- [6] Power Factor Correction Board (PFCPSL1000)
- [7] 50V 34A Power Supply (PSL5034)
- [8] Pulse Protection Board (SLSRGPRPJ1KM)
- [9] Telemetry Board (SLTLMTXLCD03)
- [10] FAN2 Cooling Fan (9GL1224J102)
- [11] Input Power Measure Board (SLMPIPPJ1KC)
- [12] Splitter Board (SLSPLTEX1KL1)
- [13] RF module (SL010RF2001)
- [14] Combiner Board (SLCMBTEX1KL1)
- [15] Fuse Board (SLFURFPJ1KLG)

9.2 Bottom View

The figure 9.2 shows the equipment bottom view with the various components pointed out.

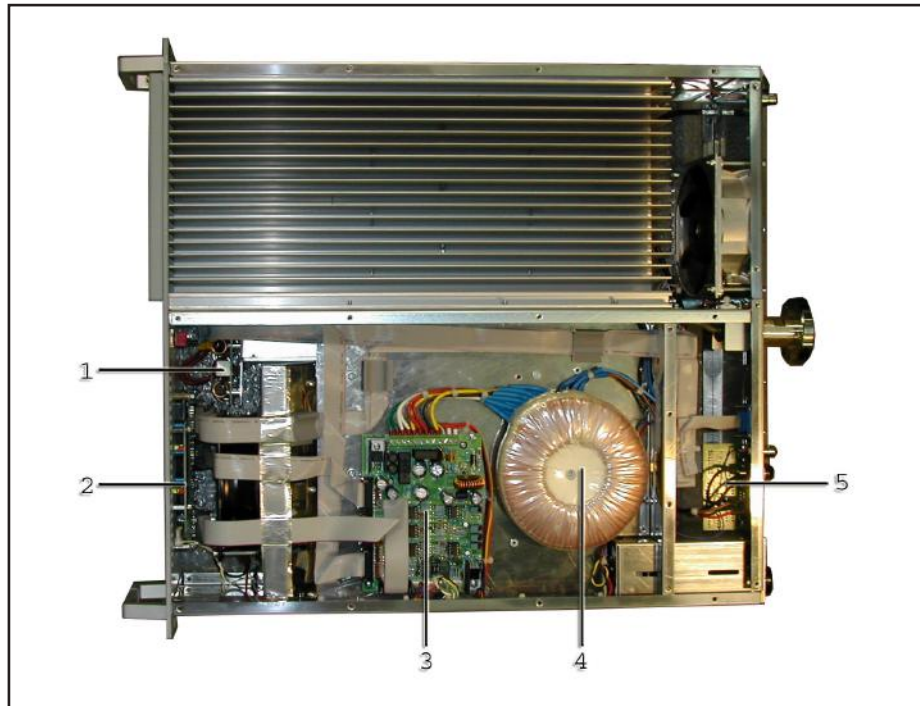

Figure 9.2

- [1] Filter Board (SLFILPSPJ1KC)
- [2] PS LED Board (SLLEDPSTEX1K)
- [3] Interface Board (SL010IN3001)
- [4] TR1 Transformer (TRFTEX1000T)
- [5] Telemetry Board (SLTLMTXLCD03)