

---

---

# PJ2000M-C, PJ2500M-C & PJ3000M-C

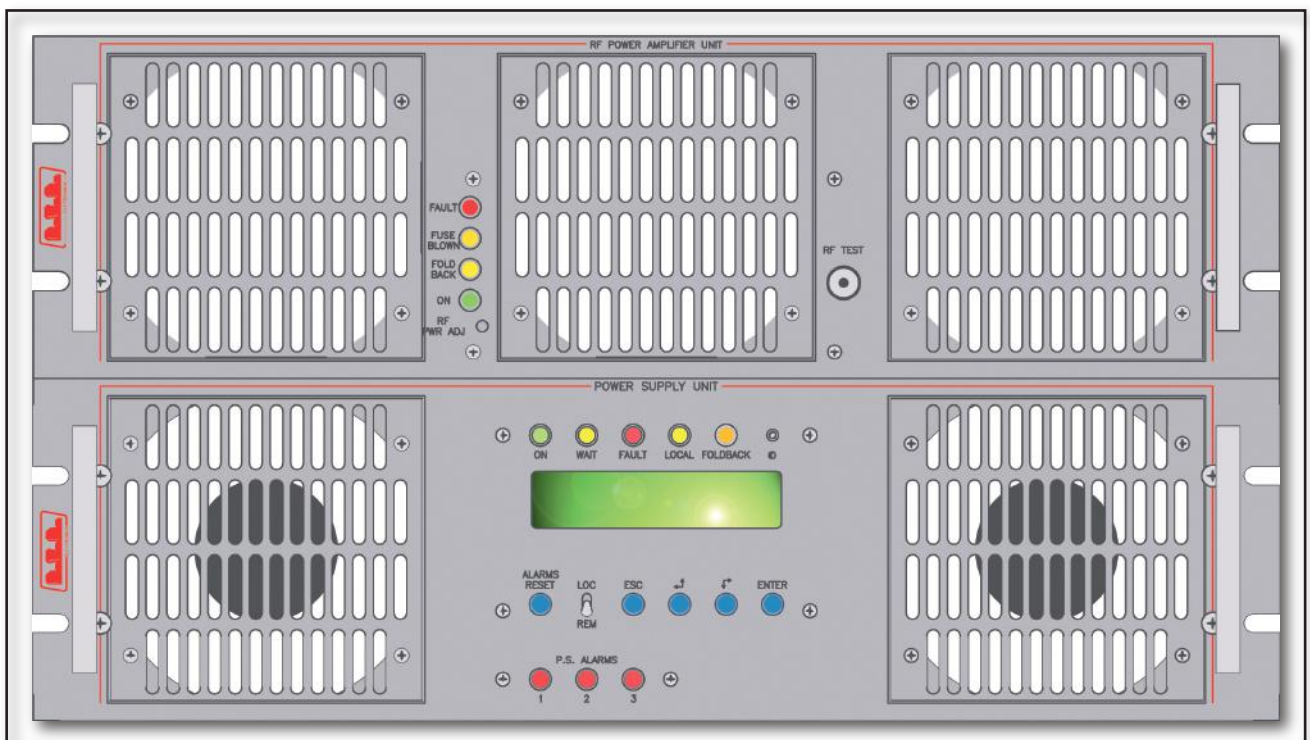

## User Manual Volume 1

---

---

Manufactured by



Italy



**File Name:** PJ2000M-C\_PJ2500M-C&PJ3000M-C\_ING\_1.5.indb

**Version:** 1.5

**Date:** 09/01/2009

### Revision History

Date	Version	Reason	Editor
28/01/2003	1.0	First Version	D. Canazza
15/07/2003	1.1	Description part Upgrade	J. H. Berti
15/07/2005	1.2	Mod. PJ2500M-C integration	J. H. Berti
29/11/2006	1.3	Mod. PJ3000M-C Integration	J. H. Berti
08/10/2007	1.4	PS Input Voltage and technical Specifications Upgrade	J. H. Berti
09/01/2009	1.5	Monophase and three-phase wiring upgrade	J. H. Berti

PJ2000M-C, PJ2500M-C & PJ3000M-C - User Manual  
Version 1.5

© Copyright 2003-2009

R.V.R. Elettronica SpA

Via del Fonditore 2/2c - 40138 - Bologna (Italia)

Telephone: +39 051 6010506

Fax: +39 051 6011104

Email: info@rvr.it

Web: www.rvr.it

All rights reserved

Printed and bound in Italy. No part of this manual may be reproduced, memorized or transmitted in any form or by any means, electronic or mechanic, including photocopying, recording or by any information storage and retrieval system, without written permission of the copyright owner.

#### **Notification of intended purpose and limitations of product use**

This product is a FM transmitter intended for FM audio broadcasting. It utilises operating frequencies not harmonised in the intended countries of use.

The user must obtain a license before using the product in intended country of use. Ensure respective country licensing requirements are complied with.

Limitations of use can apply in respect of operating frequency, transmitter power and/or channel spacing.

#### **Declaration of Conformity**

Hereby, R.V.R. Elettronica SpA, declares that this FM transmitter is in compliance with the essential requirements and other relevant provisions of Directive 1999/5/EC.



# Table of Contents

<b>1.</b>	<b>Preliminary Instructions</b>	<b>1</b>
<b>2.</b>	<b>Warranty</b>	<b>1</b>
<b>3.</b>	<b>First Aid</b>	<b>2</b>
3.1	Treatment of electrical shocks	2
3.2	Treatment of electrical Burns	2
<b>4.</b>	<b>General Description</b>	<b>3</b>
4.1	Make-up	3
<b>5.</b>	<b>Quick installation and operating reference</b>	<b>5</b>
5.1	Preparation	5
5.2	Operation	8
5.3	Software	9
5.4	Protection System	15
<b>6.</b>	<b>External Description</b>	<b>17</b>
6.1	PS Module Frontal Panel	17
6.2	PS module Rear Panel	18
6.3	Connector Description	19
6.4	RF Module Frontal Panel	22
6.5	RF module Rear Panel	23
<b>7.</b>		<b>25</b>
<b>8.</b>	<b>Operating Theory</b>	<b>28</b>
8.1	Power Supply Change	31
8.2	PS Part	35
8.3	RF Part	37
<b>9.</b>	<b>“Low-Drive Power” Option (/LD)</b>	<b>39</b>
9.1	“Low-Drive power” Board	39



*This page was intentionally left blank*

## IMPORTANT



The symbol of lightning inside a triangle placed on the product, evidences the operations for which is necessary gave it full attention to avoid risk of electric shocks.



The symbol of exclamation mark inside a triangle placed on the product, informs the user about the presence of instructions inside the manual that accompanies the equipment, important for the efficacy and the maintenance (repairs).

## 1. Preliminary Instructions

### • General foreword

The equipment in object is to considering for uses, installation and maintenance from "trained" or "qualified" staff, they conscious of the risks connected to operate on electronic and electrical circuits electrical.

The "trained" definition means staff with technical knowledge about the use of the equipment and with responsibility regarding the own safety and the other not qualified staff safety place under his directed surveillance in case of works on the equipment.

The "qualified" definition means staff with instruction and experience about the use of the equipment and with responsibility regarding the own safety and the other not qualified staff safety place under his directed surveillance in case of works on the equipment.

**⚡ WARNING: The machine can be equipped with an ON/OFF switch which could not remove completely voltages inside the machine. It is necessary to have disconnected the feeding cord, or to have switched off the control panel, before to execute technical operations, making sure himself that the safety connection to ground is connected.**

**The technical interventions that expect the equipment inspection with circuits under voltage must be carry out from trained and qualified staff in presence of a second trained person that it is ready to intervene removing voltage in case of need.**

R.V.R. Elettronica SpA doesn't assume responsibility for injury or damage resulting from improper procedures or practices by untrained/unqualified personnel in the handling of this unit.

**⚡ WARNING: The equipment is not water resistant and an infiltration could seriously compromise its correct operation. In order to prevent fires or electric shocks, do not expose the equipment to rain, infiltrations or humidity.**

Please observe all local codes and fire protection standards during installation and use of this unit.

**⚡ WARNING: The equipment has to its inside exposed parts to risk of electric shock, always disconnect power before opening covers or removing any part of this unit.**

Fissures and holes are supplied for the ventilation in order to assure a reliable efficacy of the product that for protect itself from excessive heating, these fissures do not have to be obstructed or to be covered. The fissures doesn't be obstructed in no case. The product must not be incorporated in a rack, unless it is supplied with a suitable ventilation or that the manufacturer's instructions are been followed.

**⚠ WARNING: This equipment can irradiate radio frequency energy and if it's not installed following the instructions contained in the manual and local regulations it could generate interferences in radio communications.**

**⚠ WIRING: This device has a connection to ground on the power cord and on the chassis. Check that they are correctly connected.**

Operate with this device in a residential ambient can cause radio disturbs; in this case, it can be demanded to the user to take adequate measures.

Specifications and informations contained in this manual are furnished for information only, and are subject to change at any time without notice, and should not be construed as a commitment by R.V.R. Elettronica SpA.

The R.V.R. Elettronica SpA assumes no responsibility or liability for any errors or inaccuracies that may appear in this manual, including the products and software described in it; and it reserves the right to modify the design and/or the technical specifications of the product and this manual without notice.

**• Warning regarding the use designated and the use limitations of the product.**

This product is an transmitter radio indicated for the audio broadcasting service in frequency modulation. It uses working frequencies that are not harmonized in the states of designated user.

The user of this product must obtain from the Authority for spectrum management in the state of designated user the appropriate authorization to use the radio spectrum, before putting in exercise this equipment.

The working frequency, the transmitter power, let alone other specifications of the transmission system are subject to limitation and defined in the authorization obtained.

## 2. Warranty

R.V.R. Electronics S.P.A. guarantees absence of manufacturing defect and the good operation for the products, within the provided terms and conditions.

Please read the terms carefully, because the purchase of the product or acceptance of order confirmation, constitutes acceptance of the terms and conditions.

For the last legal terms and conditions, please visit our web site ([WWW.RVR.IT](http://WWW.RVR.IT)) wich may also be changed, removed or updated for any reason without prior notice.

Warranty will be void in cases of opened products, physical damage, misuse, modification, repair by unauthorised persons, carelessness and using the product for other purpose than its intended use.

In case of defect, proceed like described in the following:

- 1 Contact the dealer or distributor where you purchased the unit. Describe the problem and, so that a possible easy solution can be detected.

Dealers and Distributors are supplied with all the information about problems that may occur and usually they can repair the unit quicker than what the manufacturer could do. Very often installing errors are discovered by dealers.

- 2 If your dealer cannot help you, contact R.V.R. Elettronica and explain the problem. If it is decided to return the unit to the factory, R.V.R. Elettronica will mail you a regular authorization with all the necessary instructions to send back the goods;

- 3 When you receive the authorization, you can return the unit. Pack it carefully for the shipment, preferably using the original packing and seal the package perfectly. The customer always assumes the risks of loss (i.e.,

R.V.R. is never responsible for damage or loss, until the package reaches R.V.R. premises. For this reason, we suggest you to insure the goods for the whole value. Shipment must be effected C.I.F. (PREPAID) to the address specified by R.V.R.'s service manager on the authorization



**DO NOT RETURN UNITS WITHOUT OUR AUTHORIZATION AS THEY WILL BE REFUSED**

- 4 Be sure to enclose a written technical report where mention all the problems found and a copy of your original invoice establishing the starting date of the warranty.

Replacement and warranty parts may be ordered from the following address. Be sure to include the equipment model and serial number as well as part description and part number.



R.V.R. Elettronica SpA  
Via del Fonditore, 2/2c  
40138 BOLOGNA ITALY  
Tel. +39 051 6010506

## 3. First Aid

The personnel employed in the installation, use and maintenance of the device, shall be familiar with theory and practice of first aid.

### 3.1 Treatment of electrical shocks

#### 3.1.1 If the victim is not responsive

Follow the A-B-C's of basic life support.

- Place victim flat on his back on a hard surface.
- Open airway: lift up neck, push forehead back (**Figure 1**).

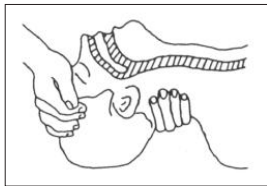

Figure 1

- clear out mouth if necessary and observe for breathing
- if not breathing, begin artificial breathing (**Figure 2**): tilt head, pinch nostrils, make airtight seal, four quick full breaths. Remember mouth to mouth resuscitation must be commenced as soon as possible.



Figure 2

- Check carotid pulse (**Figure 3**); if pulse is absent, begin artificial circulation (**Figure 4**) depressing sternum (**Figure 5**).

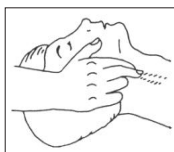

Figure 3



Figure 4

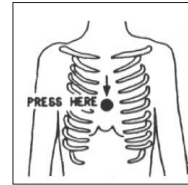

Figure 5

- In case of only one rescuer, 15 compressions alternated to two breaths.
- If there are two rescuers, the rythm shall be of one brath each 5 compressions.
- Do not interrupt the rythm of compressions when the second person is giving breath.
- Call for medical assistance as soon as possible.

#### 3.1.2 If victim is responsive

- Keep them warm.
- Keep them as quiet as possible.
- Loosen their clothing (a reclining position is recommended).
- Call for medical help as soon as possible.

### 3.2 Treatment of electrical Burns

#### 3.2.1 Extensive burned and broken skin

- Cover area with clean sheet or cloth.
- Do not break blisters, remove tissue, remove adhered particles of clothing, or apply any salve or ointment.
- Treat victim for shock as required.
- Arrange transportation to a hospital as quickly as possible.
- If arms or legs are affected keep them elevated.

If medical help will not be available within an hour and the victim is conscious and not vomiting, give him a weak solution of salt and soda: 1 level teaspoonful of salt and 1/2 level teaspoonful of baking soda to each quart of water (neither hot or cold).

Allow victim to sip slowly about 4 ounces (half a glass) over a period of 15 minutes.

Discontinue fluid if vomiting occurs.

DO NOT give alcohol.

#### 3.2.2 Less severe burns

- Apply cool (not ice cold) compresses using the cleansed available cloth article.
- Do not break blisters, remove tissue, remove adhered particles of clothing, or apply salve or ointment.
- Apply clean dry dressing if necessary.
- Treat victim for shock as required.
- Arrange transportation to a hospital as quickly as possible.
- If arms or legs are affected keep them elevated.

## 4. General Description

The **PJ3000M-C** is an RF amplifier for frequency modulation sound broadcasting with a max. rated output of 3000 watts, for the **PJ2500M-C** the max. rated output is 2500W while for the **PJ2000M-C** model the max. rated output is of 2000 watts. They are a fully solid-state apparatus of modern design that use MOSFET as active components in the FM amplifying modules. This chapter briefly describes the machine's main features.

### 4.1 Make-Up

The **PJ3000M-C**, **PJ2500M-C** and **PJ2000M-C** amplifiers are made up of two interconnected modules pre-arranged for assembly in a 19" rack.

The two modules are as follows:

- Control and power supply module (called **PS**)
- RF amplifier module (called **RF**)

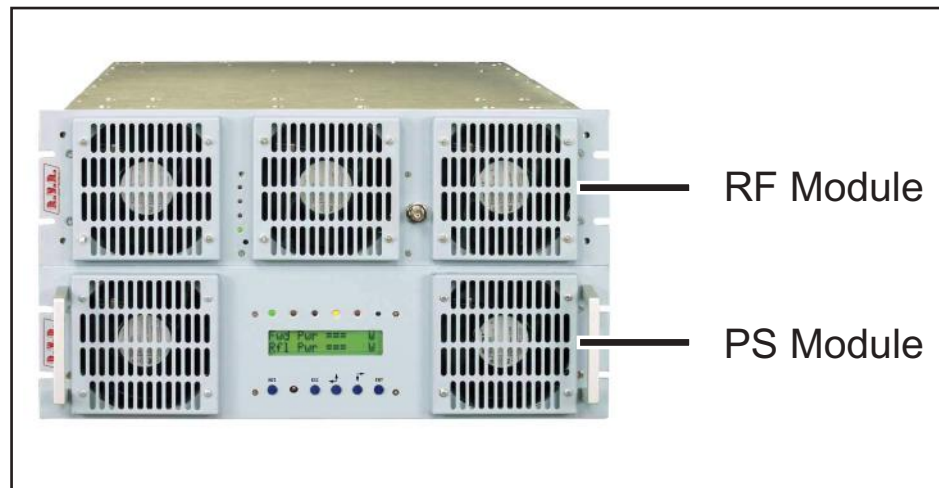

Figure 4-1: PJ3000M-C, PJ2500M-C and PJ2000M-C modules

Subdividing it into two modules not only makes it easier to handle and assemble the amplifier but also permits to perform maintenance to the two parts separately.

The **PJ3000M-C** houses six identical modules, based on the MOSFET BLF278 (2x) device, each supplies 550 watts; the **PJ2500M-C** and **PJ2000M-C** model houses eight modules, based respectively on the MOSFET SD2942 and BLF278 device, that supply 350 and 300 watts each, instead.

The amplifier is controlled by a microprocessor-based system that includes a LCD which carries out the following functions:

- Measuring and displaying amplifier work parameters
- Activating and deactivating power delivery
- Protecting the amplifier as far as potentially harmful situations are concerned such as excess supplied power, SWR, excessive pilot power or temperature

- Detecting the warning thresholds set by the user (e.g. power delivered below a specific threshold), which are made available to the user via the telemetry connector
- Communicating with external devices

The amplifier's control software is based on a menu system through which the user may navigate using the following four buttons: **ESC**, **←**, **↑**, **↓**, and **ENTER**. A fifth button is provided for resetting any triggered alarms.

The PS module of this amplifier houses three rectifier/power supply switching units that normally work in parallel mode and that provide a fair degree of redundancy to the machine. Even if one of the power supply modules breaks down the amplifier will keep working at reduced power.

A schematic view of the operating theory of amplifier is shown in the figure:

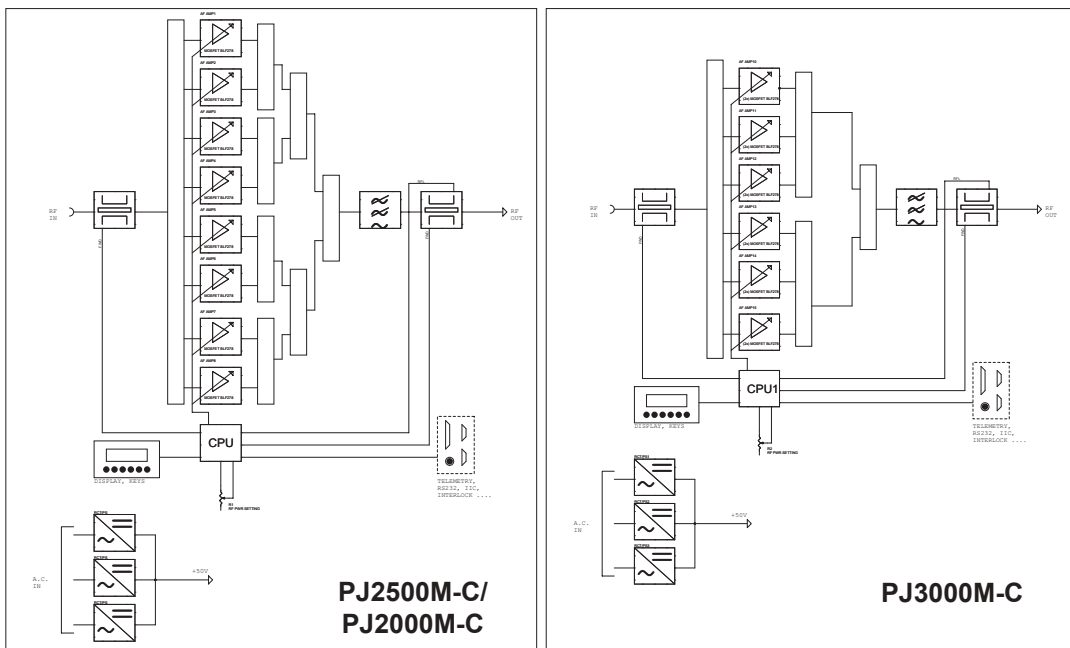

Figure 4-2: theory of operation



## 5. Quick installation and operating reference

The scope of this chapter is to summarize the procedures for installing the machine. If any point is not fully comprehensible, such as how to operate the machine the first time, it is advisable to read the entire manual very carefully.

In this description it is assumed that the amplifier is not supplied pre-installed in a rack inside a transmission system. In this case most of the operations outlined herein (for instance the wiring ones) are obviously not necessary.

### 5.1 Preparation

Unpack the amplifier and firstly check that it has not been damaged in any way during transport. Make sure that all the connectors and controls on the front and back panels are in good order.

Check the default setting of the type of power supply for this machine on the back of the **PS** module, which may be:

- single-phase 208 V, +15% -10%
- single-phase 230 V, +10% -15%
- three-phase 208 V, +15% -10%
- three-phase 230 V, +10% -15%
- three-phase 400 V, +10% -15%



**Suggestion:** Specify the type of power supply at order placement: the machine will be delivered to you configured according to your requirements.

Check, if need be, that the fuses are installed, in good working order and accessible on the back panel of the PS module. The required fuse values are as follows:

	@208/230V single phase	@208/230V three phase	@400V three phase
AUX OUT FUSE <i>(chap. 6.2 - position [9])</i>	(1x) F6,3T type 5x20	(1x) F6,3T type 5x20	(1x) F6,3T type 5x20
SERVICE FUSE <i>(chap. 6.2 - position [10])</i>	(1x) F6,3T type 5x20	(1x) F6,3T type 5x20	(1x) F6,3T type 5x20
MAINS FUSE PJ2500M-C e PJ2000M-C <i>(chap. 6.2 - position [1])</i>	(3x) F25T type 10x38	(3x) F20T type 10x38	(3x) F16T type 10x38
MAINS FUSE PJ3000M-C <i>(chap. 6.2 - position [1])</i>	(3x) F32T type 10x38	(3x) F25T type 10x38	(3x) F16T type 10x38

Install the amplifier in a standard rack for 19" modules.  
Assemble the modules by inserting them one on top of the other.

Make the connections between the **PS** module and the **RF** module using the cables supplied with the machine:

- Data connection by means of cable with DB37 connectors (PS-RF Interconnection)

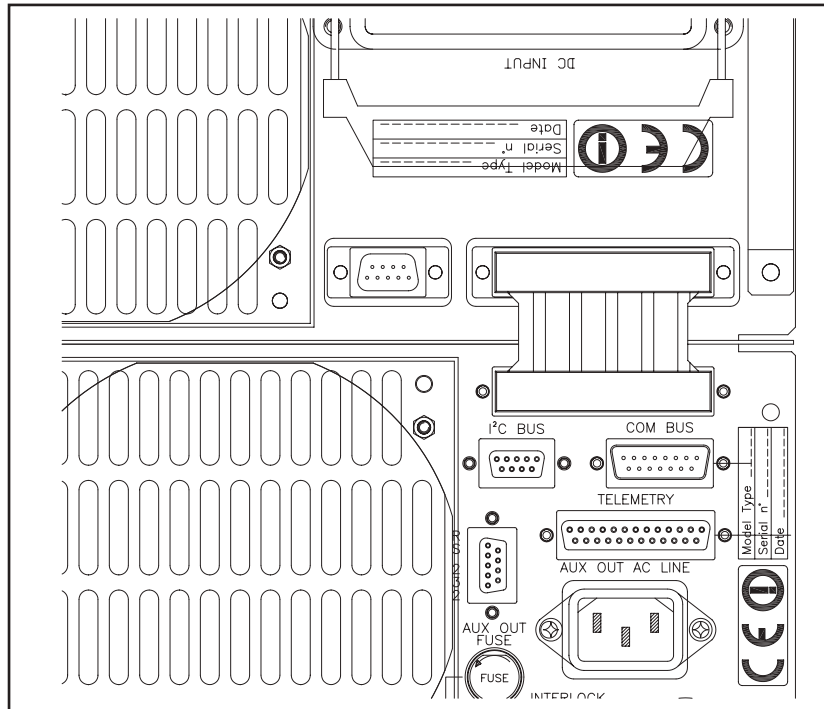

- Ground connection between each module chassis

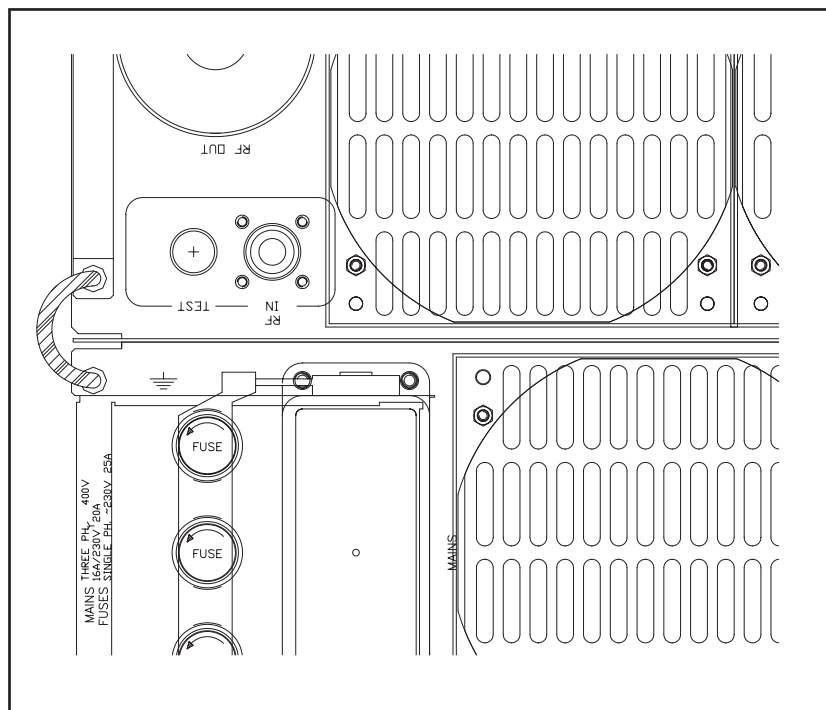

- Power supply connection by means of cable coming out of the **PS** module ending with the ILME CXM 4/2 type of socket (DC Output)



**Figure 5-1** Example of installation in a rack

Connect the output of a suitable type of FM exciter (e.g. the PTXLCD of R.V.R. Elettronica) to the RF input (**RF** module) using a cable fitted with N type connectors. The exciter should be set to minimum output power and OFF.

Connect the amplifier's INTERLOCK connector (on the back of the PS module) to the exciter's Interlock input, if available (it is available in all RVR Elettronica exciters) using a twin wire with BNC connectors.



**Note:** the amplifier's INTERLOCK connector is an output. The operating logic is as follows: the internal conductor floats when the amplifier works correctly, on the contrary power is delivered and the internal conductor is closed to ground to halt the exciter.

Connect the RF output to the antenna cable or to a dummy load capable of dissipating the power generated by the amplifier.

An ILME model CXF4/2 multipole socket is supplied with the amplifier to power the machine. The socket must be connected to the multipole cable that will be wired to the mains switchboard.



**Danger:** to avoid any risk of shock make **ABSOLUTELY** sure that the power supply cable is **NOT** powered when the multipole socket is connected to the cable itself.

Connect the multipole socket to the power supply cable as described below and refer to figure 5-2:

Three-phase power supply:

- G      Ground
- 1      Neutral
- 2      R Phase
- 3      S Phase
- 4      T Phase
- 11,12 Not connected

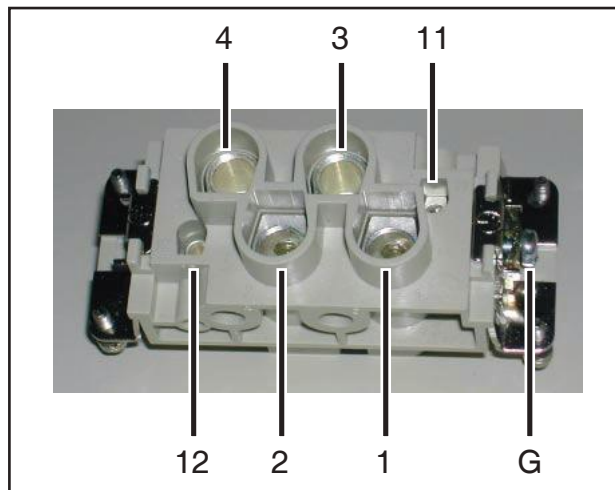

Figure 5-2: View of the mains multipole socket - terminals side (internal)

Single-phase power supply:

- G Ground
- 1 Not connected
- 2 Phase
- 3 Neutral
- 4 Not connected
- 11,12 Not connected



**Danger:** avoid the **risk of damaging the machine** by grounding it correctly. As such, connect the ground conductor of the power supply cable to the specific terminal in the multipole socket and check the efficiency of your own grounding system.

Check that the multi-turn RF PWR ADJ trimmer on the RF module is turned clockwise completely (as factory setting). As such, the action of the Automatic Gain Control (AGC) is disabled.

## 5.2 Operation

After having plugged in the power supply socket at the back of the machine, power on the amplifier via the switchboard. The ON LEDs on both modules will turn on and the forced cooling fans will start running. The LCD shows the first introductory screenful and then switches to a screenful that indicates the forward and reflected power values.

Turn on the exciter (at lowest power) and wait until it locks to the work frequency. Once locked, increase power gradually and check the amplifier's display. Increase the exciter's power until the amplifier's output attains the desired value, max. 3000 watts for **PJ3000M-C** model, or 2500 watts for **PJ2500M-C** model, or 2000 watts for **PJ2000M-C** model (keep in mind that due to the measurement digitalization

effect it might not be possible to obtain a reading of exactly 3 kW, 2.5 kW or 2 kW, but a lightly higher or lower value which is perfectly normal).



**Note:** now the amplifier is adjusted to its rated output, but **the AGC function is not checking the delivered power**. Any changes in the driving power or in the environmental conditions could cause slight output power changes.

In order to operate the AGC, increase the driving power by about 10% as compared to the value required to obtain the amplifier's desired output level (the amplifier's output power will increase but this is not a hazard for the amplifier thanks to its built-in protection system).

Now turn the multi-turn RF PWR ADJ trimmer on the RF module counterclockwise and check on the display that the power delivered by the amplifier decreases until the desired value is attained.

Should you need to use the amplifier at a power level lower than the rated one, proceed as follows:

- If back-off is temporary (for instance to run a test), reduce the output power level of the exciter until power delivered from the amplifier reaches the desired value.
- If back-off is permanent (to set the station's power at a level lower than the maximum rated output), first disable the AGC by turning the RF PWR ADJ trimmer clockwise all the way. Then reduce driving power until you attain an amplifier output power value equivalent to the desired level plus approximately 10 %. Finally turn the trimmer counterclockwise until the delivered power decreases to the required level.

Now all of the machine's operating parameters may be checked via the software control system.

As a rule, the machine does not need to be manned to work. If any alarm conditions occur, they will be managed automatically by the protection system or notified to the user by means of LEDs on the panel and messages on the display.

## 5.3 Software

This chapter describes the ways in which the microprocessor controls the amplifier and how the user may interact with the software.

Questo capitolo descrive le modalità con cui il microprocessore controlla l'amplificatore, e come l'utente può interagire con il software.

The figure in the follow shows the overall software user interface diagram.



**Note:** the user may issue commands to the equipment only when in LOCAL mode by means of the selector. Otherwise the user may only read the parameters and not change them.



Figura: Flow diagram of the software

When turned on, the LCD shows the introductory screenful with the equipment's software and hardware versions.

```

PJ3000M-C LCD
SW 2.01 HW 1.01
  
```

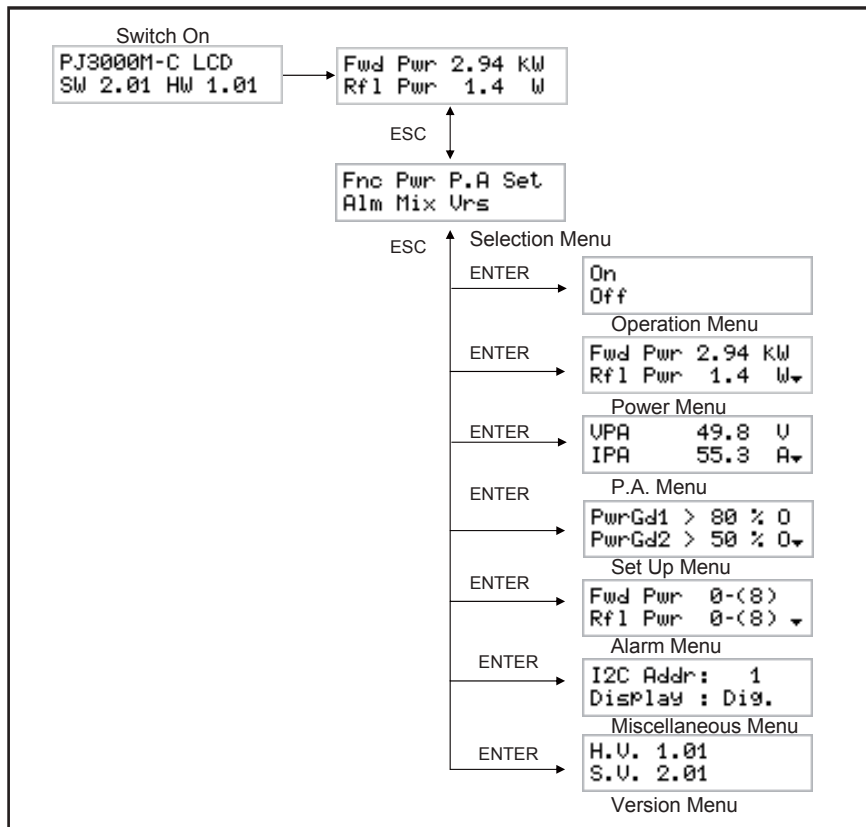
A few seconds later the main screenful is displayed indicating the forward and reflected power values:

```

Fwd Pwr 2.94 kW
Rfl Pwr 1.4 W
  
```

Press the ESC key to view the selection screenful from which to access all the menus:

```

Fnc Pwr P.A Set
Alm Mix Urs
  
```

To access one of the submenus select its name (which is underlined by a blinking cursor) using the RIGHT or LEFT keys and then press the ENTER key.

Take note that certain parameters, which are measured and shown to the user, might not be available in a few cases. This occurs when, for physical reasons, the measured values are not significant for control software internal use.

When the value of a parameter is not available for the aforesaid reason, symbol “==” appears on the display in lieu of the value.

### 5.3.1 Operating Menu (Fnc)

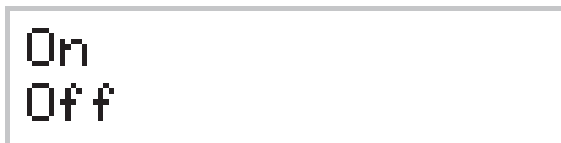

Turn the power amplifier ON or OFF via this menu.

When the amplifier is turned OFF, the internal conductor of the INTERLOCK connector is set to ground so as to force the connected exciter to a stand-by condition (this takes place only if the exciter features the interlock option, like those produced by RVR, and if the associated connector is connected to the amplifier).

When the amplifier is turned OFF the software program waits a few seconds for the machine to cool down and then the fans turn OFF.

### 5.3.2 Power Menu (Pwr)

This screen, made up of several lines that may be scrolled through using the UP and DOWN keys, displays all the measurements associated with the behaviour of the amplifier's power section:

- Forward Power (Fwd Pwr)
- Reflected Power (Rfl Pwr)
- SWR (Standing Wave Ratio)
- Input Power (Inp Pwr)
- Internal SWR (Int SWR)

Depending on the machine's configuration a few measurements might be disabled.

The figure below shows the complete aspect of this screen (only two lines can be seen at a time, use the UP and DOWN keys to scroll through it):

Fwd Pwr	2.94	kW
Rfl Pwr	1.4	W
SWR	Off	
InP Pwr	21.2	W
Int SWR	Off	W

### 5.3.3 Power Amplifier Menu (P.A.)

This screen, consisting of several lines that may be scrolled through by using the UP and DOWN keys, displays all the measurements associated with the RF amplifier of the equipment:

- Voltage (VPA)
- Current (IPA)
- Efficiency
- Temperature
- Power Supply Voltage (Mains - percentage variation as compared to the nominal voltage)

The figure below shows the complete aspect of this screenful (only two lines can be seen at a time, use the UP and DOWN keys to scroll through it):

VPA	49.8	V
IPA	55.3	A
Eff.	68.3	%
Temp.	38.3	C
Mains	+1	%

### 5.3.4 Warning threshold setting menu

As mentioned in the introduction the amplifier offers three settable warning thresholds. Each one is compared with the level of one of the machine’s operating parameters. The results of the comparison are available on the telemetry connector, on the contacts of the optional external telemetry card and may be read on the display as “O” (open, i.e. false result) or “C” (closed, i.e. real result).

Two of the settable thresholds (**Power Good**) refer to the emitted power level whereas the reflected power quantity (**Reflected Warning**) is checked for the third one.



The limit voltages of the quantities monitored by the warning thresholds for are the follows:

- Forward Power      3000 W      (mod. **PJ3000M-C**)
- Forward Power      2500 W      (mod. **PJ2500M-C**)
- Forward Power      2000 W      (mod. **PJ2000M-C**)
- Reflected Power      200 W

Proceed as follows to change the values of the warning thresholds:

- Select the line to be changed (with the UP and DOWN keys)
- Press the ENTER key
- Change the threshold value (UP and DOWN keys)
- Press ENTER to confirm

The figure below shows a configuration example of this menu.

```

PwrGd1 > 80 % 0
PwrGd2 > 50 % 0
Rf1War > 40 % 0
  
```

In this example the alarm thresholds are as follows:

- PwrGd1              2400 W      (80% x 3000 W x mod. **PJ3000M-C**)  
                          2000 W      (80% x 2500 W x mod. **PJ2500M-C**)  
                          1600 W      (80% x 2000 W x mod. **PJ2000M-C**)
- PwtGd2              1500 W      (50% x 3000 W x mod. **PJ3000M-C**)  
                          1250 W      (50% x 2500 W x mod. **PJ2500M-C**)  
                          1000 W      (50% x 2000 W x mod. **PJ2000M-C**)
- Rf1War              80 W      (40% x 200 W)

### 5.3.5 Alarm Menu

This menu provides information about the status of the amplifier's built-in protection system.

It consists of a certain number of lines each of which contains the name of the variable controlled by the protection system and the type of intervention carried out by the system.

Said intervention may be as follows: **X - (Y)**, **Wait**, or **Dis.** (Disabled).

The aspect of this menu is as follows (only two lines can be seen at a time, use the UP and DOWN keys to scroll through it):

```

Fwd Pwr  0-(8)
Rfl Pwr  0-(8)
InP Pwr  0-(8)
U.P.A.   Dis.
I.P.A.   0-(8)
Temp.    Wait
Int SWR  Dis.
Mains    Wait
SWR      Dis.
Eff.     Dis.
    
```

The task of this menu is essentially to help the technician in identifying the possible causes of any malfunction.

### 5.3.6 Miscellaneous Menu

In this menu the user may:

- set the address in the serial bus connection, type I<sup>2</sup>C
- set the main menu display mode

```

I2C Addr:  1
Display : Dig.
    
```

The network address I<sup>2</sup>C is very important when the amplifier is connected in an RVR transmission system that envisages the use of this protocol. Do not change it for any reason whatsoever.

The main menu may be displayed either in **Digital** mode (this is the standard mode) or **Analog** mode:

```

Rfl Pwr  1.4 ▾
■■
    
```

In the analog display mode a small triangle indicates the reflected power level set in the Alarm Threshold Setting Menu (RflWar), whereas the bar at the bottom shows the instant reflected power level.

This type of display might be useful when a device to be tuned is connected to the amplifier's output such as a cavity.

## 5.3.7 Version Menu

This screenful shows the hardware version (H.V.) and the software version (S.V.) of the equipment.



```
H.V. 1.01
S.V. 2.01
```

## 5.4 Protection System

The protection system implemented inside the amplifier is based on two types of intervention.

The first reaction is called “Foldback” and consists in decreasing the voltage in the power amplifier when the forward or reflected power exceeds the proportional limit voltage value. As such, the amplifier’s gain is reduced and the overall result is an action that opposes the increase of the forward or reflected power. The yellow LED on the front panel indicates the tripping of the foldback circuit.

The second type of reaction consists in turning OFF the equipment’s amplifying section when a specific variable exceeds a set value.

Depending on the type of event occurred, and after the amplifier has been turned OFF, it will be reactivated after a set length of time or only after the sharing, which caused the locking, has been cleared. In the alarm menu the first type of configuration is indicated by **X - (Y)**, whereas the second one is indicated by **Wait**. The third possibility is that the system does not trigger the protection conforming to a specific parameter: this is indicated by **Dis.** (Disabled).

While the amplifier is OFF temporarily owing to an alarm, the yellow WAIT LED lights up and the reason the protection was triggered is shown on the display.

When the protection system trips due to a “cyclic” type parameter, a counter begins counting up (the X value in the alarm menu). If the counter reaches the max admissible cycle value (Y), the amplifier turns OFF definitely and the red “FAULT” LED lights up on the front panel.

The user may press the ALARMS RESET key to interact with the protection system. The effect differs depending on the machine’s status when the key is pressed:

- If the equipment is off, waiting for the cycle time to be reached, or if it is definitively off in FAULT state, press the ALARMS RESET button to immediately turn the amplifier ON and reset the alarm counters.
- SIf the system is transmitting but alarms were triggered earlier causing certain counters not to be at “0”, pressing the key will have no effect unless it is pressed while inside the alarm menu. As such, the system will be sure that the user takes note of the alarms that were triggered before resetting them.

The system resets the alarm counters automatically after thirty minutes of operation, i.e. the user need not do anything, if the amplifier does not trigger any alarms or after the machine the machine has been turned OFF and then back ON.

## 5.4.1 RF module auxiliary protection

The amplifier's RF module contains a second microcontroller that manages local measurements and carries out auxiliary protection functions of the machine together with the main protection system. This microcontroller card indicates its interventions via the LEDs of the RF module.

A delivered power automatic back-off mechanism is envisaged for excess temperature, SWR or current absorbed by a MOSFET module. The yellow FOLDBACK LED indicates this case.

A FAULT signal is triggered (red LED) when a fault occurs that stops the power amplifier. This situation is signaled to the machine's main microcontroller as well and triggers a lock situation (FAULT).

The LED FUSE BLOWN indicates that one of the fuses that protects the power supply of the MOSFET modules has blown. In this case the machine keeps running as usual (obviously without the contribution of the module) even if it is advisable to single out and clear the cause for the malfunction and replace the fuse as soon as possible to fully restore the machine's working efficiency.



**Note:** Il pulsante RESET sul modulo PS resetta anche le protezioni ausiliarie del modulo RF.

## 5.4.2 Power Supply Units

Three power supply units, which work in parallel mode, power the machine. Should one of the power supply units malfunction, the machine automatically reduces the delivered power down to a value compatible with the current deliverable from the surviving power supply. This situation is indicated by the "P.S. ALARMS" LEDs on the front panel of the PS module.

## 6 External Description

This chapter describes the elements presents on the panels of the **PJ3000M-C**, **PJ2500M-C** and **PJ2000M-C**.

### 6.1 PS Module Frontal Panel

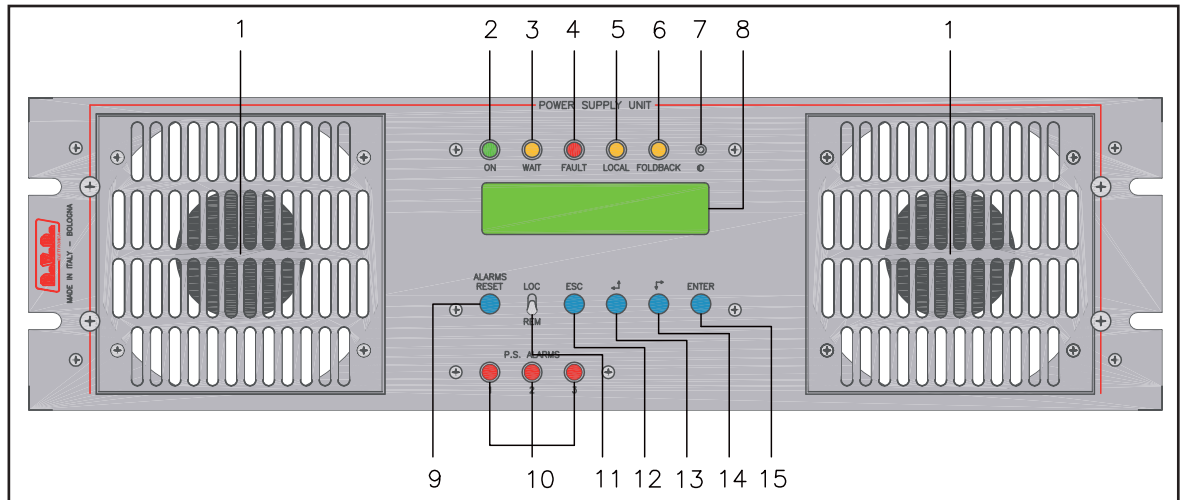

- |                   |  |
|-------------------|--|
| [1] AIR FLOW      | Grill for the ventilation flow passage   |
| [2] ON            | Green LED indicating the amplifier is switched on  |
| [3] WAIT          | Yellow LED indicating the amplifier is waiting for a condition that is blocking the power output to be removed |
| [4] FAULT         | Red LED indicating that a fault that cannot be automatically reverted  |
| [5] LOCAL         | Yellow LED, indicating that the amplifier is in local control mode   |
| [6] FOLDBACK      | Yellow LED, indicating that the foldback function is active (automatic reduction of the distributed power)     |
| [7] CONTRAST      | Trimmer to regulate the contrast of the LCD display  |
| [8] DISPLAY       | LCD display  |
| [9] ALARM RESET   | Button used to manually reset the protection system  |
| [10] P.S. ALARMS  | Yellow LEDs, indicating the presence of a anomaly on one or more power supply boards                           |
| [11] LOC/REM      | Switch to select the local or remote control modes   |
| [12] ESC          | Button used to exit from a menu  |
| [13] SINISTRA/SU' | Button used to navigate in the menu system and to modify the changeable parameters                             |
| [14] DESTRA/GIU'  | Button used to navigate in the menu system and to modify the changeable parameters                             |
| [15] ENTER        | Button used to accept a parameter's value or to enter into a menu  |

## 6.2 PS module Rear Panel

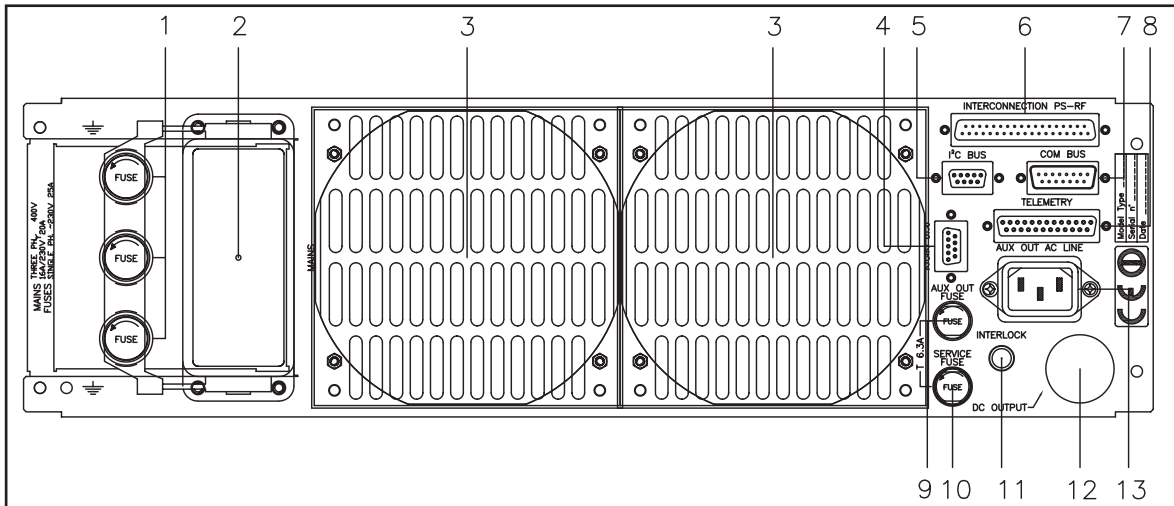

- |                           |   |
|---------------------------|---|
| [1] MAINS FUSE            | Protection fuses of the power supplies 1,2 and 3  |
| [2] MAINS CONNECTOR       | Plug for mains power supply   |
| [3] AIR FLOW              | Grill for the ventilation flow passage  |
| [4] RS232                 | DB9 connector to interface with external devices or factory programming   |
| [5] I <sup>2</sup> C BUS  | DB9 connector for I <sup>2</sup> C bus networking   |
| [6] INTERCONNECTION PS-RF | DB37 connector for interfacement with RF part   |
| [7] COM BUS               | DB15 connector for interfacement with other equipment   |
| [8] TELEMETRY             | DB25 telemetry connector  |
| [9] AUX OUT FUSE          | Protection fuse of the auxiliary plug   |
| [10] SERVICE FUSE         | Protection fuse for the service section   |
| [11] INTERLOCK            | BNC connectors to inhibit an external device, as an exciter. In case of fault, the inner connector is shorted to ground |
| [12] DC OUTPUT            | Presa per l'alimentazione della parte RF  |
| [13] AUX OUT AC LINE      | Auxiliary VDE plug to supply external devices (typically an exciter)  |

## 6.3 Connector Description

### 6.3.1 Telemetry Connector

Type: DB25 Female

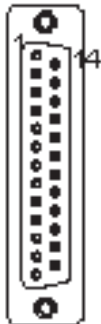

1	Internal SWR	3,9V x 1/2W
2	Tensione dell' amplificatore di potenza RF	3,9V x 50V
3	GND	GND
4	Reflected Power	4.3V x 200W
5	Interlock	
6	Set 4	
7	GND	GND
8	"On" Command	
9	Set 1	
10	WAIT	
11	Reset alarm	
12	OFF	
13	Interlock	
14	Temperature	3.9V x 100°
15	RF power amplifier current	3.9V x 75A
16	Forward Power	4.3V x F.S.
17	FAULT	
18	Set 3	
19	Input power	3.9V x 50W
20	"OFF" Command	
21	GND	GND
22	Set 2	
23	LOC	
24	+Vcc	
25	ON	

### 6.3.2 RS 232

Type: DB9 female



1	NC
2	TX_D
3	RX_D
4	Internally connected with 6
5	GND
6	Internally connected with 4
7	Internally connected with 8
8	Internally connected with 7
9	NC

## 6.3.3 I<sup>2</sup>C Connector

Type: DB9 Female

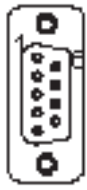

1	NC	
2	SDA	Serial Data
3	SCL	Serial Clock
4	NC	
5	GND	GND
6	NC	
7	NC	
8	NC	
9	NC	

## 6.3.4 Com Bus

Type: DB15 male

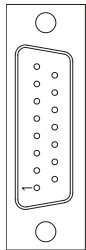

1	GND
2	485+
3	485-
4	GND
5	ON OFF C
6	INP PWR
7	ST BY
8	IRQ
9	GND
10	PWR REG
11	GND
12	NC
13	NC
14	NC
15	NC



## 6.3.5 Interconnection PS-RF

Type: DB37 female

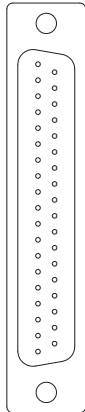

- |    |   |
|----|---|
| 1  | GND, Internally connected with 12/14/15/23/25/26/28/31/33 |
| 2  | V TOT   |
| 3  | R PWR   |
| 4  | TEMP  |
| 5  | PS OFF  |
| 6  | PS REG  |
| 7  | PWR REG   |
| 8  | ON OFF  |
| 9  | IRQ   |
| 10 | CLIX  |
| 11 | RESET AL  |
| 12 | GND, Internally connected with 1/14/15/23/25/26/28/31/33  |
| 13 | 485+  |
| 14 | GND, Internally connected with 1/12/15/23/25/26/28/31/33  |
| 15 | GND, Internally connected with 1/12/14/23/25/26/28/31/33  |
| 16 | NC  |
| 17 | AC3, Internally connected with 35                         |
| 18 | NC  |
| 20 | I TOT   |
| 19 | AC4, Internally connected with 37                         |
| 21 | F PWR   |
| 22 | INP PWR   |
| 23 | GND, Internally connected with 1/12/14/15/25/26/28/31/33  |
| 24 | PS STATUS   |
| 25 | GND, Internally connected with 1/12/14/15/23/26/28/31/33  |
| 26 | GND, Internally connected with 1/12/14/15/23/25/28/31/33  |
| 27 | ST BY   |
| 28 | GND, Internally connected with 1/12/14/15/23/25/26/31/33  |
| 29 | FAULT   |
| 30 | FUSE PS   |
| 31 | GND, Internally connected with 1/12/14/15/23/25/26/28/33  |
| 32 | 485-  |
| 33 | GND, Internally connected with 1/12/14/15/23/25/26/28/31  |
| 34 | NC  |
| 35 | AC3, Internally connected with 17                         |
| 36 | NC  |
| 37 | AC4, Internally connected with 19                         |

## 6.4 RF Module Frontal Panel

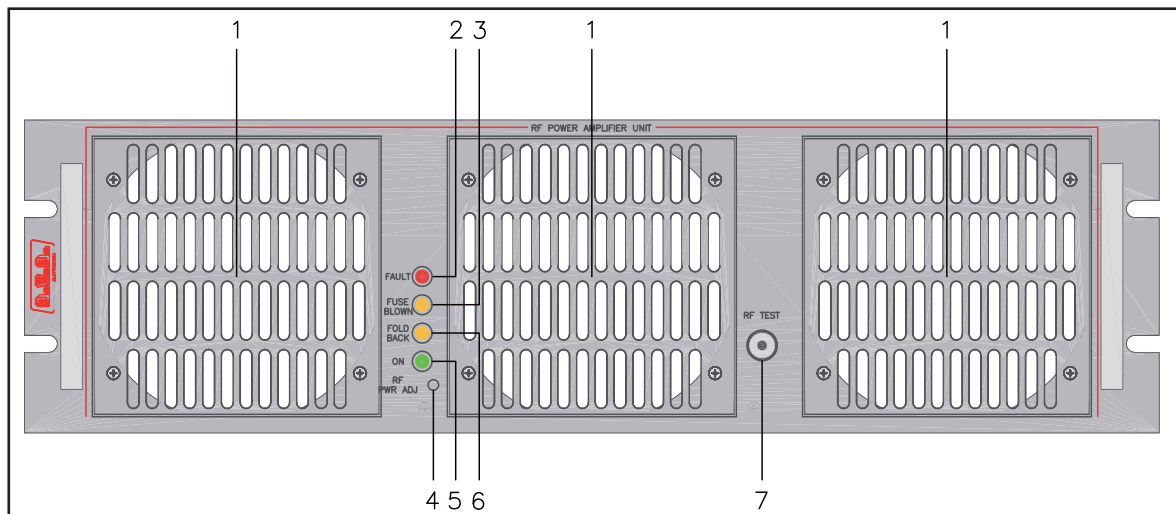

- |                |   |
|----------------|---|
| [1] AIR FLOW   | Grill for the ventilation flow passage  |
| [2] FAULT      | Red LED that indicates a fault that cannot be automatically reverted  |
| [3] FUSE BLOWN | Red LED that indicates the presence of one or more broken fuses   |
| [4] RF PWR ADJ | Power regulation trimmer - A.G.C. control   |
| [5] ON         | Green LED indicating that the amplifier is switched on  |
| [6] FOLDBACK   | Yellow LED indicating that the foldback function is active (automatic reduction of the distributed power)         |
| [7] RF TEST    | BNC connector for RF monitor output. The output level is -60dB referred to the power output in 87.5-108 MHz range |

## 6.5 RF module Rear Panel

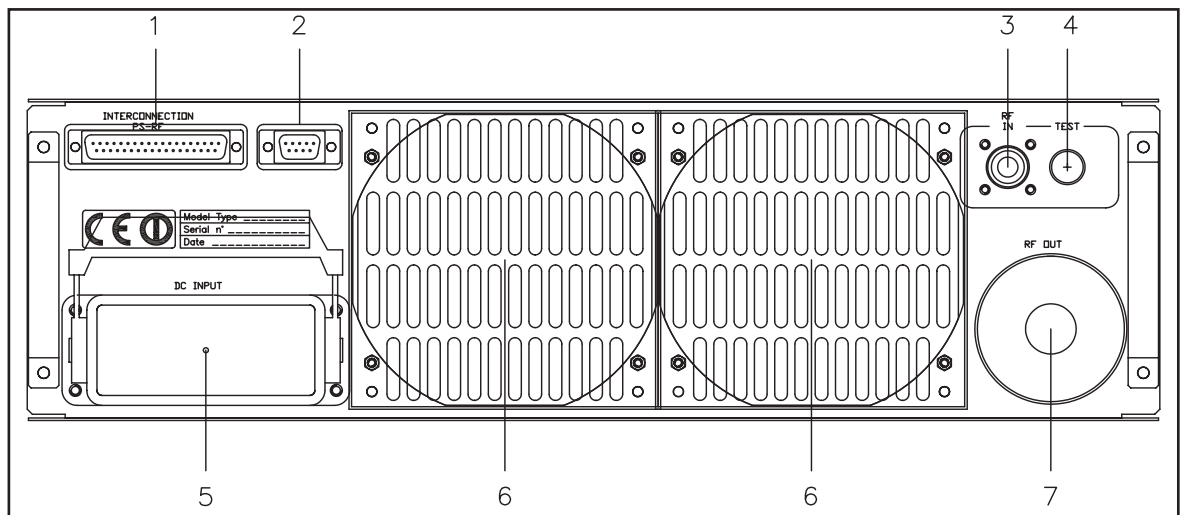

- |     |                       |  |
|-----|-----------------------|--|
| [1] | INTERCONNECTION PS-RF | DB37 connector for interfacement with PS part                          |
| [2] |                       | DB9 connector reserved for future uses                                 |
| [3] | RF IN                 | RF input connector ("N" type)  |
| [4] | RF IN TEST            | Connector for the drawn not standardized of the modulator input signal |
| [5] | PLUG                  | Plug for the supply of 50V <sub>DC</sub> incoming from module PS       |
| [6] | AIR FLOW              | Grill for the ventilation flow passage                                 |
| [7] | RF OUT                | RF output connector (7/8" EIA flange)                                  |

## 6.5.1 Interconnection PS-RF

Type: DB37 female

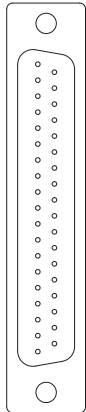

- 1 GND, internally connected with 12/14/15/23/25/26/28/31/33
- 2 V TOT
- 3 R PWR
- 4 TEMP
- 5 PS OFF
- 6 PS REG
- 7 PWR REG
- 8 ON OFF
- 9 IRQ
- 10 CLIX
- 11 RESET AL
- 12 GND, internally connected with 1/14/15/23/25/26/28/31/33
- 13 485+
- 14 GND, internally connected with 1/12/15/23/25/26/28/31/33
- 15 GND, internally connected with 1/12/14/23/25/26/28/31/33
- 16 NC
- 17 AC3, internally connected with 35
- 18 NC
- 20 I TOT
- 19 AC4, internally connected with 37
- 21 F PWR
- 22 INP PWR
- 23 GND, internally connected with 1/12/14/15/25/26/28/31/33
- 24 PS STATUS
- 25 GND, internally connected with 1/12/14/15/23/26/28/31/33
- 26 GND, internally connected with 1/12/14/15/23/25/28/31/33
- 27 ST BY
- 28 GND, internally connected with 1/12/14/15/23/25/26/31/33
- 29 FAULT
- 30 FUSE PS
- 31 GND, internally connected with 1/12/14/15/23/25/26/28/33
- 32 485-
- 33 GND, internally connected with 1/12/14/15/23/25/26/28/31
- 34 NC
- 35 AC3, internally connected with 17
- 36 GND, Internally connected with PIN34 of JP5 of the Bias board SLMTPRTPJ4K1(mod. **PJ3000M-C**).  
NC (mod. **PJ2000M-C & PJ2500M-C**)
- 37 AC4, internally connected with Internamente connesso con 19

## **7.**

### **7.1**

*This page was intentionally left blank*



*This page was intentionally left blank*

*This page was intentionally left blank*

## 8. Operating theory

The figure shows the PS and the RF part of amplifier seen from above. The various cards are described in this chapter.

- Top View of PS section with PFC:

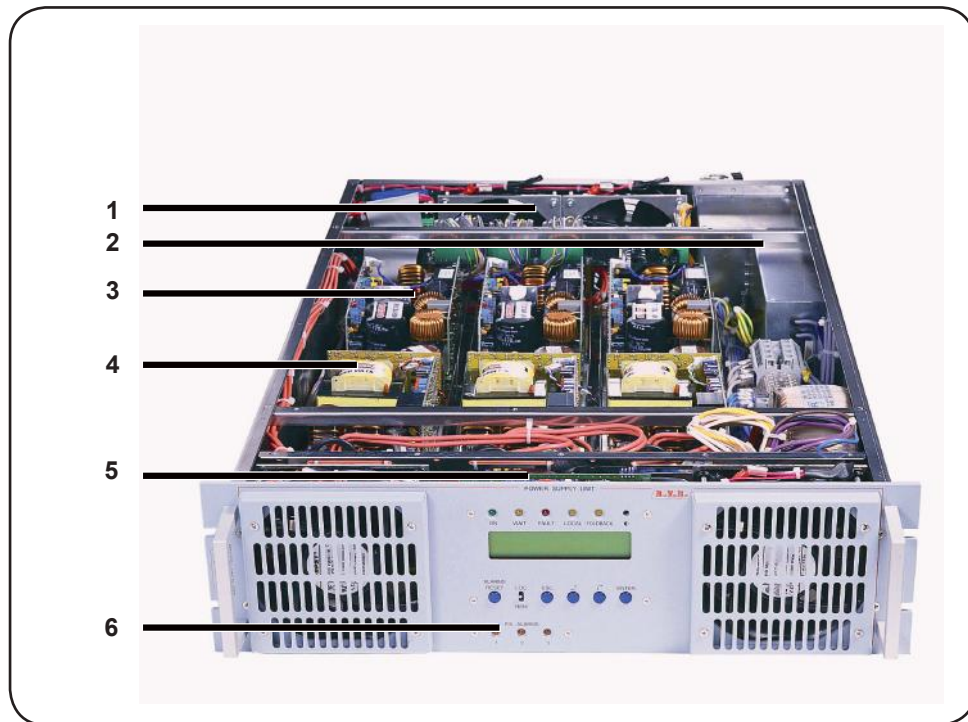

- 1) PS-RF Interface Board  
**SLINPSP2K01 (PJ2000M-C & PJ2500M-C) / SLINPSP2K03 (PJ3000M-C)**
- 2) Surge Protection Board **SLSRGPRPJ2K1**
- 3) PFC  
**PFCPSL1000 (PJ2000M-C & PJ2500M-C) / PFCPSL5037 (PJ3000M-C)**
- 4) Power Supply  
**PSL1000/PJ2K (PJ2000M-C & PJ2500M-C) / PSL5037 (PJ3000M-C)**
- 5) CPU Board (**PROTPJ-HCL**)
- 6) LEDs Board  
**SLLEDPSPJ2K2 (PJ2000M-C & PJ2500M-C) / SL046LD1001 (PJ3000M-C)**



- Top View of PS section with Rectifier (only **PJ2000M-C** e **PJ2500M-C**)

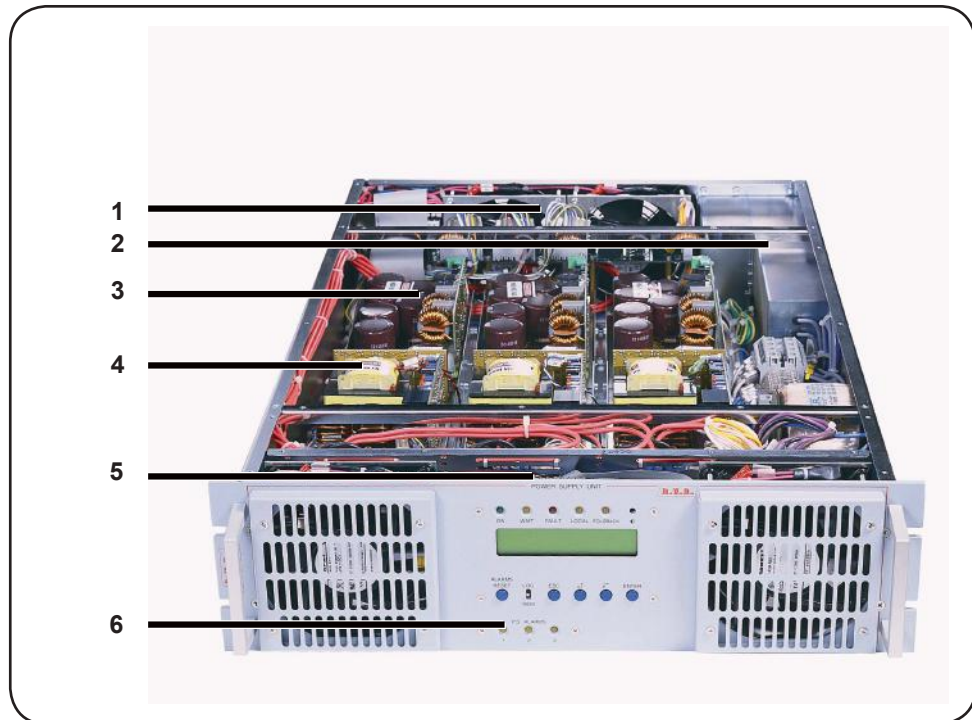

- 1) PS-RF Interface board **SLINPSP2K01**
- 2) Surge Protection Board **SLSRGPRPJ2K1**
- 3) Rectifiers **RCTPSL1000**
- 4) Power Supply **PSL1000/PJ2K**
- 5) CPU Boards **PROTPJ-HCL**
- 6) LEDs Boards **SLLEDPSPJ2K2**

- Top View of RF section (mod. **PJ3000M-C**)

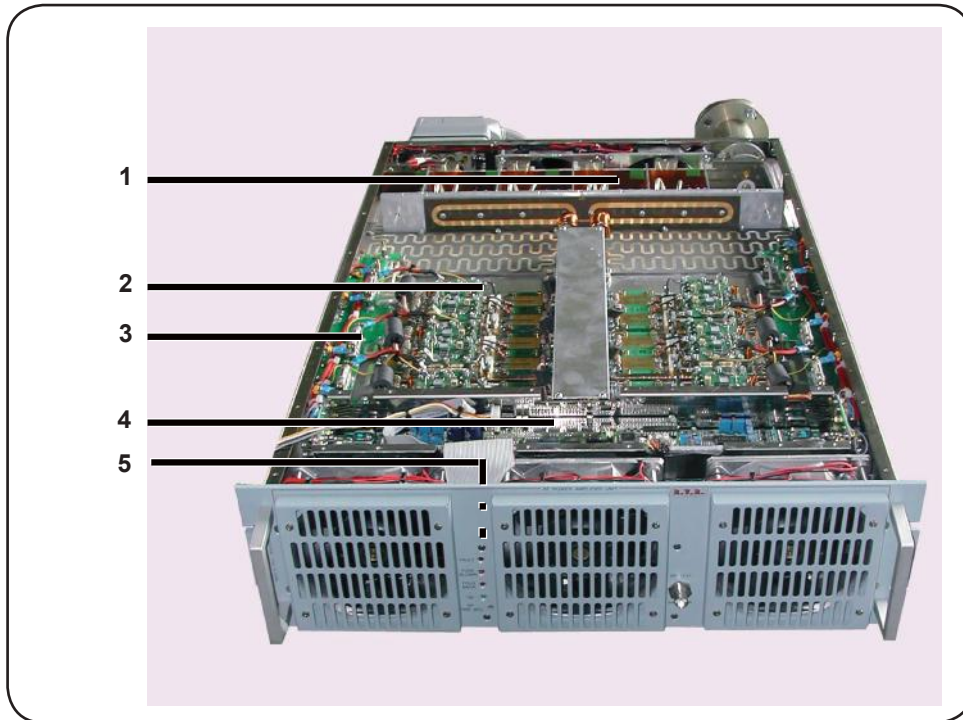

- 1) Low-pass Filter Board **SLLPFPJ2KLST**
- 2) Amplifier Modules **SL046RF1001**
- 3) Fuses Board **SLFUSRFPJ4K1**
- 4) Bias Boards **SLMTPRTPJ4K1** & CPU Board **CPUPJ2KMC**
- 5) LEDs Boards **SLLEDRFPJ2K1**

- Top view of RF section (mod. **PJ2500M-C** & **PJ2000M-C**)

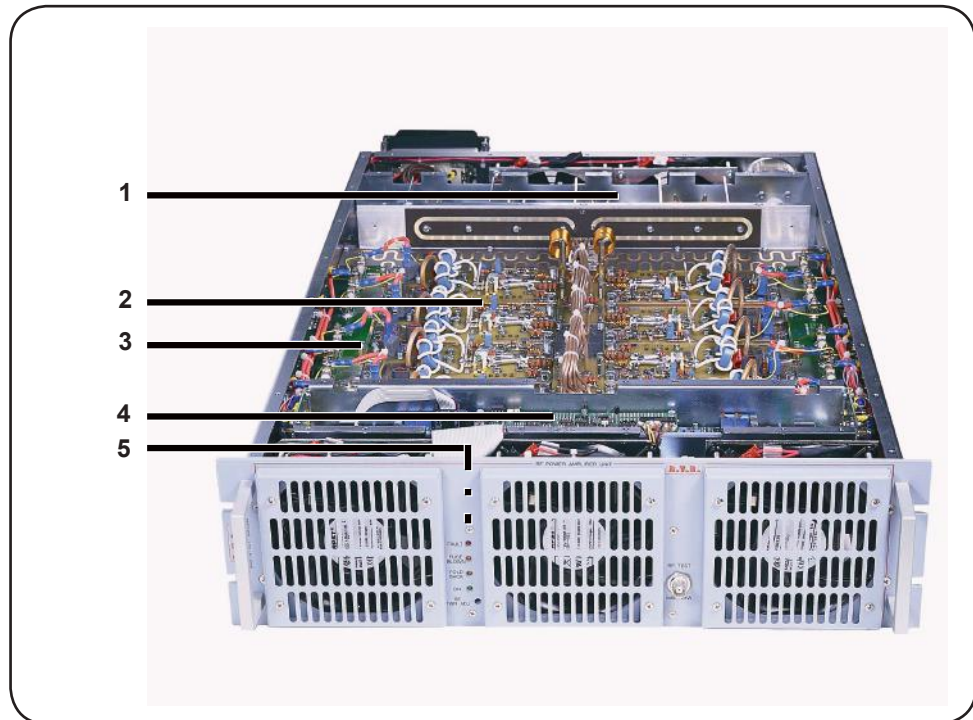

- 1) Low-pass Filter Board **SLLPFPJ2KLST**
- 2) Amplifier Modules  
**SL042RF1001** (mod. **PJ2000M-C**) / (**SL010RF4001**) mod. **PJ2500M-C**
- 3) Fuses Board **SLFUSRFPJ2K1**
- 4) Bias Boards **SLMTPRTPJ2K1** & CPU Board **CPUPJ2KMC**
- 5) LEDs Boards **SLLEDRFPJ2K1**

## 8.1 Power Supply Change

To use the amplifier with different types of power supply you should connect the mains power supply socket as outlined in chapter 5. Also modify the connections inside the varistors board box as explained below.

In order to access the varistors board box, remove the screws from the side and back of the PS module, which keep it in place, and take out the box.

8.1.1 Single-Phase Wiring

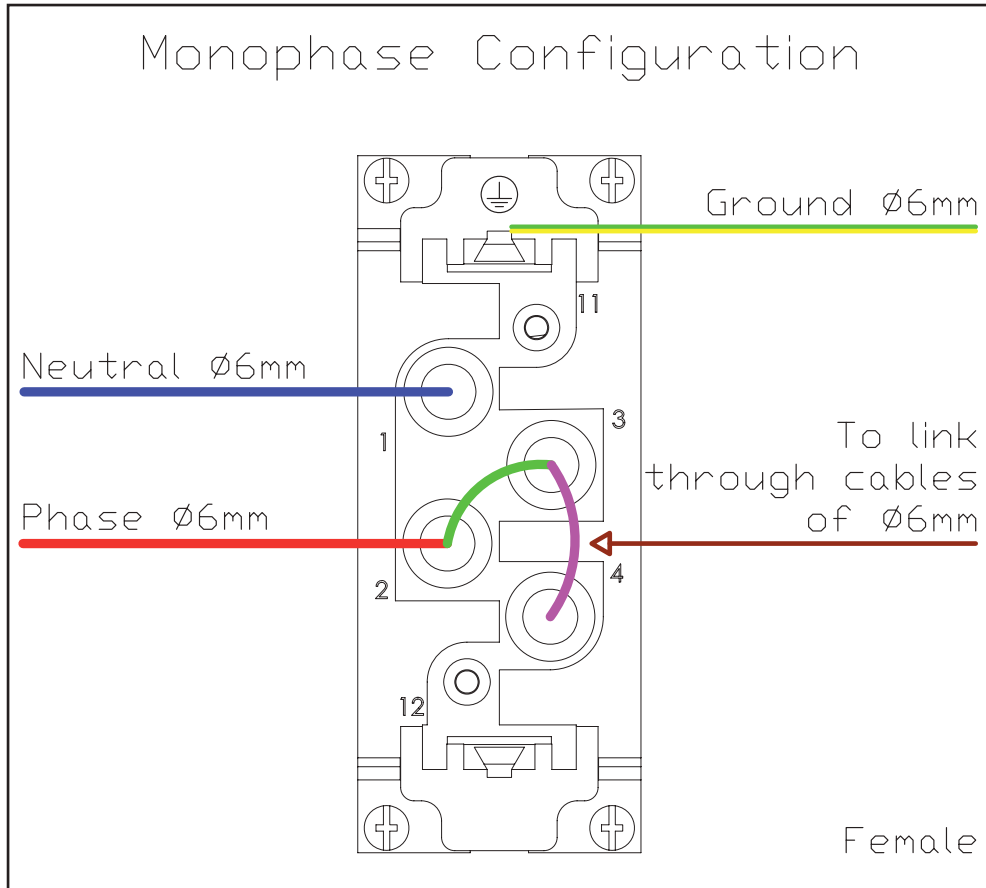

**WARNING:** the power supply in single-phase can be used only with 208/230V voltage.

For the single-phase, the configuration of the external power supply plug must have the following characteristics:

- PIN1 of the main connector is connected to Neutral wire.
- PIN2 of the main connector is connected to Phase wire and internally connected to PIN3 by Ø 6mm wire.
- PIN3 of the main connector is internally connected to PIN2 and to PIN4 by Ø 6mm wire.
- PIN4 of the main connector is internally connected to PIN3 by Ø 6mm wire.
- PIN5 is directly wired to ground.

## 8.1.2 Three-Phase Wiring

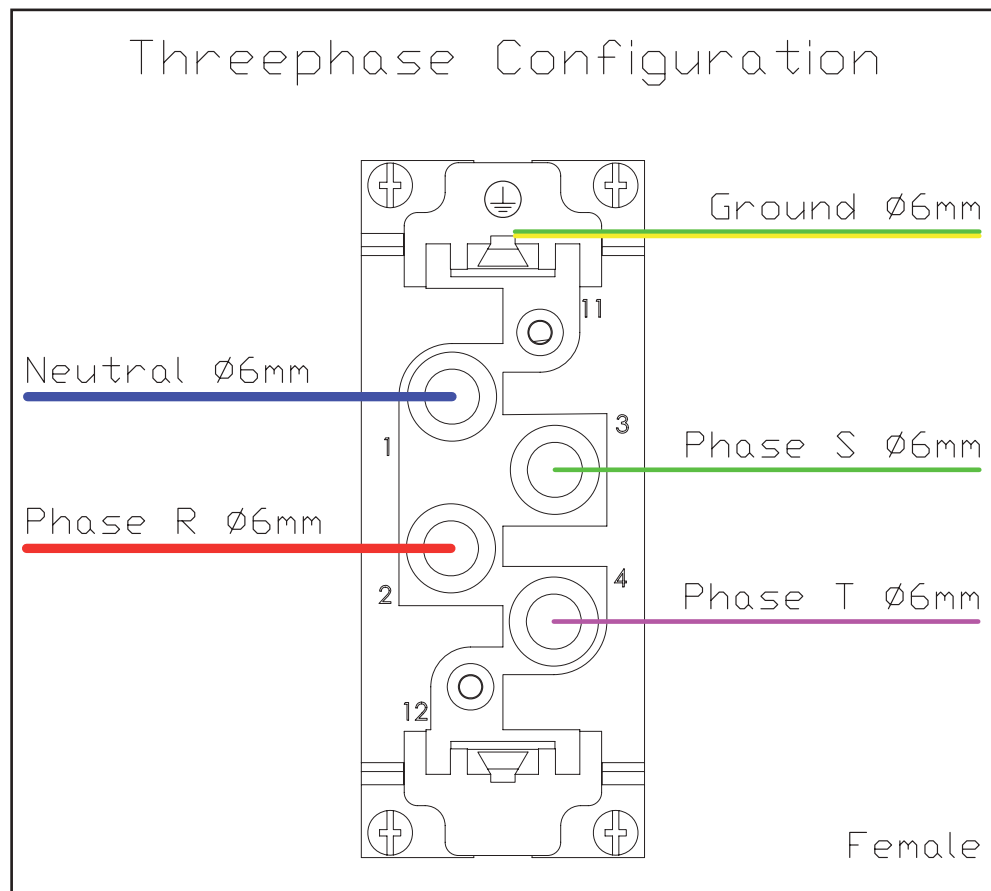

For the three-phase, the configuration of the external power supply plug must have the following characteristics:

- PIN1 of the main connector is connected to Neutral wire.
- PIN2 of the main connector is connected to Phase R Wire.
- PIN3 of the main connector is connected to Phase S Wire.
- PIN4 of the main connector is connected to Phase T Wire.
- PIN5 is directly wired to ground.

### 8.1.3 Voltage Change



**WARNING:** the single-phase power supply may be used only with 208/230 Volts.

Proceed as follows to change voltage inside the machine:

- Make the JP3 connection, on the Rectifier card, between PIN 1 and 2 to select 230 Volts, or between PIN 2 and 3 for 115 Volts.

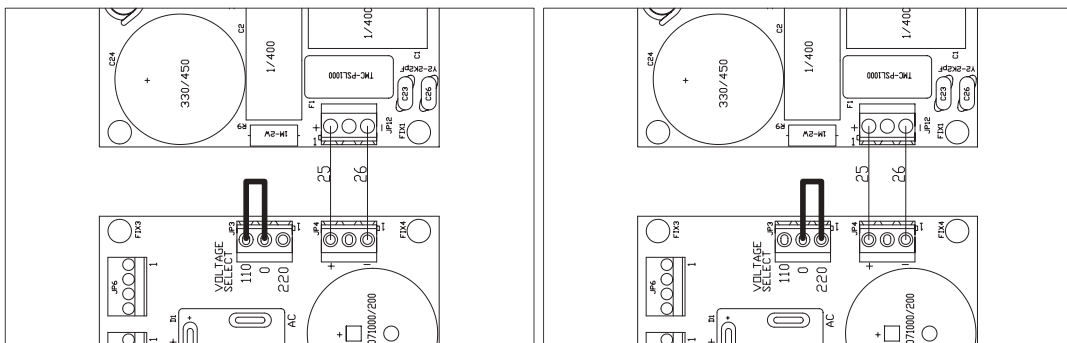
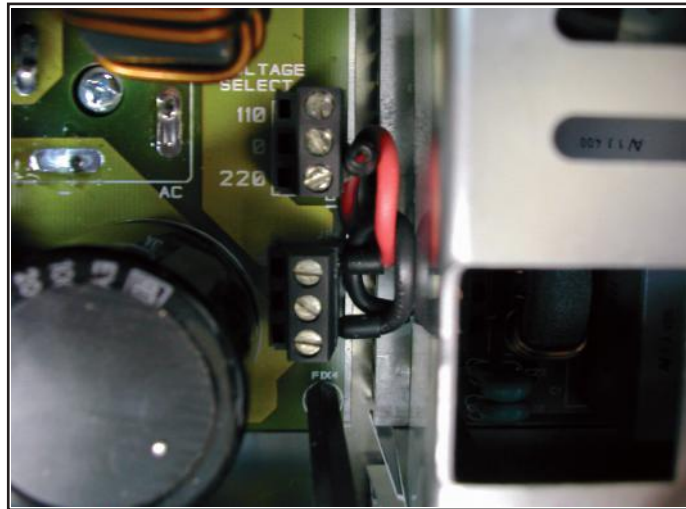

Figure 8-1: Connection for the selection of 115 or 208/230 Volts

- In order to select the 230 Volts on the connector inside the PS section near the transformer, make the connection between PIN 3 and 4 and PIN 6 and 7, or between PIN 2 and 3 and PIN 5 and 6 for 115 Volts.

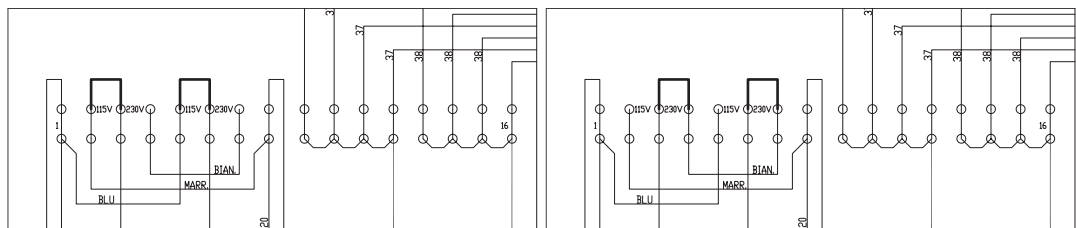

Figure 8-2: Connection for the selection of 115V or 208/230V three phase with neutral wire

## 8.2 PS Part

### 8.2.1 Surge Protection

This card's main function is to avoid any damage to the internal cards by blocking the contact before current reaches the equipment in case overvoltages occur.

### 8.2.2 Power Supply

The three power supply modules are located in the middle part of the amplifier. The power supply units are mounted on a cooling fin to cool the amplifier by forced ventilation.

The amplifier houses a transformer the input voltage of which may be selected between 115 and 230 Volts.

The transformer is fitted with three secondary wires: A) 18-0-18 V, B) 0-17 V, C) 0-11.5 V that supply power to the cards inside the equipment.

### 8.2.3 PFC Unit or Rectifier

The PFC unit is a rectifier that modulates the current absorbed so that the wave shape is the most possible sinusoidal, obtaining a factor of power of 99%.

The PFC can work with input supply voltages from 90 V to 250 V. A rectified voltage of 350 V is present on the output.

In place of PFC units, can be installed “traditional” rectifiers units (without power factor corrector). Its task is to rectify and stabilize the shape of the voltage produced by the power supply modules by fixing the voltage value to the value required by the internal circuitry.

This card also applies a resistive load when the amplifier is turned on and excludes said load after a short time to reduce current peaks in the transformer on turning it on (*SOFT-START*).

## 8.2.4 PS-RF Interface Board

This interface board is installed at the back of the amplifier for collecting the main signals of the machine and making them available on the connectors. This interface is connected to the three rectifiers, the CPU, the fans, the transformer from which it receives the signals and to which it issues commands.

This interface card is designed to make the PS part communicate with the RF part and making available the dedicated signals at the specific connector for each part.

## 8.2.5 LEDs Board

Three LEDs are present on this board for indicating the operating status of the three power supply modules.

The lighting up of a LED indicates a malfunction in the associated module.

## 8.2.6 CPU

This subsystem is made up of three cards: the CPU card, the display card and the analog card.

The CPU subsystem implements all the software functions (measurements, protection, control, data display, communications) outlined in the previous chapters.

This card carries the signals to the DB25 telemetry connector that is on the machine’s back panel. The connector is fitted with 7 analog outputs, 8 open-collector digital outputs and 4 digital inputs. It also manages the DB9 signals associated with the RS232 connector, for interfacing with other equipment and for the default programming functions, and the DB9 connector for communications in I<sup>2</sup>C standard.



## 8.3 RF Part

### 8.3.1 RF Power Amplifier

The RF power amplifying section consists in 8 (mod. **PJ2000M-C** & **PJ2500M-C**) or 6 (mod. **PJ3000M-C**) power modules coupled by a Wilkinson splitter and combiner and implemented in strip-line technology.

The RF modules, the splitter and the combiner are housed inside the top part of the equipment.

The whole RF section is mounted on the fin that cools the equipment by means of forced ventilation.

Each RF module supplies 550 watts in **PJ3000M-C** model, 350 watts in **PJ2500M-C** model, or 300 watts in **PJ2000M-C** model, with 4 to 6 pilot power watts and is powered by the switching PSU.

The modules' operating parameters in standby are as follows:

VDC=50V   Vgs=3.5V   Idq=200mA

The active device used in the amplifier modules is a Mosfet (2x BLF278 in **PJ3000M-C** model, SD2942 in **PJ2500M-C** model, or BLF278 in **PJ2000M-C** model).

### 8.3.2 Wilkinson Splitter and Combiner

Both the splitter and the combiner are made in strip-line technology.

The splitter is used for splitting power arriving from the exciter and supplying one part to each of the RF modules.

The combiner is then used to combine power output from each module to obtain the amplifier's total power.

The two cards ensure equal phases among the powers generated by the RF modules. One power resistance is used for dissipating the offset power that might be present in case a module breaks down.

The Splitter card is also fitted with the temperature sensor which is monitored by the software.

### 8.3.3 Bias Board

The task of this card is to check and correct the bias voltage of the Mosfets in the RF amplification section.

This card also supplies the following measurements: current and voltage of each

module, total current and average voltage.

## 8.3.4 Low-Pass Filter

This filter is located at the back of the equipment.

The task of the low-pass filter is to reduce the harmonic emissions of the amplifier to below the levels allowed by standards.

## 8.3.5 Directional Coupler

The task of these two cards that seem identical is to supply the power measurement. They are installed on the input RF connector on the inside of the machine. One card supplies the amplifier's forward power whereas the other one supplies the reflected power.

## 8.3.6 Control Board

The control board acts as an auxiliary card for the PROTF card in the PS section should the latter fail to trip due to a malfunction. It implements all the functions associated with measurements, protection, control and communications and is even capable of detecting the individual voltages or currents inside the machine, in addition to the overall ones.

If pre-arranged, this Board can carry the signals to the DB9 connector located on the machine's back panel in RS485 standard.

## 8.3.7 LEDs Board

This card is fitted with 4 warning LEDs that indicate the machine's general operating status.

It also has a trimmer for adjusting power (AGC control). Use a small screwdriver to change the delivered power.

## 9. “Low-Drive Power” Option (/LD)

The figure shown the top view of RF section of the equipment with LD option. The board comes described in the continuation of this chapter.

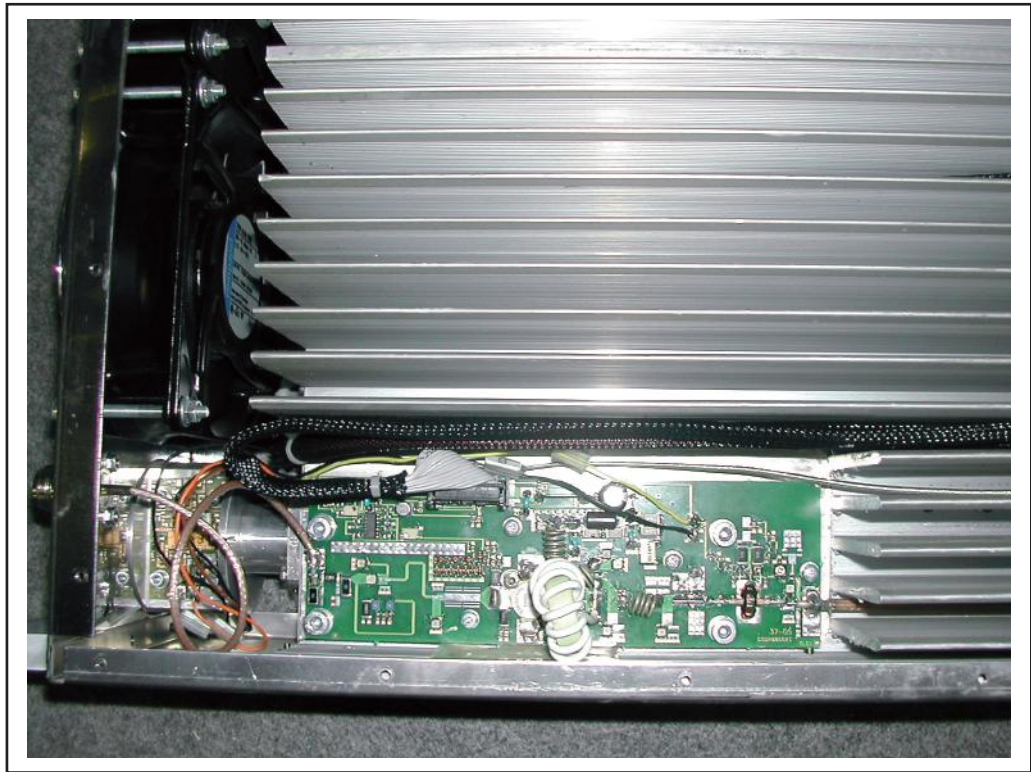

*Figure 9-1: “Low-Drive power” Board*

### 9.1 “Low-Drive power” Board

The “Low-Drive power” board contains an RF amplifier with only one stage that, with a power of about 1W, can supply an output power of approximately 30W suitable to pilot **PJ2000M-C** and **PJ2500M-C**, with a total gain of approximately 15dB.

The active device utilized in the amplifier modules is a Mosfet (BLF177) and uses for the feeding the same voltage of  $50V_{DC}$  used from the eight RF amplifiers modules.

On the output stage of this board is present a directional coupler that measure the reflected and forward power; the latest comes acquired from the control software that represents it legible like input power.

The board is mounted on the fin that supplies to its cooling through forced ventilation.



*This page was intentionally left blank*