

---

---

# Radio Modem Box

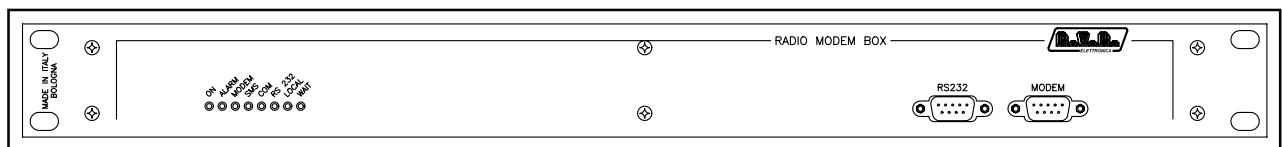

## User Manual Volume 1

---

---

Manufactured by  Italy



**File Name:** RadioModemBox\_EN.P65

**Version:** 1.0

**Data:** 24/06/2004

#### Revision History

Date	Version	Reason	Editor
24/06/04	1.0	First Version	G. De Donno

Radio Modem Box - User Manual  
Version 1.0

© Copyright 2004-2004  
R.V.R. Elettronica SpA  
Via del Fonditore 2/2c - 40138 - Bologna (Italia)  
Telefono: +39 051 6010506  
Fax: +39 051 6011104  
Email: info@rvr.it  
Web: www.rvr.it

All rights reserved

Printed and bound in Italy. No part of this manual may be reproduced, memorized or transmitted in any form or by any means, electronic or mechanic, including photocopying, recording or by any information storage and retrieval system, without written permission of the copyright owner.

# Table of Contents

<b>1. Preliminary Instructions</b>	<b>1</b>
<b>2. Warranty</b>	<b>1</b>
<b>3. First Aid</b>	<b>2</b>
3.1 Treatment of electrical shocks	2
3.2 Treatment of electrical Burns	3
<b>4. General Description</b>	<b>4</b>
4.1 Description of version with external UPS	5
4.2 Description of version with battery charger	7
<b>5. Quick Guide - Installation and Use</b>	<b>9</b>
5.1 Preparation	9
5.2 Remote Alarm Reporting Configuration	12
5.3 Remote Control	17
5.4 SMS alarm test procedure	17
<b>6. Controls, Modules and Connectors</b>	<b>20</b>
6.1 Front Panel	20
6.2 Rear Panel	20
6.3 Module identification (top view)	21
6.4 Connector Pinouts	23
<b>7. Electric diagram, layout and bill of materials</b>	<b>25</b>

*This page was intentionally left blank*

## 1. Preliminary Instructions

This manual is written as a general guide for those having previous knowledge and experience with this kind of equipment, well conscious of the risks connected with the operation of electrical equipment.

It is not intended to contain a complete statement of all safety rules which should be observed by personnel in using this or other electronic equipment.

The installation, use and maintenance of this piece of equipment involve risks both for the personnel performing them and for the device itself, that shall be used only by trained personnel.

**R.V.R. Elettronica SpA** doesn't assume responsibility for injury or damage resulting from improper procedures or practices by untrained/unqualified personnel in the handling of this unit.

Please observe all local codes and fire protection standards in the operations of this unit.



**WARNING:** always disconnect power before opening covers or removing any part of this unit. Use appropriate grounding procedures to short out capacitors and high voltage points before servicing.



**WARNING:** this device can irradiate radio frequency waves, and if it's not installed following the instructions contained in the manual and local regulations it could generate interferences in radio communications. This is a "CLASS A" equipment. In a residential place this equipment can cause hash. In this case can be requested to user to take the necessary measures.

**R.V.R. Elettronica SpA** reserves the right to modify the design and/or the technical specifications of the product and this manual without notice.

## 2. Warranty

Any product of **R.V.R. Elettronica** is covered by a 24 (twenty-four) month warranty.

For components like tubes for power amplifiers, the original manufacturer's warranty applies.

**R.V.R. Elettronica SpA** extends to the original end-user purchaser all manufacturers warranties which are transferrable and all claims are to be made directly to **R.V.R.** per indicated procedures.

Warranty shall not include:

- 1 Damage while the equipment is being shipped to R.V.R. for repairs;
- 2 Any unauthorized repair/modification;
- 3 Incidental/consequential damages as a result of any defect
- 4 Nominal non-incidentals defects
- 5 Re-shipment costs or insurance of the unit or replacement units/parts

Any damage to the goods must be reported to the carrier in writing on the shipment receipt.

Any discrepancy or damage discovered subsequent to delivery, shall be reported to **R.V.R. Elettronica** within **5** (five) days from delivery date.

To claim your rights under this warranty, you should follow this procedure

- 1 Contact the dealer or distributor where you purchased the unit. Describe the problem and, so that a possible easy solution can be detected.

Dealers and Distributors are supplied with all the information about problems that may occur and usually they can repair the unit quicker than what the manufacturer could do. Very often installing errors are discovered by dealers.

- 2 If your dealer cannot help you, contact R.V.R. Elettronica and explain the problem. If it is decided to return the unit to the factory, **R.V.R. Elettronica** will mail you a regular authorization with all the necessary instructions to send back the goods.
- 3 When you receive the authorization, you can return the unit. Pack it carefully for the shipment, preferably using the original packing and seal the package perfectly. The customer always assumes the risks of loss (i.e., R.V.R. is never responsible for damage or loss), until the package reaches R.V.R. premises. For this reason, we suggest you to insure the goods for the whole value. Shipment must be effected C.I.F. (PREPAID) to the address specified by R.V.R.'s service manager on the authorization



DO NOT RETURN UNITS WITHOUT OUR AUTHORIZATION AS THEY WILL BE REFUSED

- 4 Be sure to enclose a written technical report where mention all the problems found and a copy of your original invoice establishing the starting date of the warranty.

Replacement and warranty parts may be ordered from the following address. Be sure to include the equipment model and serial number as well as part description and part number.



R.V.R. Elettronica SpA  
Via del Fonditore, 2/2c  
40138 BOLOGNA  
ITALY  
Tel. +39 051 6010506

## 3. First Aid

The personnel employed in the installation, use and maintenance of the device, shall be familiar with theory and practice of first aid.

### 3.1 Treatment of electrical shocks

#### 3.1.1 If the victim is not responsive

Follow the A-B-C's of basic life support

- Place victim flat on his back on a hard surface.
- Open airway: lift up neck, push forehead back (**Figure 1**).
- clear out mouth if necessary and observe for breathing
- if not breathing, begin artificial breathing (**Figure 2**): tilt head, pinch nostrils, make airtight seal, four quick full breaths. Remember mouth to mouth resuscitation must be commenced as soon as possible

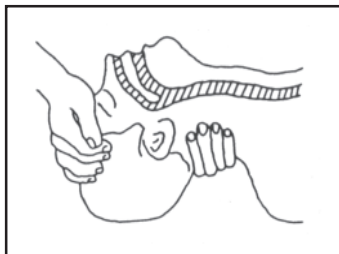

Figure 1



Figure 2

- Check carotid pulse (**Figure 3**); if pulse is absent, begin artificial circulation (**Figure 4**) depressing sternum (**Figure 5**)



Figure 3

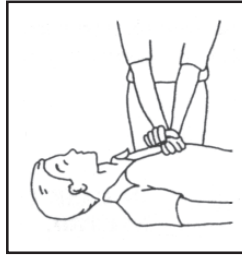

Figure 4

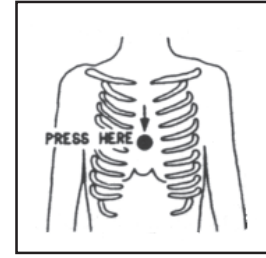

Figure 5

- In case of only one rescuer, 15 compressions alternated to two breaths.
- If there are two rescuers, the rythm shall be of one brath each 5 compressions.
- Do not interrupt the rythm of compressions when the second person is giving breath.
- Call for medical assistance as soon as possible.

### 3.1.2 If victim is responsive

- Keep them warm
- Keep them as quiet as possible
- Loosen their clothing (a reclining position is recommended)
- Call for medical help as soon as possible

## 3.2 Treatment of electrical Burns

### 3.2.1 Extensive burned and broken skin

- Cover area with clean sheet or cloth
- Do not break blisters, remove tissue, remove adhered particles of clothing, or apply any salve or ointment.
- Treat victim for shock as required.
- Arrange transportation to a hospital as quickly as possible.
- If arms or legs are affected keep them elevated

If medical help will not be available within an hour and the victim is conscious and not vomiting, give him a weak solution of salt and soda: 1 level teaspoonful of salt and 1/2 level teaspoonful of baking soda to each quart of water (neither hot or cold). Allow victim to sip slowly about 4 ounces (half a glass) over a period of 15 minutes. Discontinue fluid if vomiting occurs.



DO NOT give alcohol

### 3.2.2 Less severe burns

- Apply cool (not ice cold) compresses using the cleansed available cloth article.
- Do not break blisters, remove tissue, remove adhered particles of clothing, or apply salve or ointment.
- Apply clean dry dressing if necessary.
- Treat victim for shock as required.
- Arrange transportation to a hospital as quickly as possible
- If arms or legs are affected keep them elevated.

## 4. General Description

The Radio Modem Box produced by R.V.R. Elettronica, when interfaced with R.V.R. Elettronica devices equipped with a telemetry unit, **provides supply voltage (220V) control** and **SMS alarm signalling** through an incorporated GSM Modem.



**WARNING :** R.V.R. Elettronica devices incorporating a telemetry unit that offer Mains alarm management capabilities are: TLC300 TLC2000 (with software releases higher than 02080200), SCM1+1 LCD, SCMN+1 LCD, PTX LCD with 16-bit CPU.

Radio Modem BOX has been designed to interface directly with systems comprising PTX LCD **with 16-bit CPU** (for telemetry management) and PJ amplifier (or other non-RVR amplifier) and incorporates all necessary connections for both telemetry and mains management.

The front panel of Radio Modem Box features two RS232 (DB9) connectors for direct connection both to the telemetry unit and the incorporated GSM modem.

The rear panel features an audio input jack to test the audio signal transmitted through the GSM modem.

The Radio Modem Box is available in two versions:

- with external UPS
- with incorporated buffer battery and battery charger



## 4.1 Description of version with external UPS

Both Radio Modem Box and UPS (Uninterruptible Power Supply) unit are powered from the power mains (220V AC) through the "Mains In" connectors.

The UPS output powers the PTX LCD or SCM-TLC as well as the Radio Modem Box through the "UPS Out" connectors. This ensures proper operation and alarm signalling in the event of mains failure.

System runtime depends on UPS capacity and the following specifications must be complied with in order to ensure correct alarm signalling for 5-7 minutes as a minimum:

### TECHNICAL SPECIFICATIONS OF A TYPICAL RVR UPS

Rated capacity (VA)	600
<b>INPUT</b>	
Rated voltage	230V
Voltage range	160-290V
Frequency	47/63 Hz autorange
<b>OUTPUT</b>	
Rated capacity (VA/W)	600/360
Rated voltage	230V
Voltage in battery mode	230V $\pm$ 10%
Waveform	Pseudo-sine waveform
Frequency from battery	50/60 Hz autorange $\pm$ 1 Hz
<b>SYSTEM</b>	
Operation time	3 ms
AC-AC efficiency	98%
Battery and runtime	Lead battery, maintenance-free, 10 min. runtime at half load
Protections	Excessive discharge from accumulators, over-current, short circuit, temperature

There are several different UPS types available in the market to meet specific application requirements.

#### - Stand-by

In normal operation, the system is powered by the mains. In the event of an interruption, load is switched onto the battery. Proper operation depends on the power mains: if the power mains is poor quality or is affected by noise, the load will be switched onto the battery frequently.

#### - Active Stand-by

In normal operation, the system is powered by the mains. In the event of an interruption, load is switched onto the battery. Output voltage is regulated to ensure more efficient battery usage. Power supply quality in battery mode depends on product specifications, as certain products provide a sinusoidal signal, whereas other products provide a pseudo-sinusoidal signal.

- On-line

This is undoubtedly the most reliable design and ensures enhanced performance. In normal operation, the system is powered by the UPS, that prevents any interruption in the event of mains failure.

This design avoids any delay in terms of load switching time.

Example of external UPS version connection to PTX LCD:

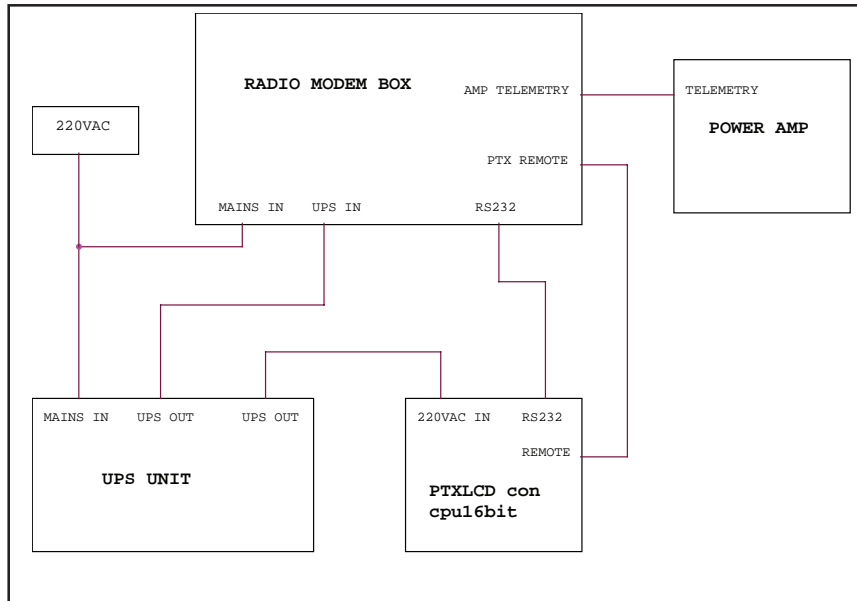

Example of external UPS version connection to TLC300:

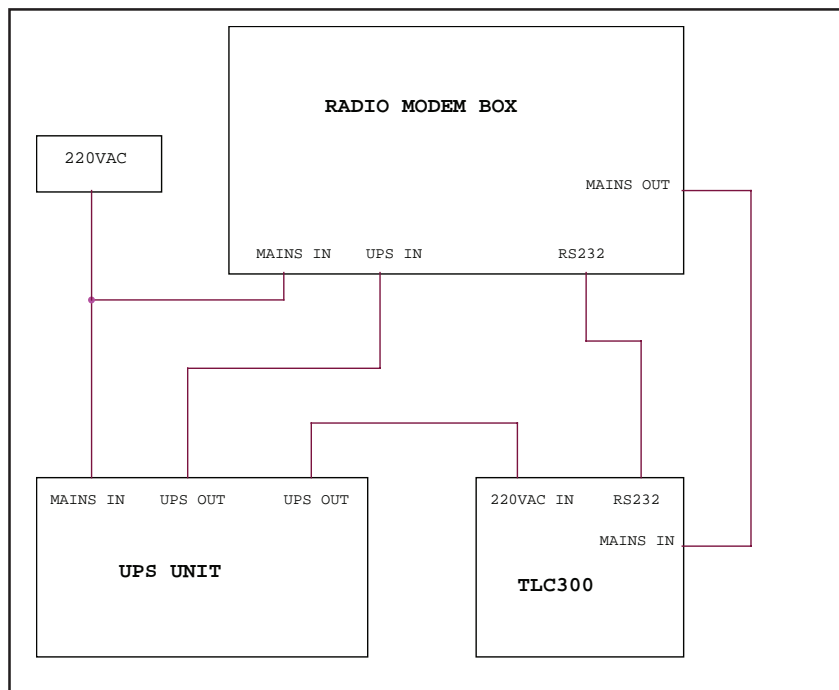

## 4.2 Description of version with battery charger

Radio Modem Box incorporates a 24V battery with battery charger. 24V supply is controlled by a selectable internal timer (after a certain period of time, voltage is cut off to avoid running the battery flat).

The GSM modem is powered from the internal 24V source.



**WARNING:** Interfacing with PTX LCD is only possible when PTX LCD has the 24V option (option /03) installed.



**WARNING:** Radio Modem Box has been designed to interface directly with the system comprising PTX LCD with 16-bit CPU (for telemetry management) and amplifier or combiner (or other non-R.V.R. Elettronica device using the "Ext. Telemetry" terminal board) as it incorporates all necessary connections for both telemetry and mains management.

The following R.V.R. Elettronica amplifiers are suitable for connection to Radio Modem Box: PJ300M, PJ501M, PJ500M, PJ1000M, PJ1000C LCD, PJ2000M-C. All HC LCD couplers are compatible with Radio Modem Box.

Example of connection to PTX LCD:

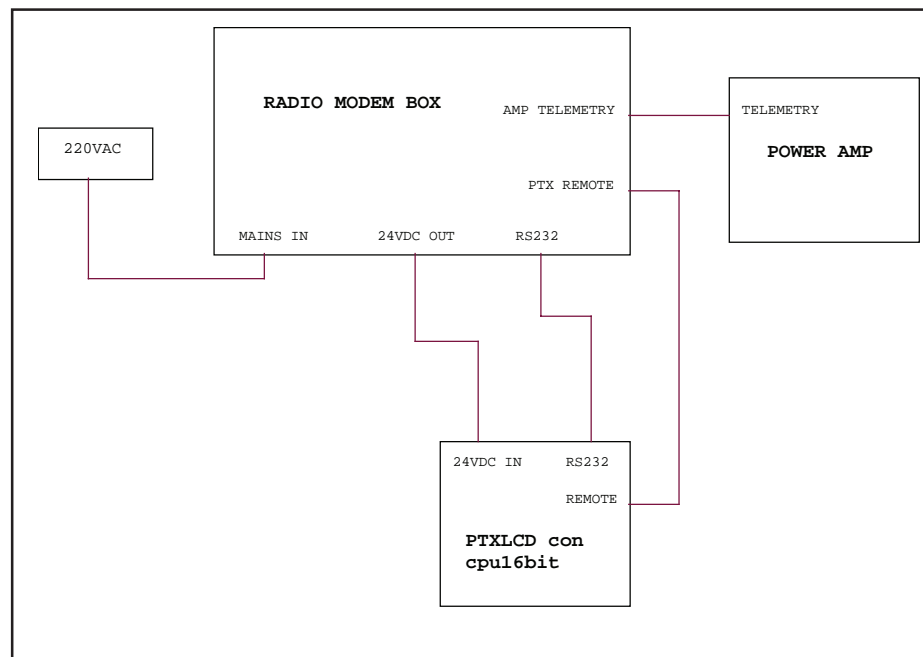

When connected to a system that incorporates a telemetry unit, such as TLC300, it provides backup power, Mains failure signalling and GSM model connection failure signalling.



**WARNING :** Radio Modem Box offers no auxiliary telemetry connection; telemetry control resides on TLC300 or specially designed devices (SCM-TLC family).

Example of connection of version with battery charger to a system with TLC300:

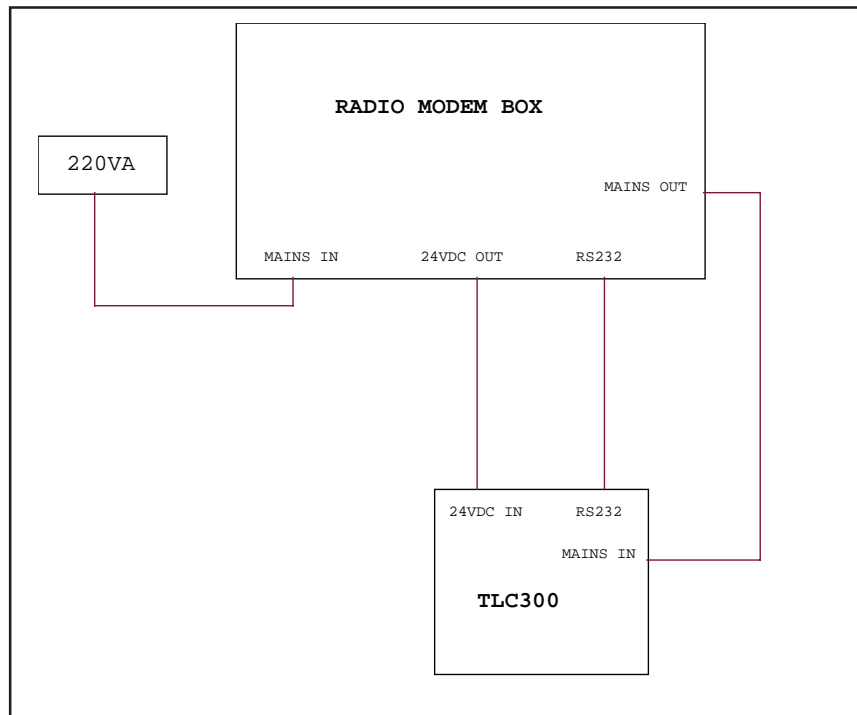

## 5. Quick Guide - Installation and Use

This section provides a sketchy overview of machine installation procedure. If in doubt, especially when using the machine for the first time, read the whole manual carefully.

### 5.1 Preparation

Unpack Radio Modem Box and immediately inspect the device for transport damage. Pay special attention to all connectors and controls on the front and rear panels and ensure they are not damaged.

Connect Radio Modem Box according to one of the configurations described in Section 4.

If you wish to change the type of amplifier connected, or if amplifier type was not specified on order, please refer to table 5.1 for dipswitch SW1 setting (see Main Card wiring diagram).

SW	PJ2000MC PJ1000M (dig. meter) PJ500M-C HC (dig. meter) PJ1000C	PJ1000M (ana. Meter) HC (ana. Meter)	PJ300M PJ501M
1	OFF	ON	ON
2	OFF	ON	ON
3	ON	OFF	OFF
4	ON	OFF	OFF
5	ON	ON	OFF
6	OFF	OFF	ON
7	ON	ON	OFF
8	OFF	OFF	ON

*Table 5.1*

The SIM card to be inserted into Radio Modem Box must be registered for "Data & Fax Service" (see facsimile contract shown in fig. 5.1).

SIM card configuration for DATA/FAX reception must meet the following specifications:

- Asynchronous;
- Transparent;
- 300-9600 Baud.

Maximum connection speed is 9600 baud for transmission over GSM phone line.

**omnitel** **Proposta di Abbonamento per Imprese**

La/i sottoscrittore/i così come sotto identificato/i, propone a Omnitel Pronto Italia S.p.A. di concludere un contratto di abbonamento al servizio telefonico radiomobile GSM secondo gli elenchi di Piano/i Telefonico/i e le condizioni speciali qui di seguito indicati ed in base alle Condizioni Generali di Contratto allegate alla presente che dichiara di conoscere ed accettare.

**Il Codice Cliente** 0315 9999

---

**I Dati dell'Impresa** (vedi "Consigli" per la compilazione)

Denominazione (Ragione Sociale) \_\_\_\_\_ Forma Giuridica \_\_\_\_\_  
(Nome se persona fisica) (Cognome se persona fisica)

P.IVA \_\_\_\_\_ Registro Imprese: Numero \_\_\_\_\_ Anno di iscrizione \_\_\_\_\_ Provincia \_\_\_\_\_

Recapito Telefonico di Rete Fissa \_\_\_\_\_ Contatto Sig./Sig.ra \_\_\_\_\_

Intestatario del Recapito Telefonico di Rete Fissa: \_\_\_\_\_ Forma Giuridica / Cognome \_\_\_\_\_  Privato  Impresa

Domicilio Fiscale (Via, ecc.) \_\_\_\_\_ N° \_\_\_\_\_

Località \_\_\_\_\_ CAP \_\_\_\_\_ Prov. \_\_\_\_\_ Nazione \_\_\_\_\_

Sede Legale \_\_\_\_\_ N° \_\_\_\_\_ Località \_\_\_\_\_ CAP \_\_\_\_\_ Prov. \_\_\_\_\_

Settore  N. Dipendenti \_\_\_\_\_ Cap.soc. \_\_\_\_\_ 000000 Fatturato \_\_\_\_\_ 000000

e-mail \_\_\_\_\_ Numero Fax \_\_\_\_\_

---

**I Dati del Delegato o Legale Rappresentante**

Nome \_\_\_\_\_ Posizione in Azienda \_\_\_\_\_

Cognome \_\_\_\_\_

Documento di Identità  C.I. \_\_\_\_\_ Nazionalità del documento \_\_\_\_\_

**L'Indirizzo di Spedizione del Conto** (diverso dal Domicilio Fiscale)

Indirizzo \_\_\_\_\_ N° \_\_\_\_\_ Località \_\_\_\_\_

c/o \_\_\_\_\_ CAP \_\_\_\_\_ Prov. \_\_\_\_\_

---

**I Piani Telefonici**

Nuovo Personal 195  Le Opzioni

Giorno  Sera  Programma Affari  Opzione Segreteria (escluso Italy)

Italy  Programma Persona  Servizio Dati e Fax (alla velocità di 9.600 bit/sec)

Dippiù 30  Me 95 034  Esclusione del numero telefonico dall'elenco abbonati

Nominativo o numero telefonico non visibili sul display del telefono chiamato

---

**Il Regime Fiscale** (vedi "Consigli" per la compilazione)

Uso familiare del Servizio.  Uso del Servizio per attività economica

Proposta di Contratto Kasko

Resto inteso che in caso di uso familiare del Servizio telefonico radiomobile GSM si applica la normativa fiscale a norma dell'Art. 75 DPR 917/86 nonché la detrazione del 19 DPR 633/72.

---

**La Modalità di Pagamento**

Carta di Credito  Addebito Diretto su Conto Corrente N° \_\_\_\_\_

Banca \_\_\_\_\_ Codice Banca A.B.I. \_\_\_\_\_ C.A.B. \_\_\_\_\_

Indirizzo \_\_\_\_\_ Agenzia \_\_\_\_\_ CAP \_\_\_\_\_ Prov. \_\_\_\_\_

Bollettino Postale

---

**La Carta SIM**

Il Numero di Serie 8 9 3 9 1 0

Il Telefono Cellulare \_\_\_\_\_

IMEI \_\_\_\_\_

E' stato acquistato il telefono con la SIM Omnitel

---

**Le Sottoscrizioni Aggiuntive**

Numero Sottoscrizioni Aggiuntive \_\_\_\_\_

Adesione alla Convenzione Omnitel \_\_\_\_\_

---

**Il Rivenditore Autorizzato**

Codice del Rivenditore \_\_\_\_\_ Nome del Rivenditore \_\_\_\_\_

Timbro e firma del Rivenditore Autorizzato ai fini della corretta identificazione del Proponente e della corretta compilazione della Proposta di Abbonamento. La presente firma non costituisce in alcun caso accettazione della Proposta di Abbonamento da parte di Omnitel.

---

**Il Numero di Telefono** **I Numeri Dati e Fax**

034 \_\_\_\_\_ Il N° Dati 034 \_\_\_\_\_

**Le Condizioni Speciali**

Anticipo sulle Chiamate: Lire \_\_\_\_\_

---

**La Firma della Proposta di Abbonamento**

La firma conferma le obbligazioni del Cliente previste nella presente Proposta di Abbonamento, anche con riferimento alla modalità di pagamento e regime fiscale prescelti. Il contratto tra il Cliente ed Omnitel Pronto Italia S.p.A. si perfeziona in base alla procedura contenuta nell'Art. 2 delle Condizioni Generali di Contratto.

Data \_\_\_\_\_ Il Cliente o Delegato \_\_\_\_\_

---

**La Firma dell'adesione alla Convenzione Omnitel**

La firma conferma la presa visione e l'accettazione delle Condizioni di adesione all'offerta "Convenzione Omnitel".

Data \_\_\_\_\_ Il Cliente o Delegato \_\_\_\_\_

---

**MANIFESTAZIONE DI CONSENSO AL TRATTAMENTO DEI DATI PERSONALI PER PROPOSTA DI ABBONAMENTO**

1) In relazione all'informativa qui dietro riportata, do il consenso al trattamento, diffusione e comunicazione, anche a terzi, dei dati personali ai fini di aggiornamenti su iniziative ed offerte della Società OMNITEL PRONTO ITALIA S.p.A., programmi e promozioni volti a premiare i Clienti, invio di materiale pubblicitario, informazionale e commerciale, ricerche di mercato, analisi economiche e statistiche, che potranno essere eseguite anche attraverso un sistema automatizzato di chiamata senza intervento di un operatore di teleselezione. Inoltre, do il consenso al trattamento dei miei dati di traffico e fatturazione ai fini della commercializzazione di servizi di telecomunicazioni.

Il Cliente o il Delegato (quest'ultimo munito dei relativi poteri) \_\_\_\_\_

2) In relazione all'informativa qui dietro riportata, prevo atto che i dati personali forniti verranno trattati, diffusi e comunicati anche a terzi, anche all'estero per lo svolgimento degli adempimenti relativi alla tutela del rischio del credito, do il consenso alle predette comunicazioni ed ai relativi trattamenti ed autorizzo la comunicazione di tali dati in banche dati finalizzate alla tutela del rischio del credito ed accessibili a terzi, ai quali tali dati potranno quindi essere comunicati. Sono inoltre consapevole che in mancanza del mio consenso al trattamento, alla comunicazione e diffusione di tali dati per la finalità sopraindicata, troverà applicazione la disposizione di cui all'art.6.5 l'Anticipo sulle chiamate" delle Condizioni Generali di contratto.

Il Cliente o il Delegato (quest'ultimo munito dei relativi poteri) \_\_\_\_\_

---

Omnitel Pronto Italia S.p.A. Sede legale: Via Jervis, 13 - 10115 Intra (TO) Imb. Intra n. 3068 Reg. Soc. - COGIA Torino n. 660391

Copia per il Cliente 3

Figura 5.1

Follow the instructions provided below closely to ensure correct configuration of the connection to PTX LCD with 16-bit CPU:

- 1) Open the Radio Modem Box
- 2) Insert the SIM card into the GSM modem (see Fig. 5.2).
- 3) Set dipswitches as required (see table 5.1).
- 4) Close the Radio Modem Box.
- 5) Connect the 220V power supplies.
- 6) Connect the RS232 (DB9) cable across PTXLCD and Radio Modem Box.
- 7) Connect the REMOTE (DB15) cable across PTXLCD and Radio Modem Box.
- 8) Connect the Telemetry (DB25) cable across Radio Modem Box and amplifier (if fitted).
- 9) Connect the red/black cable across PTXLCD and Radio Modem Box jacks; take care to avoid possible short circuits.
- 10) Power on the devices.
- 11) Connect PC and Radio Modem Box using the front panel RS232 DB9 connector.
- 12) Programme the internal EEPROM (refer to PTXLCD manual).
- 13) Before setting the various remote alarm reporting parameters on PTX LCD, ensure it has been placed into "LOCAL" mode, or you will be getting alarm indications during the whole setting procedure (see PTX LCD Manual, Volume 1, Section "Alarm Config").

If the Radio Modem Box is connected to a PTX LCD, alarm time factory settings are as follows:

MAINS: 10 sec  
FWD: 15 sec  
RFL: 15 sec

If the Radio Modem Box is connected to a PTX LCD with external amplifier, alarm time factory settings are as follows:

MAINS: 10 sec  
Ext. FWD: 15 sec  
Ext. RFL: 15 sec

Mains alarm time must always be lower than FWD and RFL time.

When finished, place PTX LCD back into "REMOTE" mode.

- 14) Disconnect the PC connection cable and connect the supplied DB9/DB9 cable.
- 15) Connect the GSM modem antenna to Radio Modem Box connector "N". Use a broadband Yagi log-periodic directional antenna (700-900 MHz).
- 16) Select modem as "GSM" in PTXLCD settings.

Follow the instructions provided below closely to ensure correct configuration of TLC/SCM connection:

- 1) Open the Radio Modem Box.
- 2) Insert the SIM card into the GSM modem (see Fig. 5.2).
- 3) Set dipswitches as required (see tab. 5.1).
- 4) Close the Radio Modem Box.
- 5) Connect the 220V power supplies.
- 6) Connect the RS232 (DB9) cable across the TLC/SCM unit and the Radio Modem Box.
- 7) Connect the red/black cable across the TLC/SCM unit and Radio Modem Box jacks; take care to avoid possible short circuits.
- 8) Power on the devices.
- 9) Connect PC and Radio Modem Box using the front panel RS232 DB9 connector.
- 10) Programme the internal EEPROM (refer to TLC/SCM manual).

- 11) Disconnect the PC connection cable and connect the supplied DB9/DB9 cable.
- 12) Connect the GSM modem antenna to Radio Modem Box connector "N". Use a broadband Yagi log-periodic directional antenna (700-900 MHz).
- 13) Select modem as "GSM" in TLC/SCM settings.

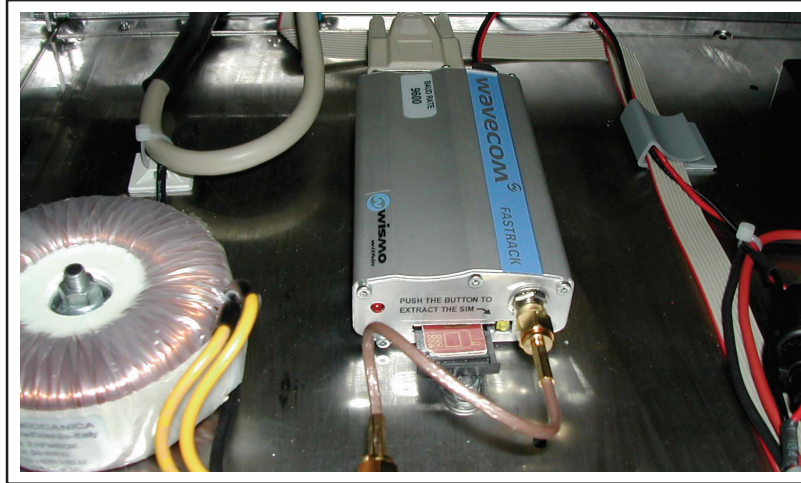

Figure 5.2

## 5.2 Remote Alarm Reporting Configuration

Firstly, you will have to programme certain Radio Modem Box parameters using the "TELECON" software. To this end, connect the PC serial port COM to the RS232 connector on Radio Modem Box front panel using a standard Male DB9 - Female DB9 serial cable.

When using the "TELECON" software for the first time, select the station and then enter:

- COM port used,
- Baud rate (9600),
- type of connection (direct, via cable).

When you have entered the correct data, click the "Start" button to confirm and the "TELECON" main screen appears, as shown in the figure:



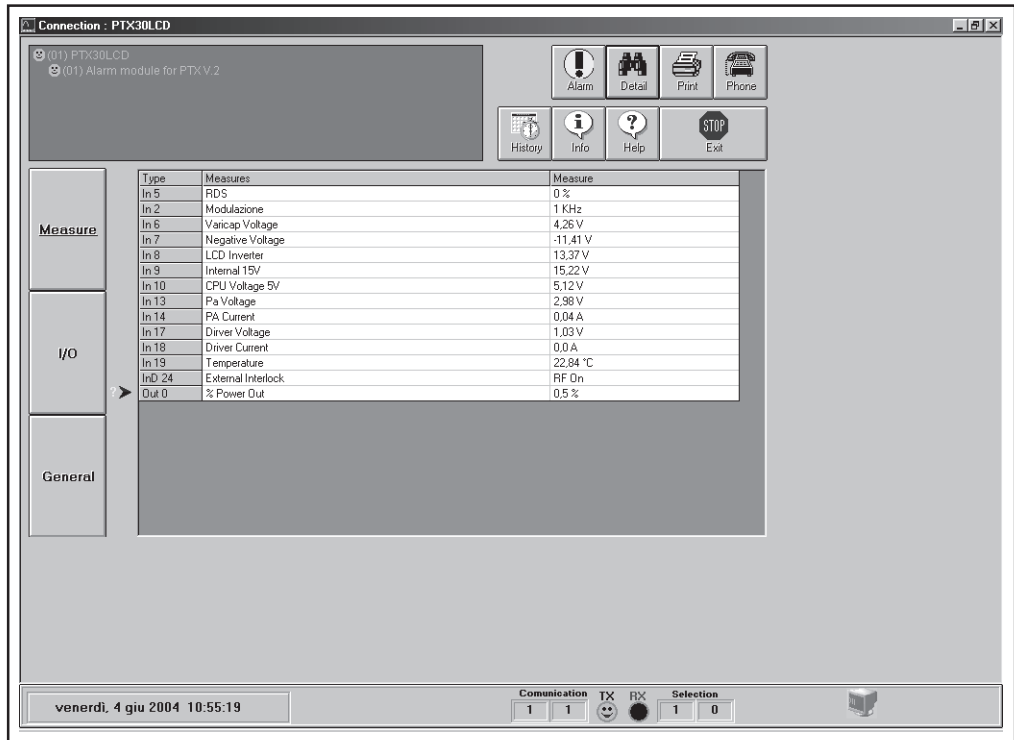

Double click the green label in the top left corner of the TELECON screen and select "Eeprom" (as shown in the next figure).

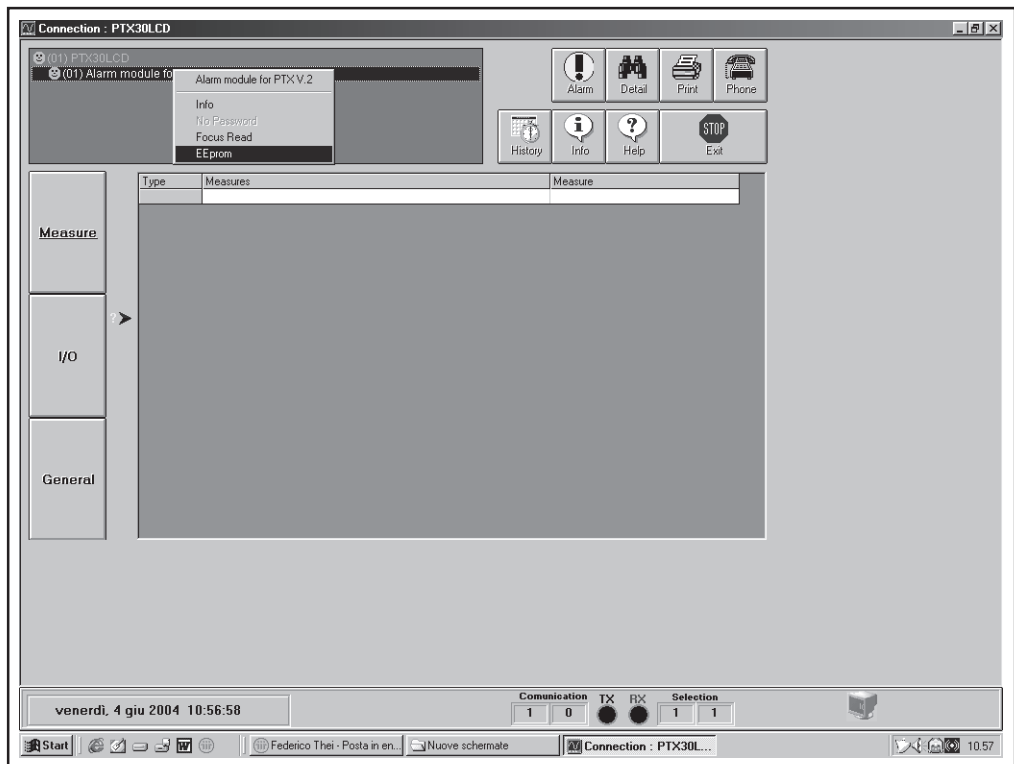



In the open menu, press this key to view station parameters.

Select the "General" data category and set the 5 parameters:

- **STATION ID:** station identifier;
- **STATION NAME:** (max 18 characters);
- **DIAL STRING:** required setting for a GSM modem is ATDT;
- **NUMBER OF RETRY:** number of alarm transmission repetitions;
- **SERVICE CENTER NUMBER:** number of GSM provider service center for SMS transmission and reception; place country code before number.

Example with Italian service providers:

TIM: +393359609600

VODAFONE: +393492000200

WIND: +393205858500

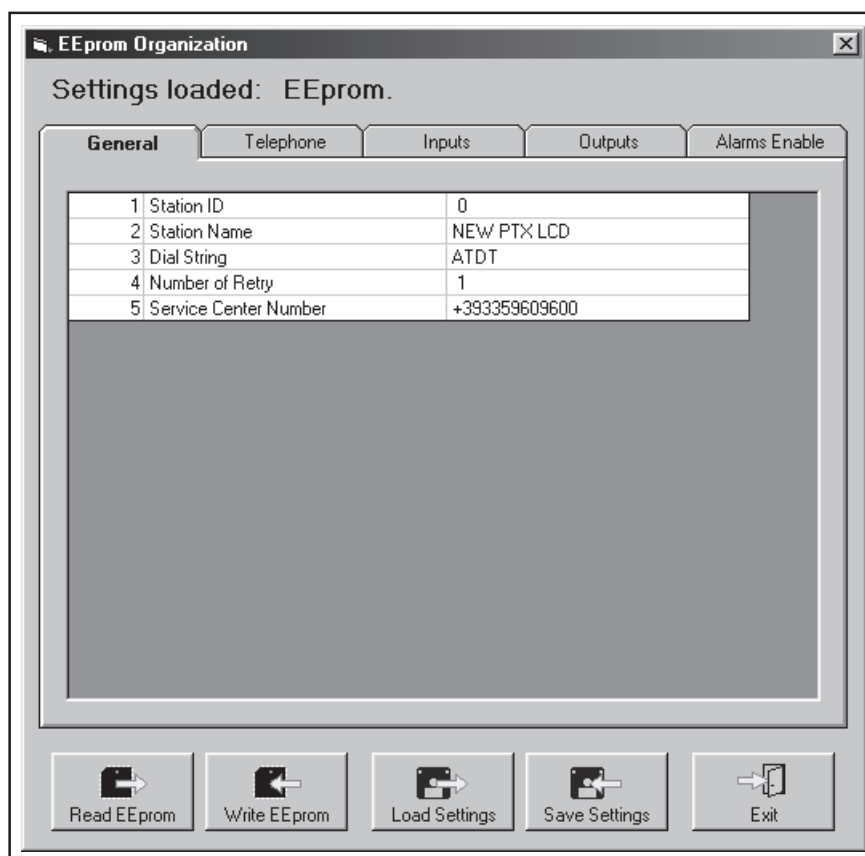

Now select the "Telephone" data category and set the following:

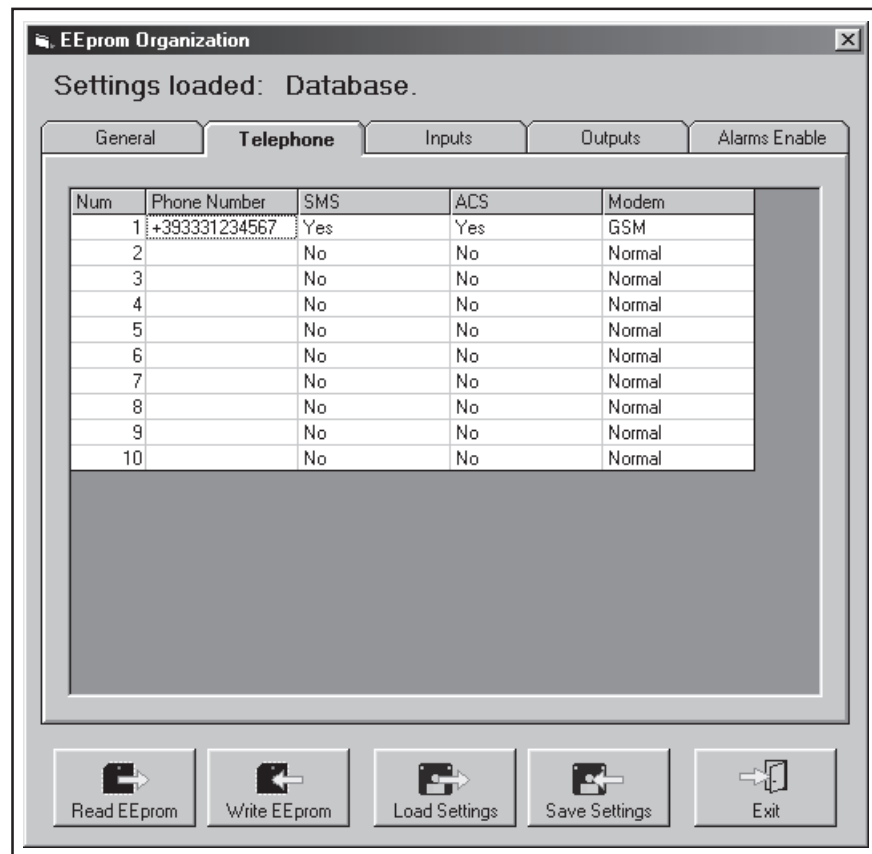

- **PHONE NUMBER:** GSM phone numbers recognised by the station to which you want the alarms sent;
- **SMS:** select "YES" to enable SMS reception;
- **ACS:** select "YES" to enable transmission of SMS commands to system;
- **MODEM:** select "GSM".



**Note:** For correct transmission, place country code (+XX) before set numbers (Use +39 for Italy).

In systems with SCM-TLC or with PTX LCD incorporating the telemetry option, user-programmable alarms are available and are managed by selecting the "INPUTS" data category.

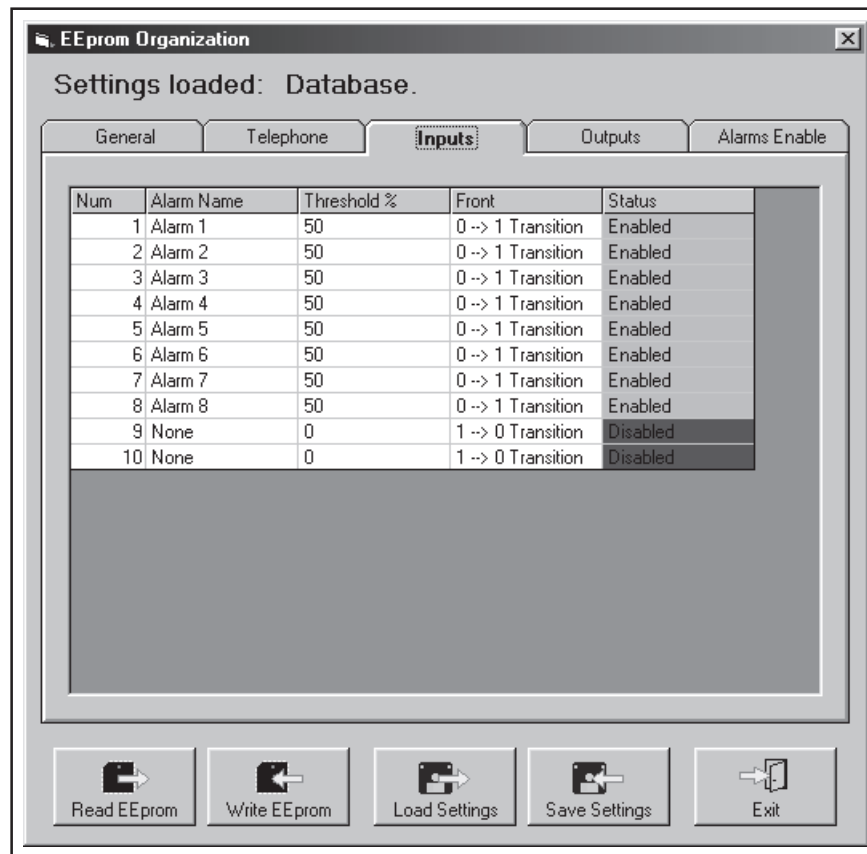

- **ALARM NAME:** Name of alarm sent with SMS (max 20 characters);
- **THRESHOLD:** Alarm activation threshold in percent;
- **FRONT:** **0-->1** Alarm is activated if signal exceeds set threshold;  
**1-->0** Alarm is activated if signal drops below set threshold;
- **STATUS:** **Enable** Alarm enable  
**Disable** Alarm disable



When all parameters are set, press this key and the device connected to Radio Modem Box will store the information.

When finished, click "Exit" to exit the remote station programming window.

Back into "TELECON" standard interface, click the "General" measurement selection button to set thresholds and operation times for the various alarms according to the principles outlined in Section "Alarm Management".



**Note:** When setting alarm thresholds, allow a margin of some percent points with respect to normal operation parameters.

## 5.3 Remote Control

All parameters of the device connected to Radio Modem Box that have been enabled for telemetric control can be monitored on a PC with a suitable modem connection.

The "TELECON" software establishes connection with the station through a phone line or GSM modem and enables the following remote operations: alarm reset, transmitter power on/power off, output power reduction, dummy load testing, etc., data evaluation to locate possible faults, identification of parts required for repair.

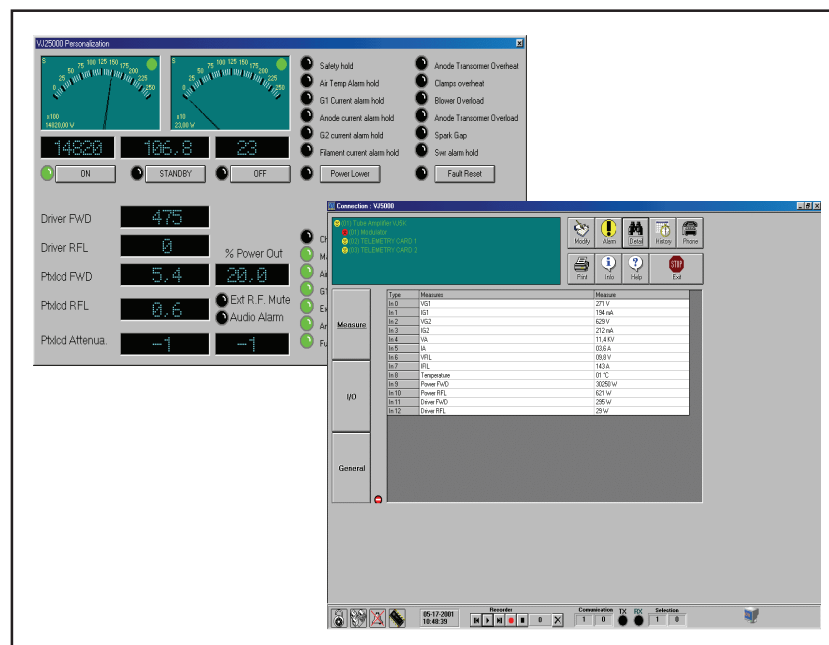

## 5.4 SMS alarm test procedure

This section describes the test procedure for SMS alarms in a system comprising PTX LCD with 16-bit CPU.

Initial configuration:

- 1) Perform the steps described in paragraphs 5.1 and 5.2.
- 2) Go to the "MODEM" menu of PTX LCD and ensure that state is "Stby" and provider details (service centre and name) are correct.
- 3) Go to "TEL N." menu of PTX LCD and ensure that the telephone number set previously is present.
- 4) Ensure that PTX LCD power output is greater than the alarm threshold (e.g.: alarm = 50% , output power > 50%).
- 5) Ensure that PTX LCD display is set in the "MODEM" menu.

Now run a forward power (FWD) alarm test:

- 1) Set a power value lower than the alarm power in PTX LCD (e.g.: <5%)
- 2) Wait longer than the time set in the "ALM ST" menu.
- 3) The "GENERAL" LED on the PTX LCD panel will come on to indicate successful alarm acquisition.
- 4) The wording "TX SMS" appears on PTX LCD display (in the "MODEM" menu).
- 5) Wait for message reception.

If no message is received, double check the configurations of the parameters discussed in paragraphs 5.1 and 5.2 and repeat the alarm test procedure.

Now run a mains failure alarm test.

- 1) Remove power supply from PTX LCD and Radio Modem Box at the same time.
- 2) PTX LCD will restart on 24V with the "Ext RF Mute" LED on.
- 3) Wait for a time period equal to "start" time (60 sec) added with the time set in the "ALM ST" menu.
- 4) The "GENERAL" LED on the PTXLCD panel will come on to indicate successful alarm acquisition.
- 5) The wording "TX SMS" appears on PTX LCD display (in the "MODEM" menu).
- 6) Wait until message "MAINS = absent" is received.
- 7) Wait for PTX LCD shut down triggered by Radio Modem Box time-out.
- 8) Put power back to the system (PTX LCD + Radio Modem Box).
- 9) The "GENERAL" LED on the PTX LCD panel is off to indicate that no alarm condition is present.
- 10) Wait for a time period equal to "start" time (60 sec).
- 11) The wording "TX SMS" appears on PTX LCD display (in the "MODEM" menu).
- 12) Wait until message "MAINS = present" is received.

If no message is received, double check the configurations of the parameters discussed in paragraphs 5.1 and 5.2 and repeat the alarm test procedure.

Listed below are the factory settings for the different PTX LCD alarms in a system equipped with Radio Modem Box.



**Note:** Setting delay time to 0 (zero) disables the alarm.

PTX LCD stand alone

Alarmi name	Threshold	Delay time in sec. (0 = disabled)
FWD	50%	15
RFL	50%	15
External FWD	50%	0
External RFL	50%	0
Audio	-	10
Mains	-	10

START time (can only be set via RS232) = 60 seconds

## PTX LCD with amplifier

Alarm name	Threshold	Delay time in seconds (0 = disabled)
FWD	50%	0
RFL	50%	0
External FWD	50%	15
External RFL	50%	15
Audio	-	10
Mains	-	10

START time (can only be set via RS232) = 60 seconds



### Note on audio alarm:

Delay time (10 sec.) is an arbitrary value, as the alarm depends on the width of sent audio signal.

Normally, PTXLCD will go into a "NOAUDIO" state after audio signal has been missing for about 5 minutes; if the problem persists after the delay time has elapsed (if greater than zero), the alarm is triggered.

A missing audio signal is a signal generating a modulation lower than 15KHz.



### Note on alarm thresholds:

All alarm thresholds are based on the maximum value the machine will allow.

Example:

PTX30LCD	FWD 100% = 30W	RFL 100% = 3W
PTX100LCD	FWD 100% = 100W	RFL 100% = 10W

PTX30LCD+PJ1000 Ext.FWD 100% = 1000W Ext.RFL 100% = 100W

PTX30LCD+PJ2000 Ext.FWD 100% = 2000W Ext.RFL 100% = 200W

This means that a 50% setting in FWD or in Ext.FWD will trigger an alarm when power DROPS below 50% of MAXIMUM output, NOT of current setting.

Likewise, a 50% setting in RFL or in Ext.RFL will trigger an alarm when power RISES above 50% of the MAXIMUM value allowed.

### Alarm conditions

	50% FWD	50% RFL
PTX30LCD	< 15W	> 1,5W
PTX100LCD	< 50W	> 5W
	50% Ext.FWD	50% Ext.RFL
PTX30LCD+PJ1000	< 500W	> 50W
PTX30LCD+PJ2000	< 1000W	> 100W

## 6. Controls, Modules and Connectors

This Section provides a description of the front and rear panels of Radio Modem Box, with a brief outline of the different element functions, machine blocks as well as connector types and pinouts.

### 6.1 Front Panel

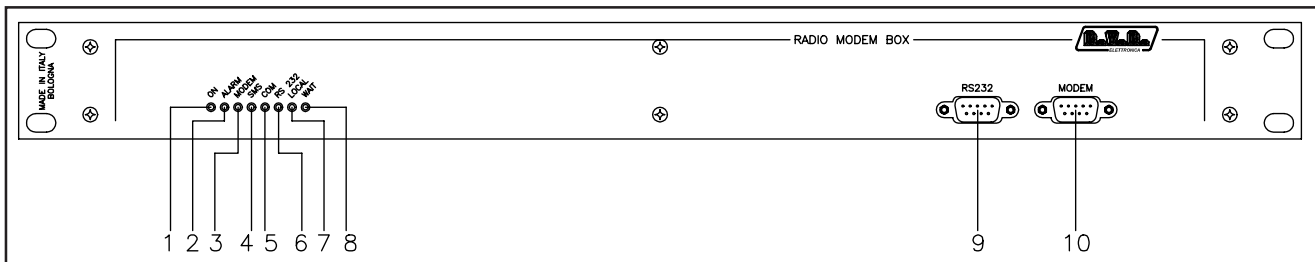

Figure 6.1

[1] ON	N.C. (Provided for future expansion).
[2] ALARM	N.C. (Provided for future expansion).
[3] MODEM	N.C. (Provided for future expansion).
[4] DISPLAY	N.C. (Provided for future expansion).
[5] SMS	N.C. (Provided for future expansion).
[6] COM	N.C. (Provided for future expansion).
[7] RS 232	N.C. (Provided for future expansion).
[8] LOCAL	N.C. (Provided for future expansion).
[9] RS 232	DB9 connector connected to telemetry unit (PTX LCD/SCM-TLC <-> PC).
[10] MODEM	connector connected to GSM Modem (PC <-> Radio Modem Box).

### 6.2 Rear Panel

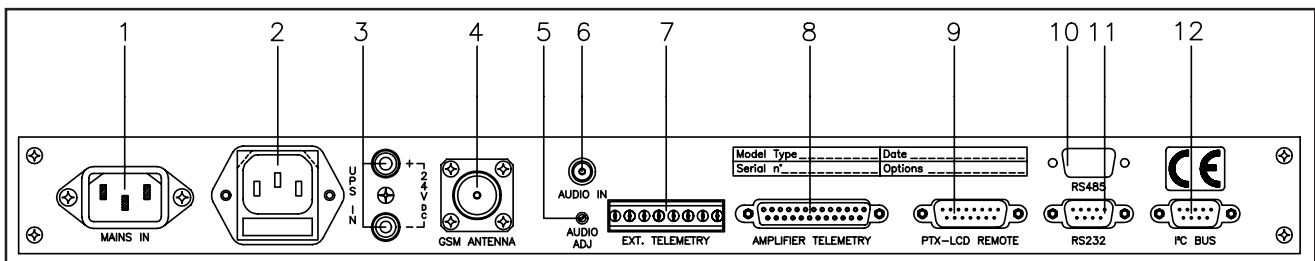

Figure 6.2

[1] MAINS IN	MAINS IN VDE mains power supply connector.
[2] UPS IN	VDE connector for UPS input with two 1-A fuses (not fitted to version with battery charger)



[3] 24V DC	(Red - black) jacks for 24V DC output (not fitted to version with UPS).
[4] GSM ANTENNA	N-type connector for antenna connection.
[5] AUDIO ADJ	Trimmer for audio input level adjustment.
[6] AUDIO IN	Audio input female jack connector.
[7] EXT. TELEMETRY	Terminal board for telemetry connection to third-party amplifiers (other than R.V.R. Elettronica units).
[8] TELEMETRY AMPL.	DB25 connector for telemetry connection to R.V.R. Elettronica amplifiers.
[9] PTX-LCD REMOTE	DB15 connector for telemetry connection to PTX LCD
[10] RS 485	N.C. (Provided for future expansion).
[11] RS 232	DB9 connector for communication interface to external devices.
[12] I <sup>2</sup> C BUS	DB9 connector for I <sup>2</sup> C communication.

## 6.3 Module identification (top view)

Radio Modem Box with battery charger



Figura 6.3

[1] MAIN CARD	Mains card SLINTBOXGSM1.
[2] BATTERY	Set of two 12V 2,1AH lead batteries.
[3] MODEM	Wavecom GSM modem.
[4] TRANSFORMER	30VA transformer.
[5] ANTENNA FILTER	GSM filter band.

## Radio Modem Box with UPS

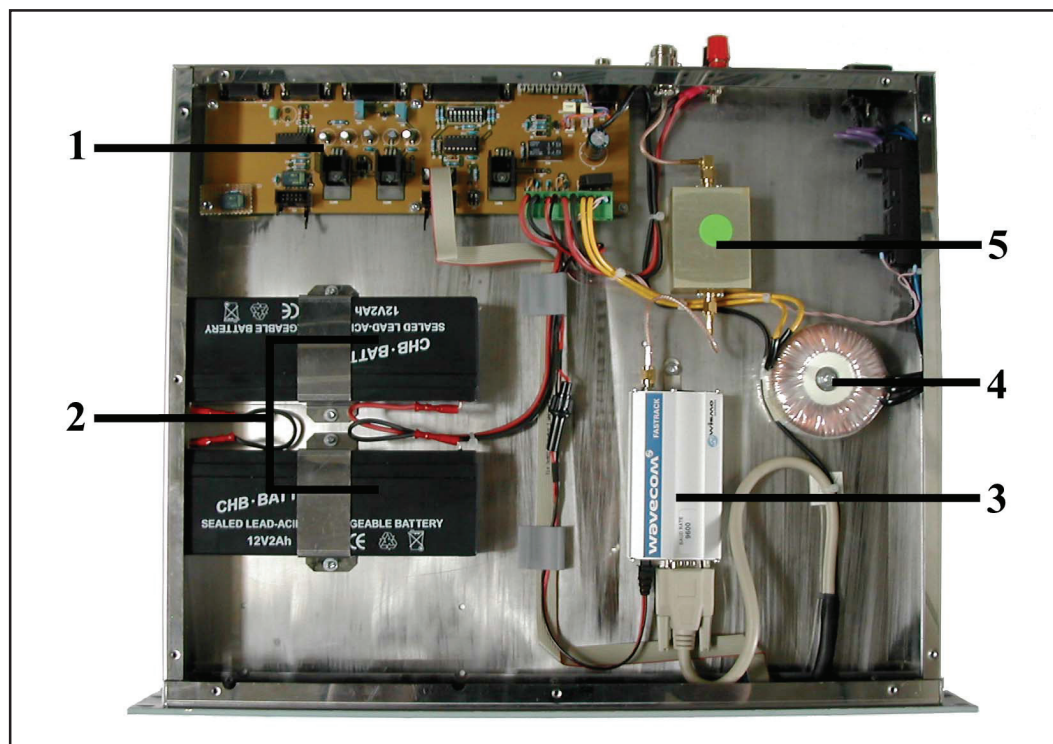
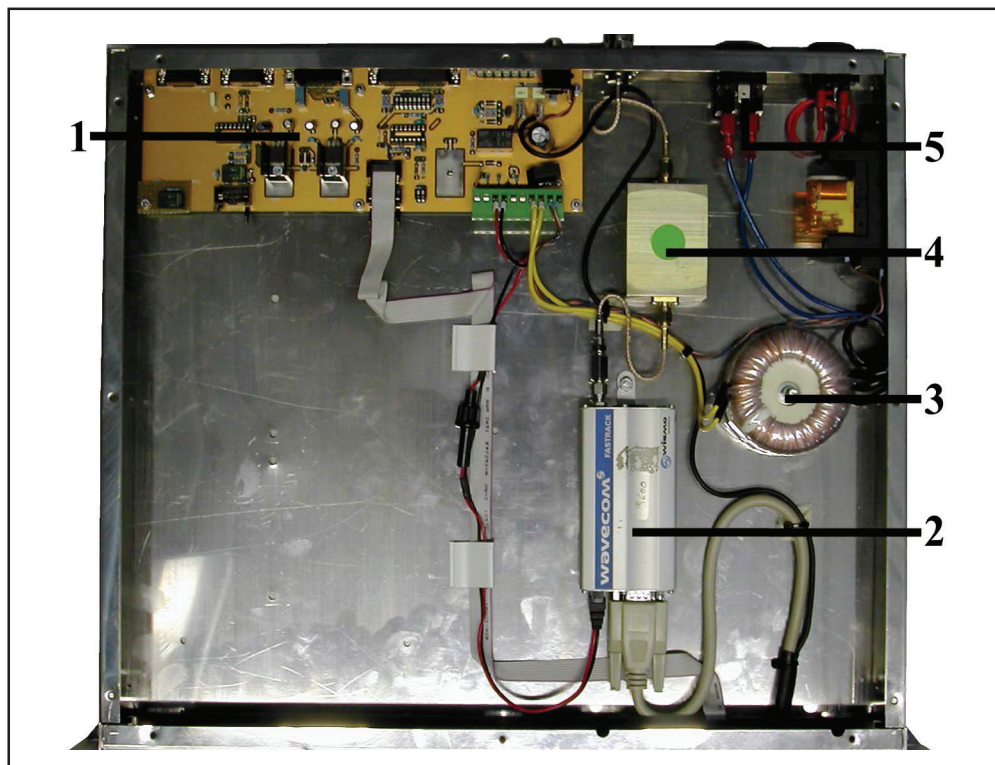

Figure 6.2

[1] MAIN CARD	Mains card SLINTBOXGSM1.
[2] MODEM	Wavecom GSM modem.
[3] TRANSFORMER	30VA transformer.
[4] ANTENNA FILTER	GSM band filter.
[5] UPS IN	VDE Connector for UPS input, incorporates two 1-A fuses.

## 6.4 Connector Pinouts

All connectors supplied with Radio Modem Box as standard for connection to other devices are of the Pin-to-Pin type.

### 6.4.1 Telemetry connector

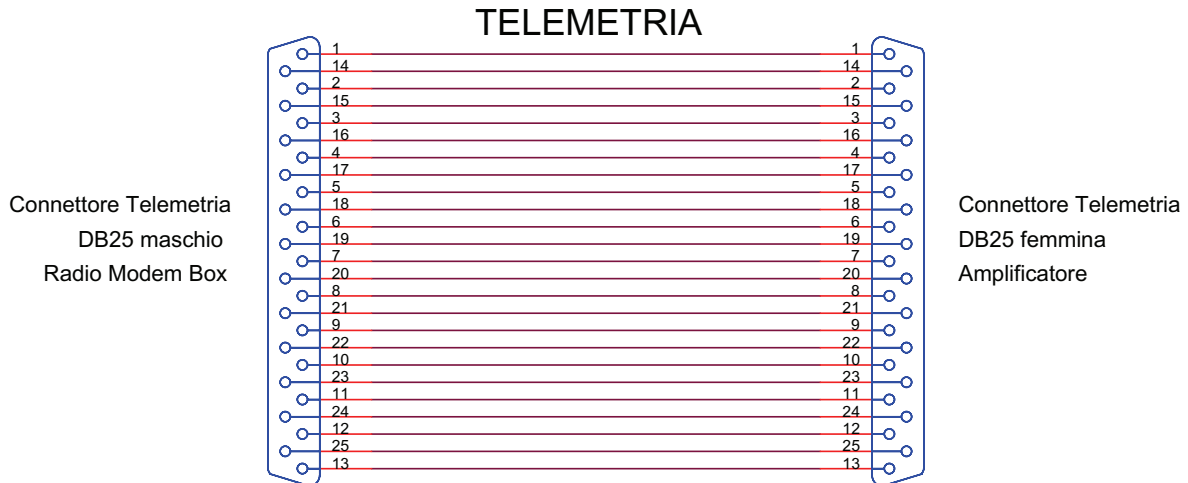

Type: DB25 Male

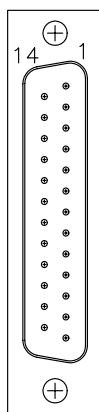

1	VPA	Ana In	with Dip5 OFF, Dip6 ON
2	VPA	Ana In	with Dip5 ON, Dip6 OFF
3	IPA	Ana In	with Dip7 OFF, Dip8 ON
4	GND	GND	
5	Rfl Pwr T	Ana In	Reflected Power
6	IN_EXC T	Dig In OC	Active in the event of exciter interlock
7	N.C.		
8	OC_ON T	Dig Out	Command "ON"
9	N.C.		
10	N.C.		
11	N.C.		
12	N.C.		
13	N.C.		
14	N.C.		
15	IPA	Ana In	with Dip7 ON and Dip8 OFF
16	FWD PWR T	Ana In	Forward Power
17	TEMPALARM	Dig In	Dip3 OFF, Dip3 ON with R Pullup
18	SWRALARM	Dig In	Dip4 OFF, Dip4 ON with R Pullup
19	INP_PWR AMP	Dig In	Input Power
20	OFF CMD	Dig Out	Command "OFF"
21	N.C.		
22	N.C.		
23	N.C.		
24	VNS T	+12 VDC	Not stabilised
25	N.C.		

#### Notes:

The signal available at PINs 2, 17, 18 may vary depending on the configuration of switch SW1.

## 6.4.2 RS232 connector

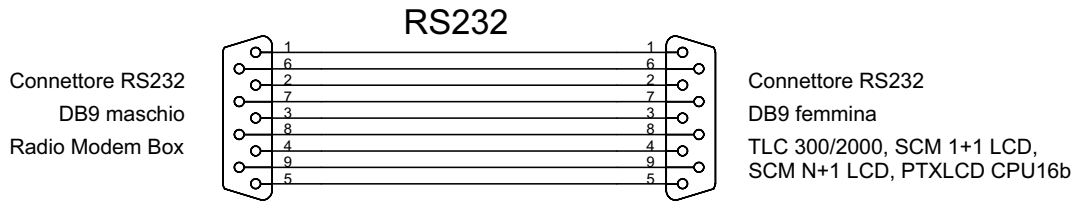

Type: DB9 Male

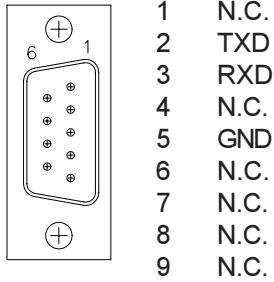

## 6.4.3 I<sup>2</sup>C Connector

Type: DB9 Male

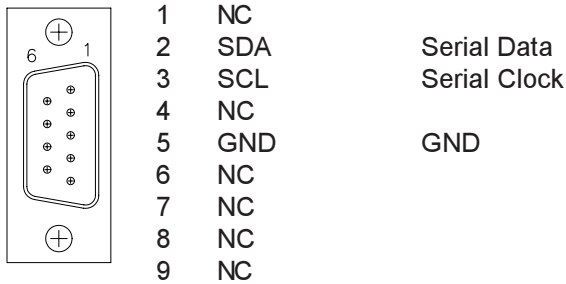

## 6.4.4 Ext. Telemetry

Type: 8 Pin terminal board



1	FWD PWR	IN
2	RFL PWR	IN
3	VPA	IN
4	IPA	IN
5	TEMP ALARM	IN
6	SWR ALARM	IN
7	MAINS ALARM	OUT
8	GND	

### Notes:

Pin 7 will output 0 V if an alarm signal is present on Mains.

## 7. Electric diagram, layout and bill of materials

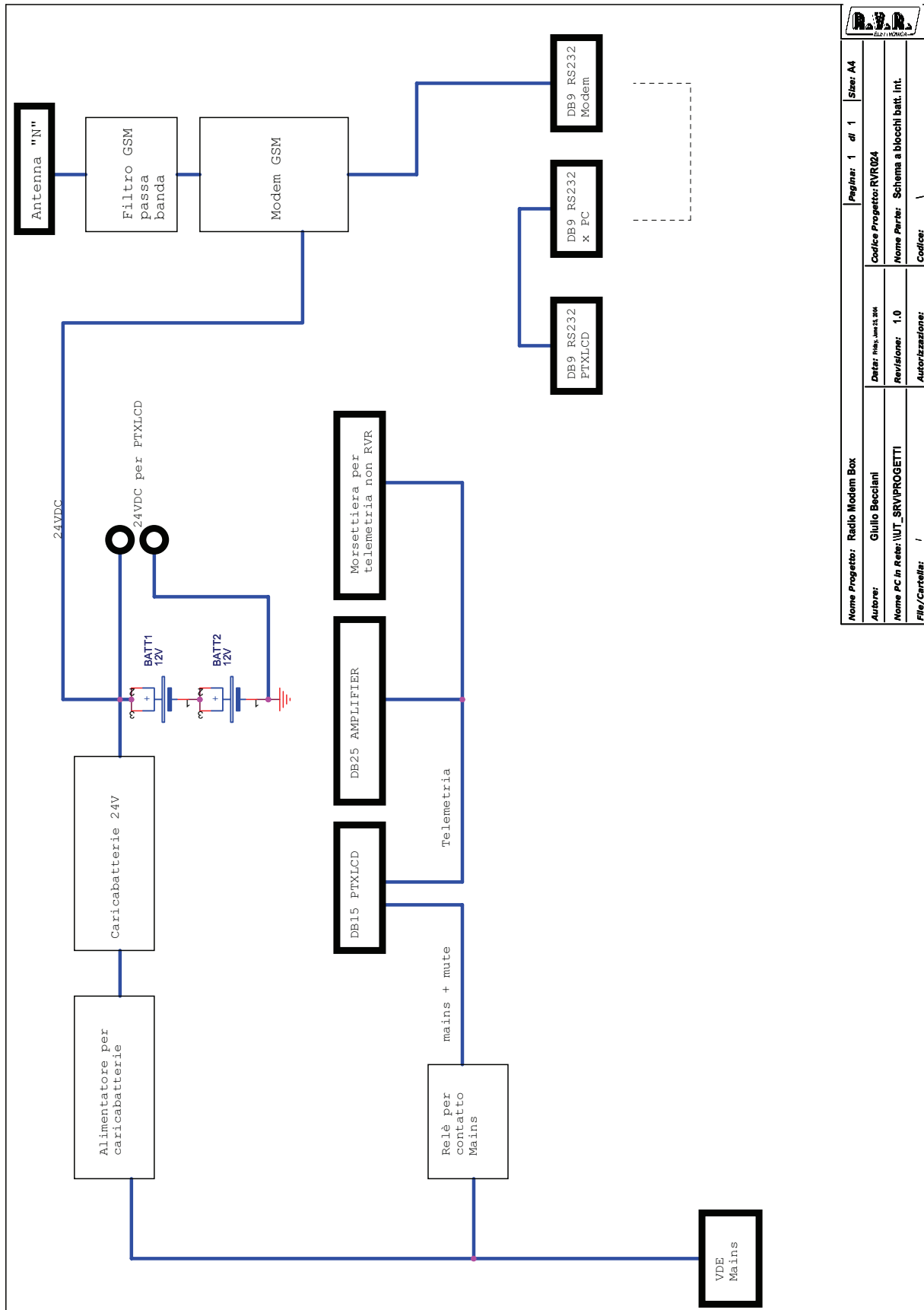

Nome Progetto: Radio Modem Box		Pagina: 1	di 1	Size: A4
Autore: Giulio Becciani		Codice Progetto: RVR024		
Nome PC in Rete: \UT_SRVPROGETTI		Data: 16/06/04	Nome Parte: Schema a blocchi batt. int.	
File/Cartella: /		Revisione: 1.0	Codice:	
		Autorizzazione:		

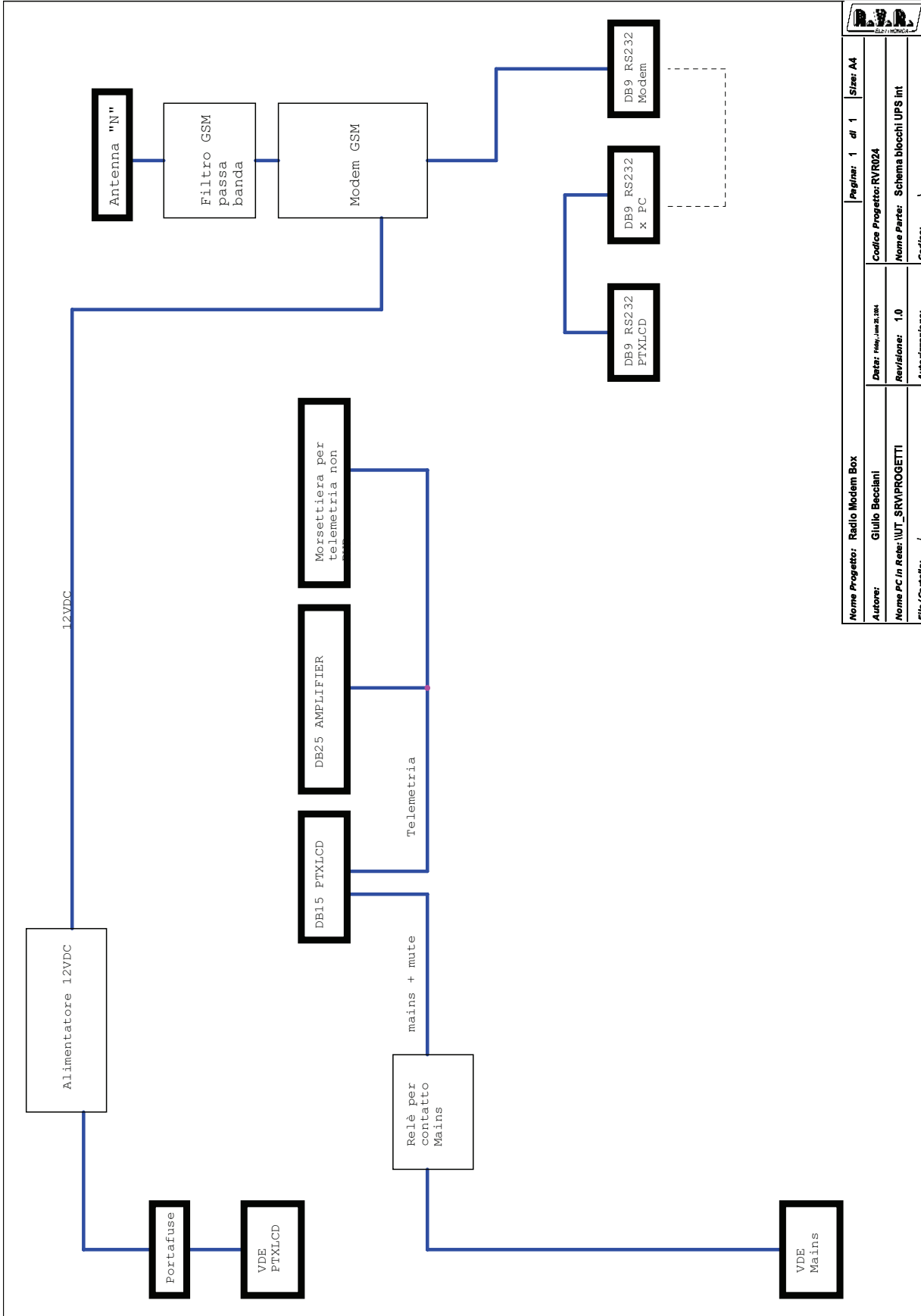

Nome Progetto: Radio Modem Box		Pagina: 1 di 1	Size: A4
Autore: Giulio Becciani	Codice Progetto: RVR024		
Nome PC In Rete: \UT_SRVPROGETTI	Data: 14/04/2004	Revisione: 1.0	Nome Parte: Schema blocchi UPS int
File/Cartella: /	Autorizzatore:		Codice:

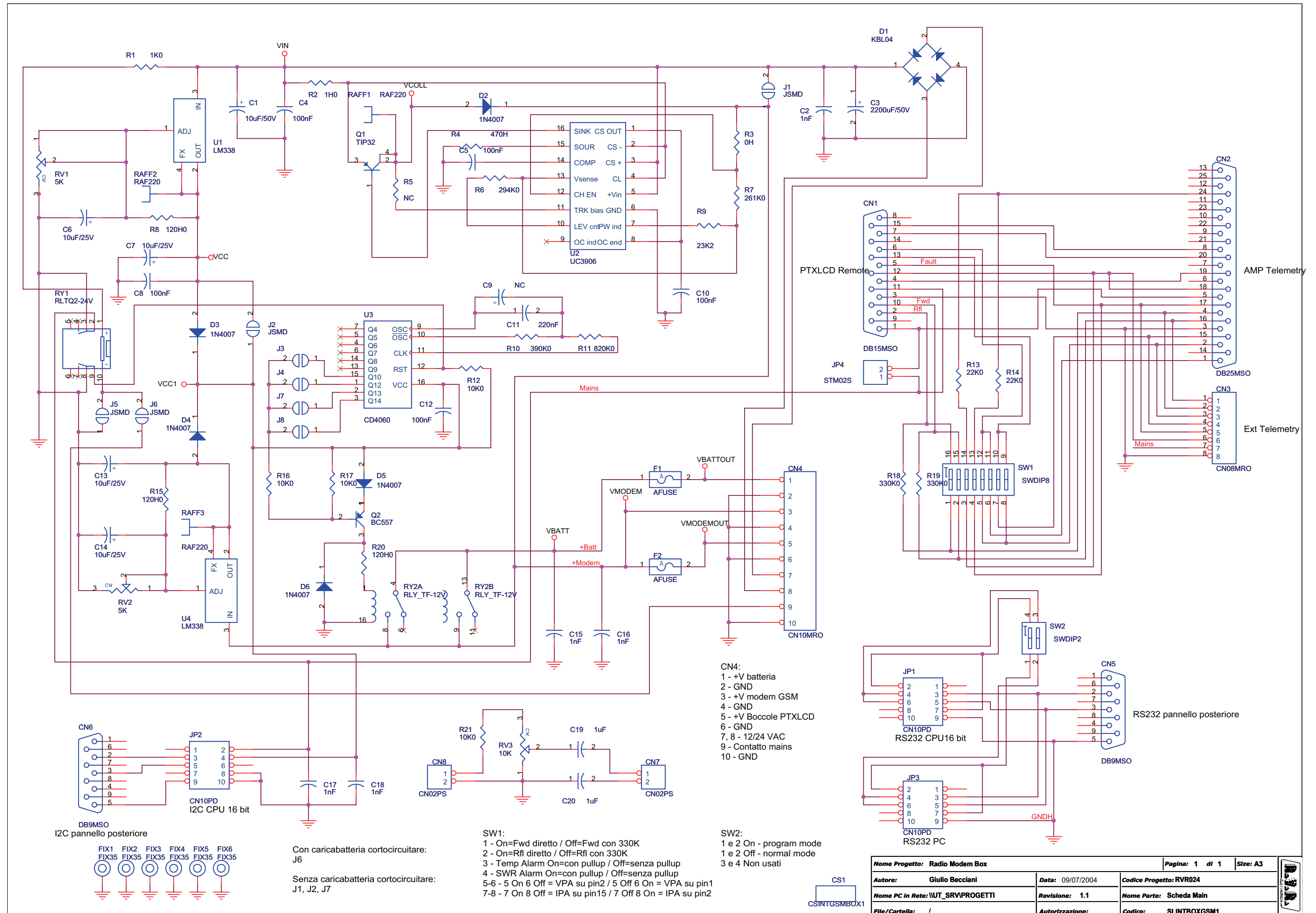

Nome Progetto: Radio Modem Box		Pagina: 1 di 1		Size: A3	
Autore: Giulio Becciani	Data: 09/07/2004	Codice Progetto: RVR024			
Nome PC in Rete: \UT_SRV\PROGETTI	Revisione: 1.1	Nome Parte: Scheda Main			
File/Cartella: /	Autorizzazione:	Codice: SLINTBOXGSM1			

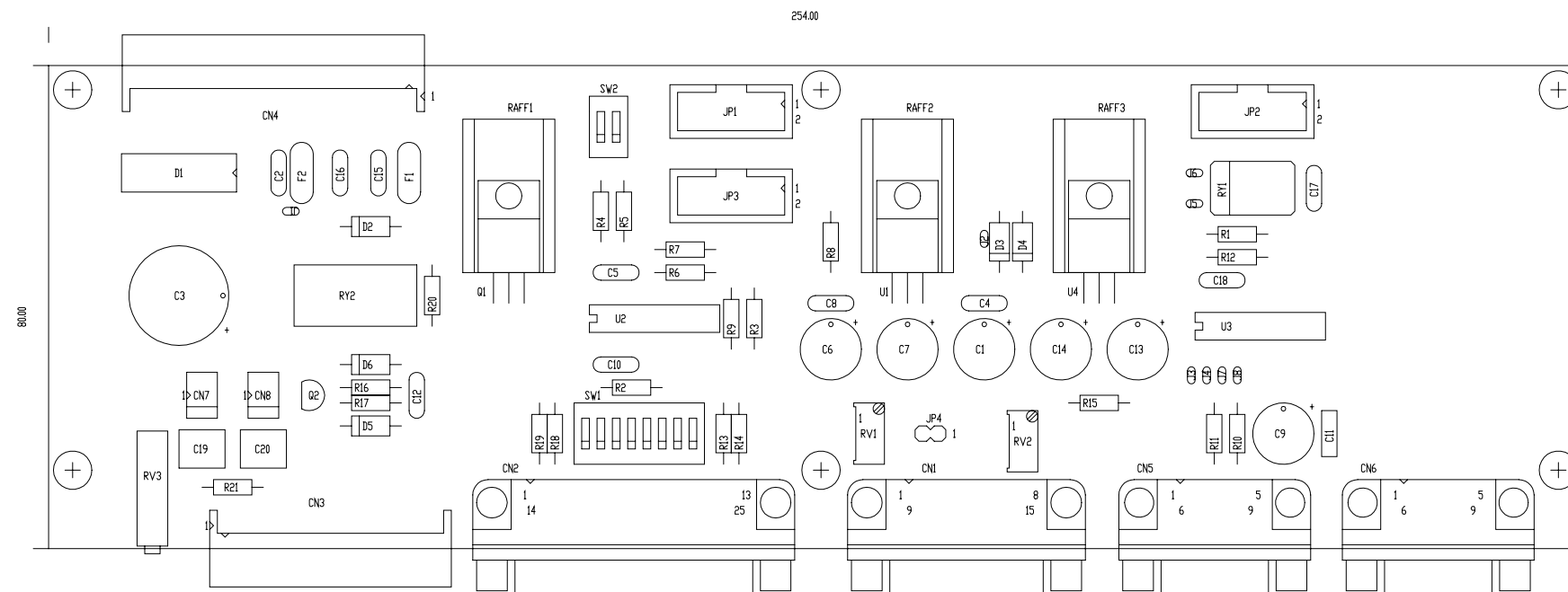

	NOME PROGETTO: RADIO MODEM BOX	NOME PARTE: SCHEDA MAIN
	AUTORE: GIULIO BECCIANI	DATA: 24/06/2004
ARCHIVIAZIONE ELETTRONICA: "CARTELLA PROGETTI" SU "UT_SRV"	CODICE PROGETTO: 024	REVISIONE: 1.0   SCALA: 1:1   SIZE: A3   PAGINA: 1 DI 1
MATERIALE: <>	TRATTAMENTO: <>	PROFILO: <>   STATO: ESECUTIVO



Radio Modem Box - RVR024  
 Scheda Main - SLINTBOXGSM1  
 Rev.: 1.1 - Date: 09/07/2004

Item	Q.ty	Reference	Part	Description
1	1	CN1	DB15MSO	Connettore DB15 mas. cs 90°
2	1	CN2	DB25MSO	Connettore DB25 mas. cs 90°
3	1	CN3	CN08MRO	Connettore KB 90° p. 5mm 8 pin
4	1	CN4	CN10MRO	Connettore KB 90° p. 5mm 10 pin
5	2	CN5, CN6	DB9MSO	Connettore DB9 mas. cs 90°
6	2	CN7, CN8	CN02PS	Connettore 2 poli Panduit
7	1	CS1	CSINTGSMBOX1	Circuito stampato
8	1	C1	10uF/50V	Cond. Elettr. Dia 10 P5.08
9	5	C2, C15, C16, C17, C18	1nF	Cond. ceramico multistrato p 5mm
10	1	C3	2200uF/50V	Cond. Elettr. Dia 16 P7.62
11	5	C4, C5, C8, C10, C12	100nF	Cond. ceramico multistrato p 5mm
12	4	C6, C7, C13, C14	10uF/25V	Cond. Elettr. Dia 10 P5.08
13	1	C9	NC	Cond. Elettr. Dia 10 P5.08
14	1	C11	220nF	Cond. Poliestere p 5mm
15	2	C19, C20	1uF	Cond. Poliestere p 5mm (5*7mm)
16	1	D1	KBL04	Ponte diodi KBL/KBU
17	5	D2, D3, D4, D5, D6	1N4007	Diodo plastico DO41
18	6	FIX1, FIX2, FIX3, FIX4, FIX5, FIX6	FIX35	Foro fissaggio 3.5mm
19	2	F1, F2	AFUSE	Fusibile autorip. 7mm
20	3	JP1, JP2, JP3	CN10PD	Connettore 10 poli Flat cs
21	1	JP4	STM02S	Strip maschio 2 pin
22	8	J1, J2, J3, J4, J5, J6, J7, J8	JSMD	Pad SMD a saldare
23	1	Q1	TIP32	Trans. PNP TO220
24	1	Q2	BC557	Trans. PNP TO92
25	3	RAFF1, RAFF2, RAFF3	RAF220	Dissipatore TO220
26	2	RV1, RV2	5K	Trimmer Rg V 3296W
27	1	RV3	10K	Trimmer Rg H 3006
28	1	RY1	RLTQ2-24V	Rele' TQ2
29	1	RY2	RLY_TF-12V	Rele' serie Feme TF
30	1	R1	1K0	Res. 1/4W 1%
31	1	R2	1H0	Res. 1/4W 1%
32	1	R3	0H	Res. 1/4W 1%
33	1	R4	470H	Res. 1/4W 1%
34	1	R5	NC	Res. 1/4W 1%
35	1	R6	294K0	Res. 1/4W 1%
36	1	R7	261K0	Res. 1/4W 1%
37	3	R8, R15, R20	120H0	Res. 1/4W 1%
38	1	R9	23K2	Res. 1/4W 1%
39	1	R10	390K0	Res. 1/4W 1%
40	1	R11	820K0	Res. 1/4W 1%
41	4	R12, R16, R17, R21	10K0	Res. 1/4W 1%
42	2	R13, R14	22K0	Res. 1/4W 1%
43	2	R18, R19	330K0	Res. 1/4W 1%
44	1	SW1	SWDIP8	Dip switch 8 vie
45	1	SW2	SWDIP2	Dip switch 2 vie
46	2	U1, U4	LM338	Stab. regolabile TO220
47	1	U2	UC3906	Controllo carica batt. PB
48	1	U3	CD4060	14 bit ripple counter w/osc

*Pagina lasciata intenzionalmente in bianco*