

# TECHNICAL AND MAINTENANCE MANUAL

## VJ10000-TE (4CX12000)

### 10Kw Power Tetrode Amplifier 87.5 - 108 MHz



Manufactured by R.V.R. Elettronica - Italy

## INDEX

<b>I - PRELIMINARY INSTRUCTIONS AND WARRANTY INFORMATION.....</b>	<b>4</b>
<b>II - TUBE WARRANTY INSTRUCTIONS.....</b>	<b>6</b>
<b>III – SAFETY REGULAMENT! .....</b>	<b>8</b>
<b>CHAPTER 1.....</b>	<b>12</b>
TX10000-TE GENERAL DESCRIPTION .....	12
1.1) <i>TRANSMITTER DESCRIPTION</i> .....	12
1.2) <i>ELECTRICAL DESCRIPTION</i> .....	12
<b>CHAPTER 2.....</b>	<b>19</b>
ELECTRICAL DESCRIPTION .....	19
2.1 <i>INTRODUCTION</i> .....	19
2.2 <i>CONSIDERATIONS ON WORKING PARAMETERS</i> .....	19
2.3 <i>TUBE</i> .....	20
2.4 <i>R.F. CAVITY</i> .....	20
<b>CHAPTER 3.....</b>	<b>36</b>
INSTALLATION .....	36
3.1 <i>INTRODUCTION</i> .....	36
3.2 <i>UNPACKING</i> .....	36
3.3 <i>ASSEMBLY DESCRIPTION</i> .....	36
3.4 <i>ASSEMBLY PROCEDURES FOR THE INSTALLATION OF VJ1000-TE</i> .....	36
3.5 <i>TRANSMITTER CONNECTION TO MAINS VOLTAGE</i> .....	37
3.5 <i>TUBE INSTALLATION</i> .....	38
3.7 <i>TUNING AND SWITCH ON PROCEDURES</i> .....	39
<b>CHAPTER 4.....</b>	<b>46</b>
MAINTENANCE .....	46
4.1 <i>SAFETY REQUIREMENTS</i> .....	46
MAINTENANCE LEVEL 1 .....	46
4.2 <i>ROUTINE MAINTENANCE</i> .....	46
MAINTENANCE LEVEL 2 .....	46
4.3 <i>MODULE REPLACEMENT</i> .....	46
4.4 <i>TUBE REPLACEMENT</i> .....	47
4.5 <i>AIR FILTER REPLACEMENT</i> .....	47
<b>APPENDIX A.....</b>	<b>47</b>
CIRCUIT DIAGRAMS, LAYOUTS AND BILLS OF MATERIAL .....	47

## PICTURES

FIG. 1 FRONT VIEW DESCRIPTION .....	23
FIG. 2 FRONT VIEW .....	24
FIG. 3 REAR VIEW .....	25
FIG. 4 TOP VIEW DESCRIPTION .....	28
FIG. 5 PROTECTIONS CARD DESCRIPTION .....	29
FIG. 6 R.F. CAVITY'S FRONT VIEW DESCRIPTION .....	30
FIG. 7 WATTMETER VIEW DESCRIPTION .....	31
FIG. 8 R.F. CAVITY LEFT SIDE VIEW DESCRIPTION .....	32
FIG. 9 VOLTAGE STABILIZER DESCRIPTION .....	33
FIG. 10 R.F. CAVITY'S REAR VIEW DESCRIPTION .....	34
FIG. 11 DETAIL REFERENCE .....	35
FIG. 12 TUBE INSTALLATION DIAGRAM N°1 .....	41
FIG. 13 TUBE INSTALLATION DIAGRAM N°2 .....	42
FIG. 14 TUBE INSTALLATION DIAGRAM N°3 .....	44
FIG. 15 I/O RACK CONNECTORS .....	48
FIG. 16 I/O RACK CONNECTORS .....	49
FIG. 17 REFERENCE VIEW .....	50
FIG. 18 R.F. CIRCUIT .....	51
FIG. 19 MEASURE CARD .....	52
FIG. 20 380V CIRCUIT .....	53
FIG. 21 LOW TENSION CIRCUIT .....	54
FIG. 22 MEASURE, ALLARMS, LOW-TENSION CIRCUIT .....	54
FIG. 23 POWER RELAY CARD .....	55
FIG. 24 REFERENCES VIEW .....	56
FIG. 25 INTERFACE TELEMETRY CARD .....	57
FIG. 26 TUNINGS RELAY CARD .....	58
FIG. 27 REFERENCES VIEW .....	59
FIG. 28 POWER SUPPLY P1 .....	60
FIG. 29 SECTIONAL VIEW OF THE POWER SUPPLY P1 .....	61
FIG. 30 POWER SUPPLY P2 .....	62
FIG. 31 SECTIONAL VIEW OF THE POWER SUPPLY P2 .....	63
FIG. 32 PROTECTIONS PLANE .....	64
FIG. 33 REFERENCE VIEW .....	65
FIG. 34 RESISTORS PLANE .....	66
FIG. 35 RESISTORS PLANE .....	67
FIG. 36 REFERENCE VIEW .....	68
FIG. 37 TUNING MOTOR LOAD .....	69
FIG. 38 REFERENCE VIEW .....	70
FIG. 39 RHEOSTATS .....	71
FIG. 40 REFERENCE VIEW .....	72
FIG. 41 PJ1000 PROTECTION SWITCH - PROTECTION FUSES .....	73
FIG. 42 REFERENCE VIEW .....	74
FIG. 43 INPUT SOCKET .....	75
FIG. 44 REFERENCE VIEW .....	76
FIG. 45 UTILITIES SOCKET .....	77
FIG. 46 REFERENCE VIEW .....	77
FIG. 47 HIGHT TENSION PANEL .....	78

## TABLES

TABLE A ELECTRICAL CHARACTERISTICS .....	14
TABLE B MECHANICAL AND ENVIROMENTAL CHARACTERISTICS .....	15
TABLE C TRANSMITTER LIMITS .....	15
TABLE D READABLE PARAMETERS ON THE FRONT METER PANEL .....	16
TABLE E READABLE PARAMETERS ON THE FRONT METER PANEL .....	17
TABLE F PROJECT STRUCTURE SPECIFICATIONS .....	18
TABLE G SPECIFICATION OF THE 4CX20000C TUBE .....	22

## I - PRELIMINARY INSTRUCTIONS AND WARRANTY INFORMATION

Please observe safety precautions when handling this unit. This equipment contains dangerous currents and high voltages.

This manual is written as a general guide for those having previous knowledge and experience with this kind of equipment. It is not intended to contain a complete statement of all safety warnings which should be observed by personnel in using this or other electronic equipment.

**R.V.R.** doesn't assume responsibility for injury or damage resulting from improper procedures or practices by untrained/unqualified personnel in the handling of this unit.

Please observe all local codes and fire protection standards in the operations of this unit.

**CAUTION:** always disconnect power before opening covers or removing any part of this unit. Use appropriate grounding procedures to short out capacitors and high voltage points before servicing.

Any damage to the goods must be reported to the carrier in writing on the shipment receipt. Any discrepancy or damage discovered subsequent to delivery, shall be reported to **R.V.R.** within five (5) days from its receipt.

**R.V.R.** extends to the original end-user purchaser all original manufacturers warranties which are transferable and all claims are to be made directly to **R.V.R.** per indicated procedures.

All manufacturers warranties will be supported by **R.V.R.** to ensure precise and speedy service where possible.

**R.V.R.** shall not be liable for any damage of whatsoever nature, arising out of or in connection with the product or its use thereof.

**R.V.R.**'s warranty shall not include:

- a. Re-shipment of the unit to **R.V.R.** for repair purposes
- b. Any unauthorized repair/modification
- c. Incidental/consequential damages as a result of any defect
- d. Nominal non-incident defects
- e. Re-shipment costs or insurance of the unit or replacement units/parts

Warranty shall come into force from invoice date and for the period of the manufactures warranty.

To claim your rights under this warranty:

- a. Contact the dealer or distributor where you purchased the unit. Describe the problem and ask if he has an easy solution. Dealers and Distributors are supplied with all the information about problems that may occur and usually they can repair the unit quicker than what the manufacturer could do. Very often installing errors are discovered by dealers.
- b. If your dealer cannot help you, contact **R.V.R.** in Bologna and explain the problem. If it is decided to return the unit to the factory, **R.V.R.** will mail you a regular authorization with all the necessary instructions to send back the goods.
- c. When you receive the authorization, you can return the unit. Pack it carefully for the shipment, preferably using the original packing and seal the package perfectly. The customer always assumes the risks of loss(i.e., **R.V.R.** is never responsible for damage or loss), until the package reaches **R.V.R.** premises. For this reason, we suggest you to insure the goods for the whole value. Shipment must be effected C.I.F. (PREPAID) to the address specified by **R.V.R.**'s service manager on the authorization.

**DO NOT RETURN UNITS WITHOUT OUR AUTHORIZATION AS THEY WILL BE REFUSED.**

Be sure to enclose a written technical report where mention all the problems found and a copy of your original invoice establishing the starting date of the warranty.

Replacement and warranty parts may be order from the following address. Be sure to include the equipment model and serial number as well as part description and part number.

**R.V.R. Elettronica S.p.a.** - Broadcasting Equipment -  
Via del Fonditore, 2/2c  
Zona Roveri  
40138 Bologna - Italy  
International Phone: +39 - 51 - 6010506  
FAX Number: +39 - 51 - 6011104

**R.V.R.** reserves the right to modify the design and specifications of the equipment in this manual without previous

## II - TUBE WARRANTY INSTRUCTIONS

### VARIAN POWER GRID PRODUCT LIMITED WARRANTY

Varian products are warranted to be free from defects in workmanship and materials only. The warranty involves both calendar time and filament (or heater) operation time. Specifically involved are: time since the product was shipped from varian time since delivery to the user, and operation time.

WHICHEVER ELAPSES FIRST CONCLUDES THE WARRANTY.

The warranties are determined by the codes shown in the price schedule.

	TIME SINCE SHIPMENT	TIME SINCE SHIPMENT	TIME SINCE HEATER-ON
Code	from EIMAC	To The User	Time
T	36 MONTHS	24 MONTHS	10.000 HOURS
R	24 MONTHS	12 MONTHS	5.000 HOURS
P	24 MONTHS	12 MONTHS	4.000 HOURS
N	24 MONTHS	12 MONTHS	3.000 HOURS
K	24 MONTHS	12 MONTHS	1.000 HOURS
L	LIFE TESTED AT FACTORY IN LIEU OF AN OTHER WARRANTY		
12	24 MONTHS	12 MONTHS	

he last category is for hardware or accessory items whwre only calendar time is involved.

An Original Equipment Manufacturer (OEM) or an authorized Varian Distributor can hold an item in his stock for 12 months and the end user still receiver full warranty. As an example, warranty code T is for 36 months from the date of the shipment from EIMAC, or 24 months from the date of delivery to the user,or 10.000 hours of filament-on time, whichever elapses first.

A product which fails (because of faulty workmanship or materials) in the first 10% of the warranty-time hours will be heither replaced at no charge by Varian or 100% of the purchase price will be credited through the original authorized Varian Distributor or OEM. If a failure occurs in the remaining 10-100% of the warranty time hours a prorated adjustment will be calculated and credit issued. This can only be done through the original OEM or authorized Varian Distributor

A prorated credit is calculated as follows:

$$\frac{\text{Warranty (hours)} - \text{Use Time (hours)}}{\text{Warranty (hours)}} = \% \text{ Credit}$$

Thus for failure Code N (3000 hours) if failure occurred after 600 hours and was found to be workmanship or materials related:

$$\frac{3000 - 600}{3000} = 80\%$$

Tubes being returned on a warranty claim are normally sent to authorized Varian distributor or OEM from whom originally purchased. If returned directly to the Varian plant of manufacture, the authorized Varian Distributor or OEM from whom purchased should be notified in case there are some special instructions.

All products returned on a warranty claim must be shipped via prepaid freight and include a completed copy of a service report form, a copy of which is included with every shipped product. A warranty claim cannot be processed without this form. A copy of the original invoice, bill of sale, or other purchase document should be included with the executed service report form to establish purchase date and price.

The original Varian shipping carton and packing material should always be used for any warranty claim return. Shipping damage because of poor packing will normally preclude any warranty adjustment since the damage will usually make any testing or measurements impossible.

PARCEL POST SHOULD NEVER BE USED FOR SHIPMENT OF TUBES.

### **III – SAFETY REGULAMENT!**

#### **WARNING!**

The currents and voltages in this equipment are dangerous! Personnel must at all times observe safety regulation!.

This manual is intended as a general guide for trained and qualified personnel who are aware of the dangers inherent in handling potentially hazardous electrical and electronic circuits.

It is not intended to contain a complete statement of all safety precautions which should be observed by personnel in using this or other electronic equipment.

The installation, operation, maintenance and service of this equipment involves risks both to personnel and equipment, and must be performed only by qualified personnel exercising due care.

**R.V.R. ELETTRONICA s.p.a.** shall not be responsible for injury or damage resulting from improper procedures or from the use of improperly trained or inexperienced personnel performing such tasks.

During installation and operation of this equipment, local building codes and fire protection standards must be observed.

#### **WARNING!**

Always disconnect power before opening covers, doors, enclosures, gates, panels or shields.

Always use grounding sticks and short out high voltage points before servicing. never make internal adjustments, perform maintenance or service when alone or when fatigued.

Do not remove, short-circuit or tamper with interlock switches on access covers, doors, enclosures, gates, panels or shields.

Keep away from live circuits, know your equipment and don't take chances.

#### **WARNING!**

In case of emergency ensure that power has been disconnected.



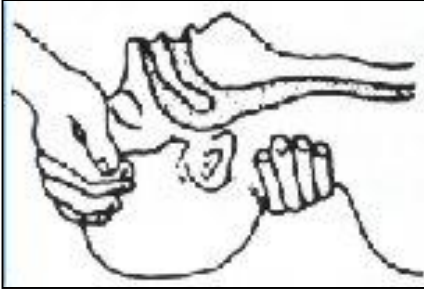
## TREATMET OF ELECTRICAL SHOCK

1) If victim is not responsive follow the A-B-C's of basic life support.

### PLACE VICTIM FLAT ON HIS BACK ON A HARD SURFACE

#### A) *AIRWAY*

IF UNCONSCIOUS,  
OPEN AIRWAY



LIFT UP NECK, PUSH,  
FOREHEAD BACK,  
CLEAR OUT MOUTH IF  
NECESSARY, OBSERVE  
FOR BREATHING.

#### B) *BREATHING*

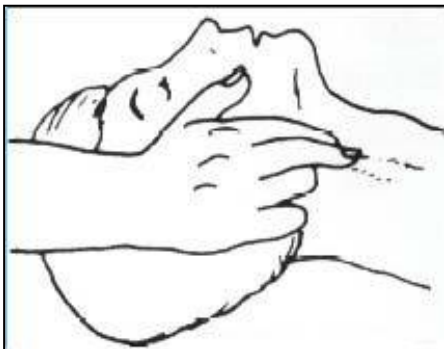
IF NOT BREATHING, BEGIN  
ARTIFICIAL BREATHING



TILT HEAD PINCH NOSTRILS, MAKE  
AIRTIGHT SEAL, 4 QUICK FULL  
BREATHS. REMEMBER MOUTH TO  
MOUTH RESUSCITATION MUST BE  
COMMENCED AS SOON AS POSSIBLE.

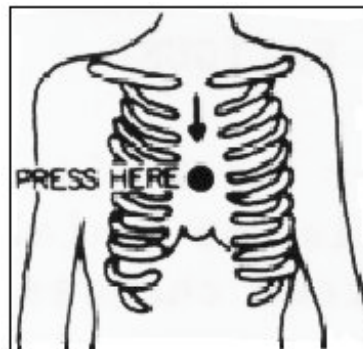
#### C) *CIRCULATION*

CHECK CAROTID PULSE



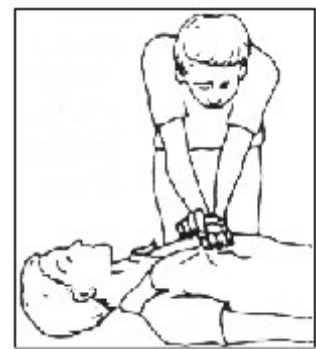
IF PULSE ABSENT, BEGIN  
ARTIFICIAL CIRCULATION

DEPRESS STERNUM 1 1/2" TO 2"



APPROX. 80 SEC. : ONE RESCUER, 15 COMPRESSIONS,  
2 QUICK BREATHS.

APPROX. 60 SEC. : TWO RESCUERS, 5 COMPRESSIONS,  
1 BREATH



**NOTE: DO NOT INTERRUPT RHYTHM OF COMPRESSION WHEN SECOND PERSON IS GIVING BREATH.**

**Call for medical assistance as soon as possible.**

2) If victim is responsive:

- a. Keep them warm.
- b. Keep them as quiet as possible.
- c. Loosen their clothing (a reclining position is recommended).

## FIRST-AID

Personnel engaged in the installation, operation, maintenance or servicing of this equipment are urged to become familiar with first-aid theory and practices. The following information is not intended to be a complete first-aid procedure, it is brief and is only to be used as a reference. It is the duty of all personnel using the equipment to be prepared to give adequate Emergency First Aid and thereby prevent avoidable loss of life.

### Treatment of electrical Burns

#### 1) Extensive burned and broken skin.

- a. Cover area with clean sheet or cloth.  
(Cleanest available cloth article).
- b. Do not break blisters, remove tissue, remove adhered particles of clothing, or apply any salve or ointment.
- c. Treat victim for shock as required.
- d. Arrange transportation to a hospital as quickly as possible
- e. If arms or legs are affected keep them elevated.

### NOTE

If medical help will not be available within an hour and the victim is conscious and not vomiting, give him a weak solution of salt and soda: 1 level teaspoonful of salt and 1/2 level teaspoonful of baking soda to each quart of water (neither hot or cold). Allow victim to sip slowly about 4 ounces (half a glass) over a period of 15 minutes. Discontinue fluid if vomiting occurs (Do not give alcohol).

#### 2) Less severe burns - (1st & 2nd degree)

- a. Apply cool (not ice cold) compresses using the cleanest available cloth article.
- b. Do not break blisters, remove tissue, remove adhered particles of clothing, or apply salve or ointment.
- c. Apply clean dry dressing if necessary.
- d. Treat victim for shock as required.
- e. Arrange transportation to a hospital as quickly as possible.
- f. If arms or legs are affected keep them elevated.



# CHAPTER 1

## TX10000-TE GENERAL DESCRIPTION

### 1.1) TRANSMITTER DESCRIPTION

The TX10000-TE/V1 is an FM broadcast transmitter working in the frequency band from 87.5 MHz to 108 MHz. The transmitter is composed of a modulator (mono or stereo) mod. PTX30LCD, a driver amplifier mod. PJ1000M and a tetrode final amplifier mod. VJ10000-TE for the antenna connection.

The transmitter is composed of two 19" racks, 40 HE each, mechanically and electrically connected together, so that, when the installation is completed, to realize a single functional equipment that shows on the right side the driver amplifier, the modulator and the power supply and service section for final stage amplifier, and on the left side shows the final amplifier cavity and the general air cooling section.

The final power amplifier uses the tetrode 4CX12000A grounded grids configured with cathode excitation.

### 1.2) ELECTRICAL DESCRIPTION

The VJ10000 is a tube amplifier with utilize the tetrode 4CX12000A grounded grids configured with cathode excitation.

This amplifier is able to operate with several output max power values but inferior to 27 Kw continuous with a driver power of about 1000W.

The amplifier show plate pipes, load and input motorised, allowing coverage of the entire frequency band.

The VJ10000 has been designed to use a 3-phase supply (3-phase option without neutral).

### 1.3) FRONT PANEL DESCRIPTION

The working parameters values and commands are available separately on each equipment.

About the description of the modulator and driver amplifier see as reference its manual issued to the transmitter; in fact, these equipment are autonomous and they are only contained in the complete transmitter rack.

About the final power amplifier are available the readings of the following working parameters:

- A) forward and reflected output power on a single meter, selectable by a selector placed on the itself meter;
- B) control and screen grid currents on a single meter, selectable by a selector placed on the itself meter;
- C) plate current;
- D) plate voltage, control grid voltage, screen voltage, filament voltage and filament current on a single multimeter, selectable by a totative selector placed on the itself multimeter;
- E) output cavity air temperature and number of the protection interventions on a alpha-numeric display at double two digits;
- F) indication with the working hours of the tetrode filament on hour counter;
- G) active alarm led indications (red color) relative to anomalies caused to excessive plate, control grid and screen grid currents, excessive reflected power, insufficient control grid voltage, plate voltage enabled but not present, insufficient air pression in the cavity, excessive air temperature on the output cavity;
- H) INTERLOCK led indicator to indicate the block of the equipment caused to personnel safety.

- I) led indicators as memory of the protection interventions happened (yellow color);
- J) led indicator to indicate the voluntary protections service stand-by for short time for a final amplifier overload.
- K) led indicator to indicate the voluntary plate power supply stand-by.

The commands relative the final power stage amplifier are the followings

- A) key selector to enable the tunings push buttons;
- B) two push-buttons at three positions that allow the setting of the input tuning of the tetrode amplifier cavity;
- C) a push-button at three positions that allows the setting of the frequency tuning of the tetrode amplifier cavity;
- D) a push-button at three positions that allows the setting of the working impedance of the tetrode anode;
- E) a selector at two positions that allows to put in stand-by the tetrode anode power supply;
- F) a selector at six positions to select the different measures of the multimeter;
- G) a selector at two positions that allows to select the control grid or screen grid current measures;
- H) a selector at two positions that allows to select the forward and reflected power measures;
- I) a key selectro that allows to put in stand-by for a short time the overload protections of some amplifier's parameters;
- J) a push-button that allows to reset the counting and the memories of the protections interventions occurred;
- K) a push-button that allows to change on the display the indication from protection interventions counter to status of the warm-up timer;
- L) a main switch with overload protection that allows to stop the mains voltage to all service circuits of the amplifier.

Please refer to Table A for the electrical specifications and Table B for the mechanical specifications.

#### 1.4) PANNEL ALARMS

The panel alarms (fig.2) has numbers indicators of different colors: the red leds point out a condition of current alarm, the yellow leds show that there has been a condition of alarm then reentered.

This encircled is characterized by the following protections: excess of VSWR, excess grid current, excess of anodic current, insufficient power tension, excess of temperature, opening panel, insufficient ventilation and a key interrupter.

On the panel there are two interrupters, one visualizing the preheating time of valve filament the second reading the number of reset cycles that the circuit protection has performed.

Finally a digital display with four digits show the time or the n° of cycles (the two digits of left), the air temperature of expulsion (°C) (the two digits of right).

Prese, refer to the TABLE A for electrical charcterostocs and the TABLE B for enviromental specifications.

**TABLE A ELECTRICAL CHARACTERISTICS**

Power Supply	3-phase with neutral: 380-415V±15% 3-phase without neutral: 208-240V±15%
Manins Voltage Frequency	50-60 Hz
Frequency Range	87.5 - 108 MHz
Tube	4CX12000A
Electrical power consumption for 10Kw in antenna	22KVA
External Thermal power consumption for 10Kw in antenna	7Kw
Cosφ	0.9
Correct power consumption for phase	32%,32%,36%
Output Power	from 500 to 10000W
Antenna Impedance	50 Ohm
No essential emessions	less than -85dBc
Frequency Stability	2.5 ppm
Modulation Type	F3E
Preenphasis	50 o 75 micro-seconds selectable
Modulation S/N ratio	82 dB (rms value, dev=±75Khz)
AM synchronous	-47dB (mod=400Hz, dev=±75Khz)
AM asynchronous	-47dB
Audio MPX input impedance	600 or 1000 Ohm
Audio Channel input impedance	600 or 1000 Ohm
Input audio level	fron -13 to +14dB (adjustable)
Channel frequency response	from 30 to 15000Hz
Channel distorsion	max 0.07% (from 30 to 15000Hz)
Stereo separation	greater than 50 dB
Input for SCA or RDS signal	n°3
Air cooling	Forced ventilation

**TABLE B MECHANICAL AND ENVIROMENTAL CHARACTERISTICS**

Rack dimensions	565 mm (22.24") W 850 mm (33.46") D 1930 mm (75.98") H
Working temperature	from -5° to +45°C
Maximum installation admissible	max 95% to 45°C without condensing
Maximum installation height	2500 m
Cooling air volume	3000 m3/h

**TABLE C TRANSMITTER LIMITS**

Standard tetrode time life=9000 hours at 10KW (maxim 12000 hours)
Power efficiency that depends from the antenna system quality SWR<1.15
Good aspiration air for cooling without impurities
Maintenance aspiration air filters =3 mounths
Very high working noise.

**TABLE D READABLE PARAMETERS ON THE FRONT METER PANEL**

Output forward power  
Output reflected power  
Tetrode anode current  
Tetrode screen grid current  
Tetrode anode voltage  
Tetrode filament voltage  
Tetrode screen grid voltage  
Tetrode control grid voltage  
Tetrode driver power  
Reflected power of the tetrode input circuit  
Power supply current of the solid state PA stage  
Power supply voltage of the solid state PA stage  
Air temperature of the final stage  
Air temperature of the middle stage  
Tetrode warm-up timing

**READABLE PARAMETERS ON THE EXCITER'S FRONT PANEL**

Exciter output forward power  
Exciter output reflected power  
Working frequency  
Audio deviation level for each channel  
Modulation level for SCA and RDS inputs  
Internal parameters for the various stages of the exciter



**TABLE E READABLE PARAMETERS ON THE FRONT METER PANEL**

Excessive output reflected power in antenna

Tetrode anode overcurrent

Tetrode screen grid overcurrent

Tetrode control grid overcurrent

Final stage overtemperature

Excessive reflected power against to driver

Eccessiva corrente assorbita dal driver

Driver working overtemperature

Insufficient air cooling pression

Service interruptions for not lock rack panels (personal safety)

Total power supply arrest for short circuit

Fuses on each service power supply

Fuses on tetrode filament power supplies

Protection switches for overcurrent on aircooling fans

Excessive reflected power against to exciter

Exciter working overtemperature

Exciter final stage overcurrent

Protection fuses for exciter power supply.

**TABLE F PROJECT STRUCTURE SPECIFICATIONS**

Amplifier cavity of the tetrode final stage 1/4 tuned with capacitor output coupling.

Grounded-grid configuration of the Final stage tetrode through by-pass capacitors.

Filter for output armonics attenuation the 9th order shunt type at concentraded constants installed inside of the rack.

Filter for middle stage armonics attenuation of the 9th order at concentraded constants.

Aircooling fans for each equipment.

Power supply with insertion at two steps to limite the insertion overcurrents.

Inductive-capacitor filter on the tetrode anode power supply.

Capacitors for high voltages in film in no PCB oil (no polarized).

Power resistors not connected in series to tetrode anode power supplies of the final stage to limite the energy of possible anodic discharges.

Stabilized tetrode filament power supply with electromechanical voltage stabilizer.

Single control and screen grid power supply and supplied by electromechanical voltage stabilizer.

Bleeder resistors on both grid power supplies.

Single protection circuits for each equipment.

Overvoltage soppresion circuits on data line and internal measures.

Electronic corcuits protect against discharges coming from anode power supply.

Protection circuit against electrical arcs inside the amplifier cavity.

Each device under voltage is protected by fuses.

For personal safety each circuit is interrupted from the high voltage supply.

On the fron panel the general switch interrupts only the line of low power.

## CHAPTER 2

### ELECTRICAL DESCRIPTION

#### 2.1 INTRODUCTION

This chapter describes, in detail, the operating theory of the VJ10000-TE.

To aid understanding, the unit has been subdivided into modules (fig.1A), each of which is fully described below.

#### 2.2 CONSIDERATIONS ON WORKING PARAMETERS

The tetrode transmitter is equipped with polarization circuit much versatile that allows to choose the working Class and the "circulation electrical angle".

When the transmitter is made in the firm is configured in Class B for small power input and then automatically in Class C for high input power.

This choice allows to obtain the Reflected Power values read on driver not directly connected with the absolute input reflected power on the tetrode.

The input circuit setting is optimized when the transmitter reaches the programmed output power; in fact, for lower input power is normal to read reflected power values higher than the reading on the driver meter.

The transmitter can work with different values of the maximum output power on condition that lower of 10 KW continuous.

At each power value correspond a better antenna coupling ratio for the best energy consumption efficiency of the equipment.

The best energy consumption efficiency of the transmitter is obtained when is evidence a particular effect of the IG2 current: if the input power increase on the tetrode, there is a big increasing of the IG2 current but the output power doesn't increase more.

A setting in according to the point in which you have the best energy consumption efficiency is advantageous economically, but is dangerous for the reliability.

In fact, if the mains voltage decreases lightly, the transmitter works with the tetrode saturated, with dangerous energy quantity on the harmonic components of the working frequency present in the RF cavity that can cause electrical arcs with high probability of damage on the amplifier.

Then, a value of the screen grid current near to the protection threshold could cause sometimes breakings down of the service.

If the station has a good mains voltage with variations until +/- 7%, the transmitter can be adjusted with antenna coupling to which corresponds a cavity amplifier efficiency of about 78% (Cavity Efficiency=Forward Power/VA\*IA).

When the transmitter works with an high electrical efficiency, the amplifier cavity is tuned with high Q loaded parameter value.

In This case is necessary to verify that the synchronous amplitude value doesn't increase until no admissible values.

The operator has a table of characteristics values for the tunings adjusting, but for the great importance that have some parameters against others, is correct to allow a great choice freedom and to left to the operator competence the decision about the values to set the transmitter.

The limits that mustn't reach are:

- Anode current = 3,6A
- Control grid current G1 = 300mA
- Screen grid current G2 = 300mA
- Output reflected power = 750V with a continuous working of 10KW in antenna
- Anode dissipated thermal power of tetrode > 10KW
- Electrical power consumption efficiency of the amplifier cavity > 80%

The typical working tetrode values for 10KW output power in antenna are:

- Anode voltage = 10700V
- Anode current = 3.10A
- Control grid current G1 = 50-150mA
- Screen grid current G2 = 150-200mA
- Driver power = 900W

When the transmitter is tuned to work correctly at 10KW of output power in antenna, the final amplifier doesn't present good working parameters if it works at low power.

Note that in this configuration the transmitter cannot work absolutely for long periods with output power in antenna less than 7KW because the value of thermal power dissipation will be greater than maximum value admissible for tetrode anode.

The reflected power value too read on the driver meter is never minimum when the transmitter doesn't work at maximum output power for which is been setted.

## 2.3 TUBE

This power amplifier uses mainly the 4CX12000A tube.

The 4CX12000A is a ceramic/metal power tetrode intended for use as a VHF power amplifier. It features a type of internal mechanical structure which results in high RF operating efficiency. Low RF losses in this structure permit operation at full ratings to 110MHz.

The 4CX12000A provides high gain in FM broadcast service, and is also recommended for RF linear power amplifier service. The anode is rated for 20Kw of dissipation with forced-air cooling and incorporates a highly efficient cooler of new design.

It is also recommended for use as a grounded grid FM amplifier. In addition, grounded-grid operation is attractive since a power gain as high as twenty times can be obtained.

## 2.4 R.F. CAVITY

The R.F. Cavity is accessible when are been removed the fixed screws of the front panel.

It's divide in three sections: the top section in which is placed the motorizations of the tunings; the central section in which is fixed the tube and the bottom section in which is placed the tube socket.

A temperature probe is placed externaly on the air chimney that is placed on the top of the R.F. cavity. The protection circuit that continuously monitors this probe, switch of the amplifier in case of overtemperature.

This section of the chamber is mounted on four motorized bars and can go up and down in according to desired transmission frequency.

In the central section of the chamber, around the tube's socket, is situated a collar with fingers to ground the control grid.

The socket is situated in the bottom section, into which the tube is inserted.

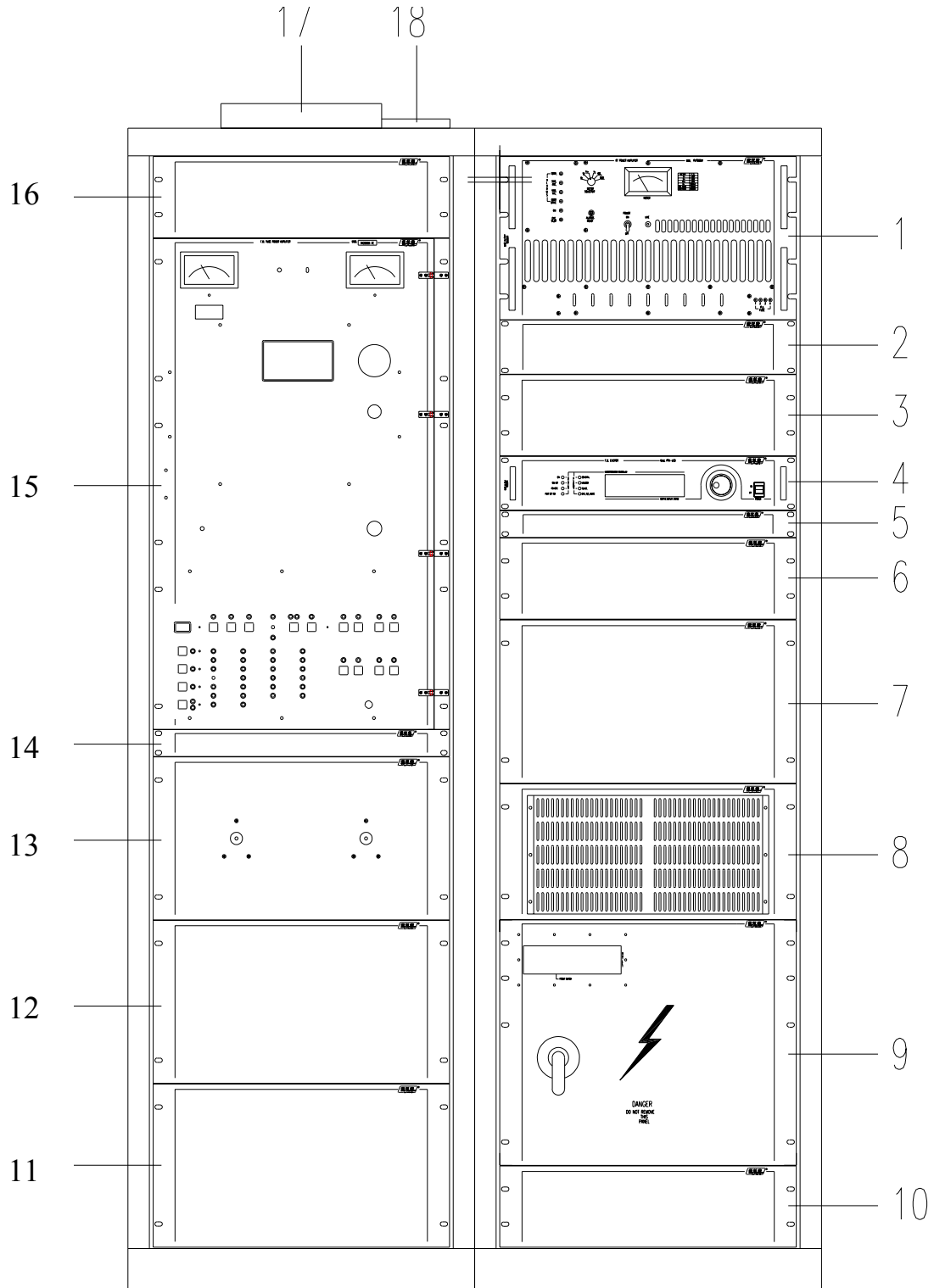
**TABLE G SPECIFICATION OF THE 4CX20000C TUBE**

Model	4CX12000A
Anode dissipation	12000 W
Grid dissipation	150 W
Frequency for max. ratings (CW)	110 MHz
Cooling	Forced ventilation
Filament voltage	6.50 V
Filament current	110.0 A
Input/Output Capacity	0.08 Pf
Amplification factor	16 dB
Base	Special coaxial
Recommended air system socket	SK-300
Recommended air chimney	SK-336
Maximum seal & Anode core Temperature	250°C
Maximum length	24.99 mm (9.84")
Maximum diameter	22.50 mm (8.86")
Weight	9.06 Kg (20.0 Lbs)
Operating position	Vertical

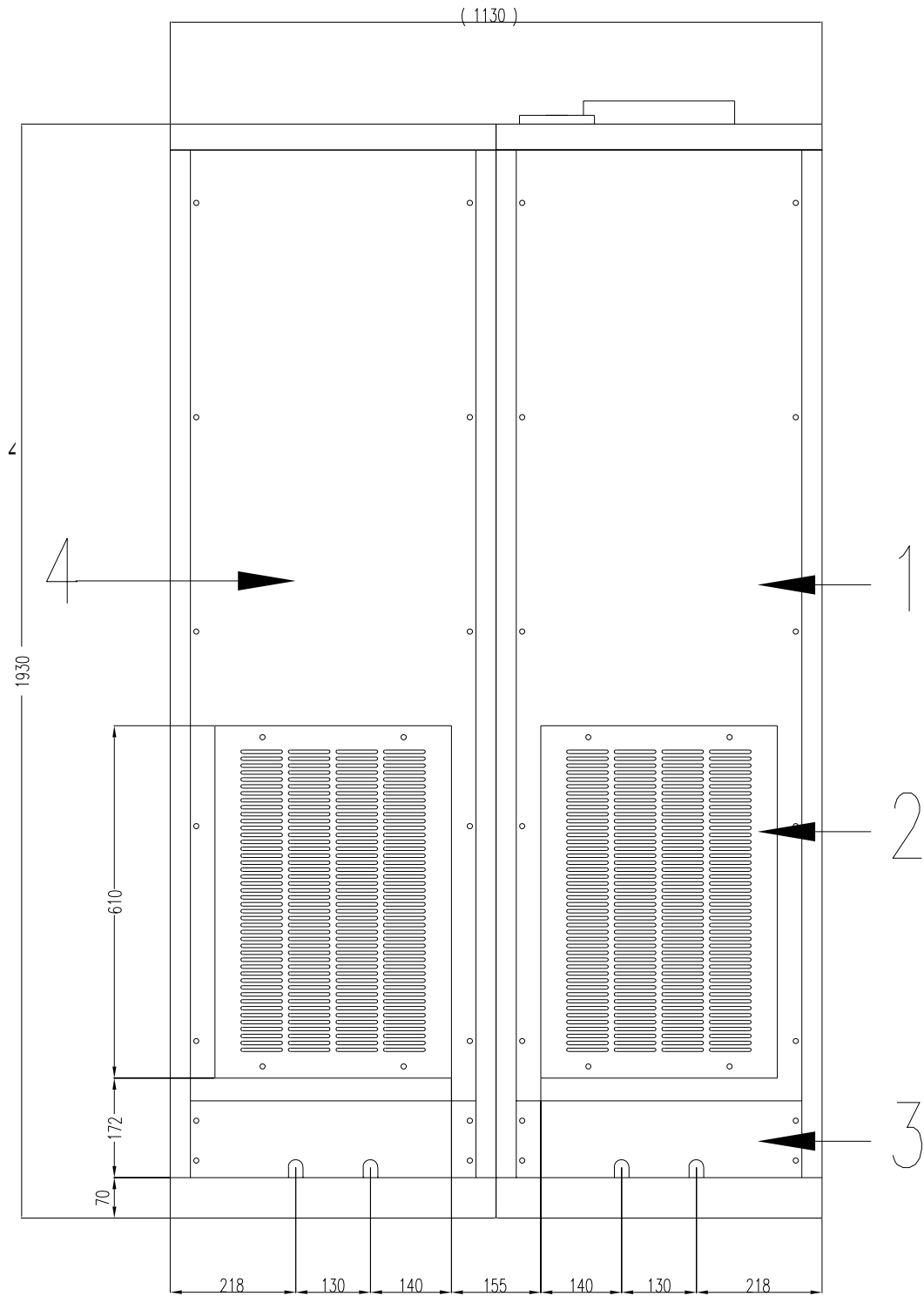
**FIG. 1 FRONT VIEW DESCRIPTION**

- 1) Mos-Fet Wideband amplifier, strip line technology, output power 1000W.
- 2) Free Panel.
- 3) Free Panel.
- 4) F.M. exciter controlled by microprocessor, stability 2.5 ppm, 10khz steps, output power from 0 to 30W adjustable, with LCD graphic display.
- 5) Free Panel.
- 6) Free Panel.
- 7) Free Panel.
- 8) 10 Kw amplifier cooling air input filters.
- 9) Hight tension panel.
- 10) Free Panel.
- 11) Free Panel.
- 12) Free Panel.
- 13) 10 Kw amplifier num null adjustment.  
10 Kw amplifier filament voltage adjustment.
- 14) Free Panel.
- 15) Protection Panel.
- 16) Free Panel.
- 17) 10 Kw amplifier hot air outlet.
- 18) 10 Kw amplifier 3"+1/8 R.F. output connector

### FRONT VIEW





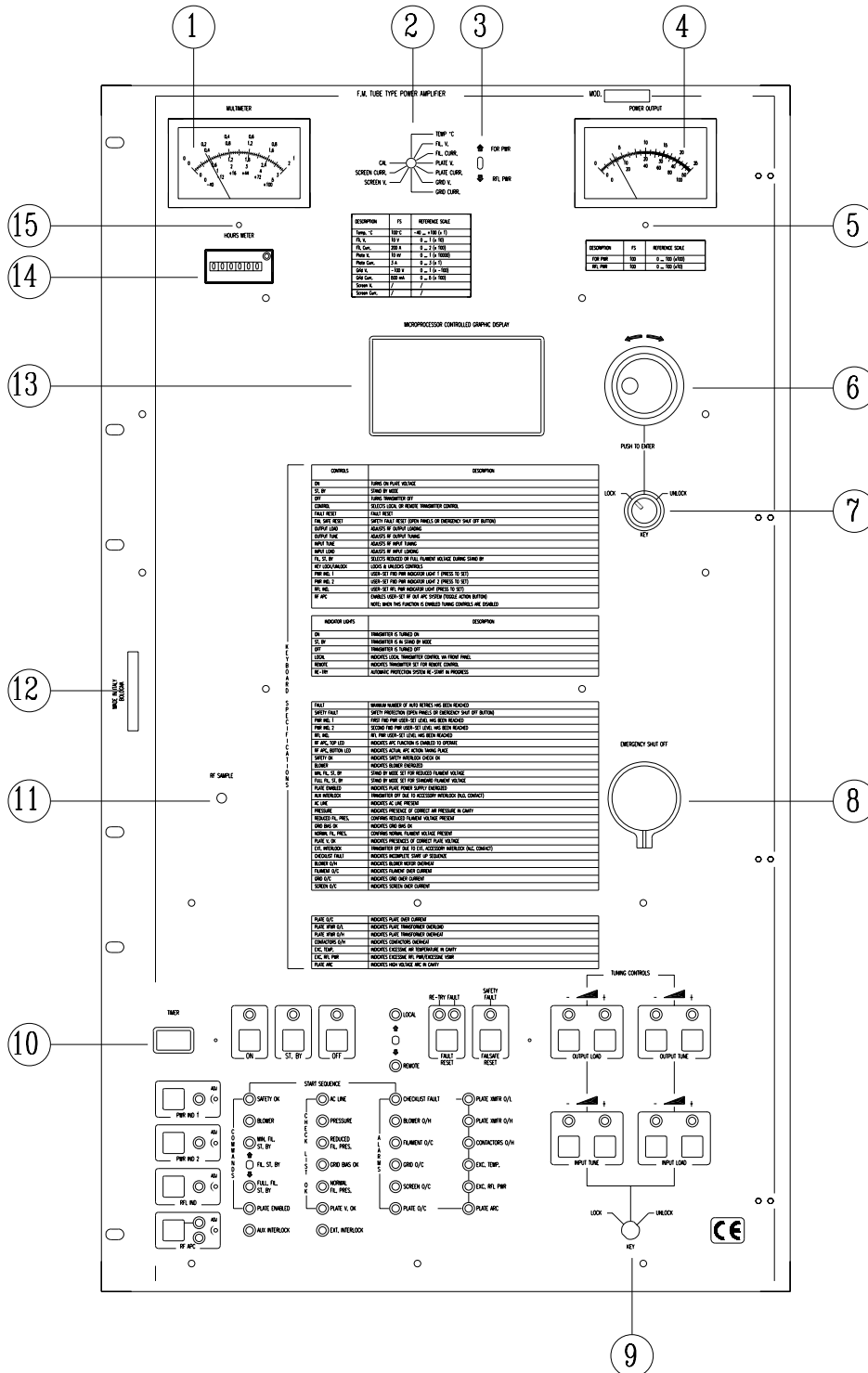


**FIG. 2 REAR VIEW**

- 1) Rear cavity panel.
- 2) Air filter panel.
- 3) Pass-through power supply cables panel.

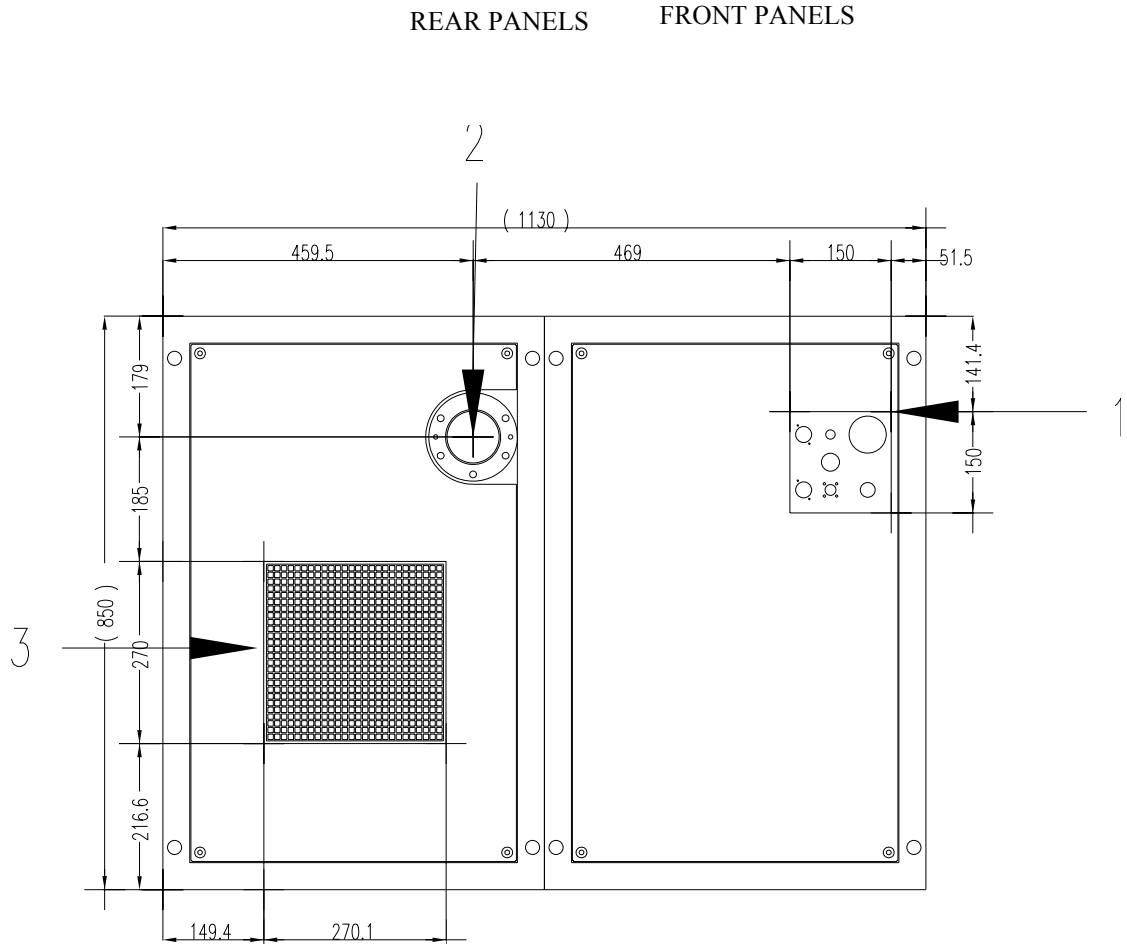
### 4) Instruments rear Panel.

**FIG. 3 HINGED FRONTAL PANEL WITH TELEMETRY**

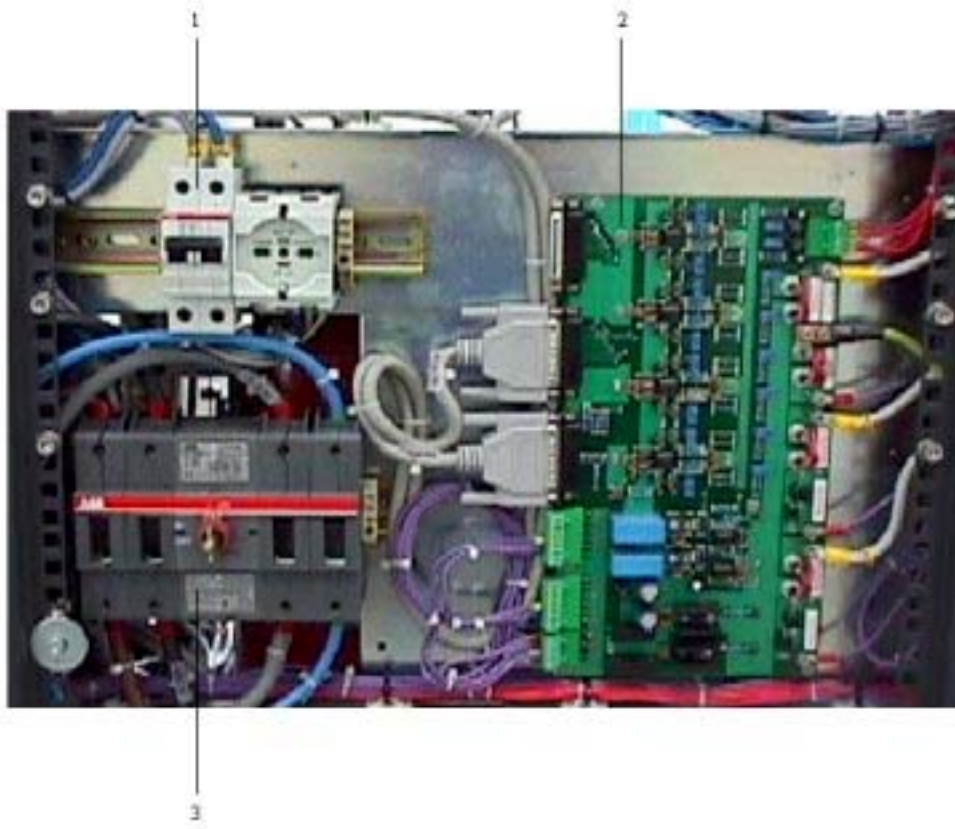


<b><i>REF.</i></b>	<b><i>DESCRIPTION</i></b>
1) <b>MULTIMETER:</b>	Analog instrument for the measures of temperature, filament voltage and current, anode voltage and current and grid voltage.
2) <b>VOLTAGES SELECTOR:</b>	Voltages selector for the measures of the following.
3) <b>FWD/REF SELECTOR:</b>	Selector for forward / reflected power measure.
4) <b>POWER INSTRUMENT:</b>	Analog instrument for the measure of the forward and reflected power
5) <b>INSTRUMENT RESET:</b>	Mechanical reset of analog instrument for the measure of the forward and reflected power.
6) <b>ENCODER:</b>	Encoder for telemetry connection (optional).
7) <b>ENCODER SWITCH:</b>	Key switch to enable the telemetry (optional).
8) <b>EMERGENCY PUSH SWITCH:</b>	Emergency push switch to stop the equipment.
9) <b>TUNING KEY SWITCH:</b>	Key switch to enable the motorized tuning.
10) <b>TIME FILAMENT DISPLAY:</b>	Display for the screening of the pre-heating filament time.
11) <b>R.F. SAMPLE:</b>	Connector for R.F. signal test.
12) <b>HANDLE:</b>	Handle to open the hinged panel
13) <b>DISPLAY:</b>	Display for the screening of the equipment and telemetry parameters (optional).
14) <b>HOURS COUNTER:</b>	Equipment working hours counter
15) <b>VOLTAGES RESET:</b>	Mechanical reset of analog instrument.

**FIG. 4 TOP VIEW DESCRIPTION**



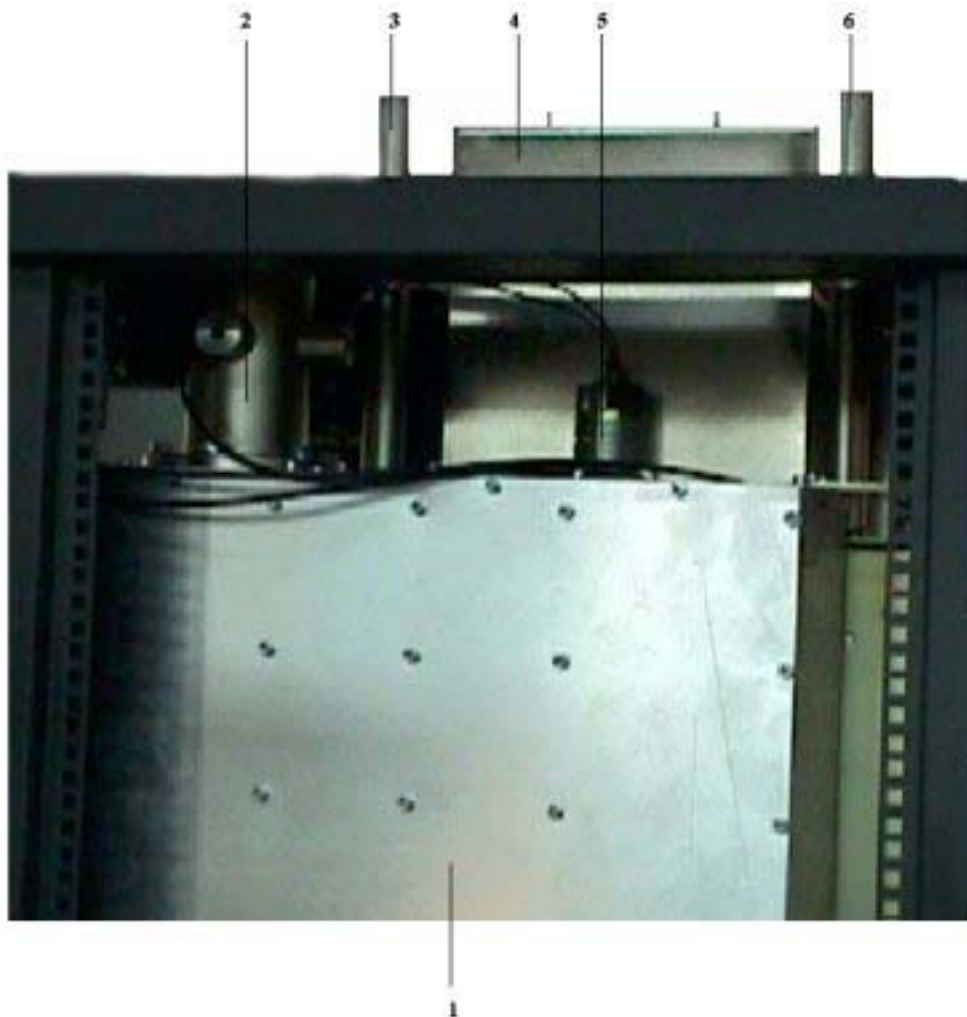
- 1) Out connectors.
- 2) hot air outlet.
- 3) 3"+1/8 R.F. output.

**FIG. 5 PROTECTIONS CARD DESCRIPTION**

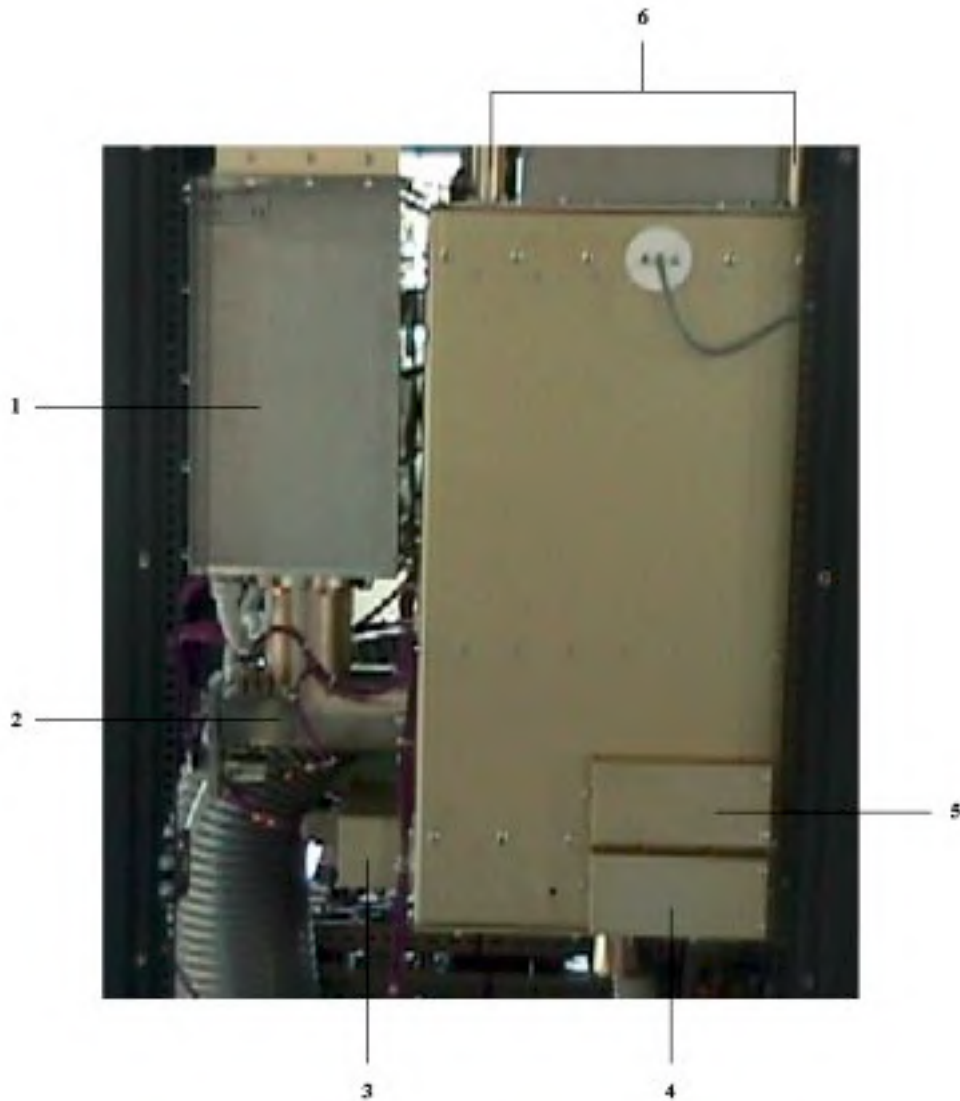
- 1) Utilities protection switch.
- 2) Working parameters measurement card. This card picks up all electrical measures of the power grid tube in order to send the requested signals toward the multimeter card, allarms box and remote control/telemetry.
- 3) General disconnecting switch.

**FIG. 6 R.F. CAVITY'S FRONT VIEW DESCRIPTION**

- 1) HIGT VOLTAGE SHORT CIRCUIT.
- 2) VARIABLE CAPACITOR (MOVING SURFACE WITH FINGERS)
- 3) KAPTON
- 4) TEFLON RING TO PROTECT ELECTRIC ARC
- 5) COLLAR FOR 4CX20000C TUBE
- 6) TEFLON CAP WASHER(LOAD)
- 7) TUNE LIMIT-STOP
- 8) CAVITY INTERLOK

**FIG. 7 WATTMETER VIEW DESCRIPTION**

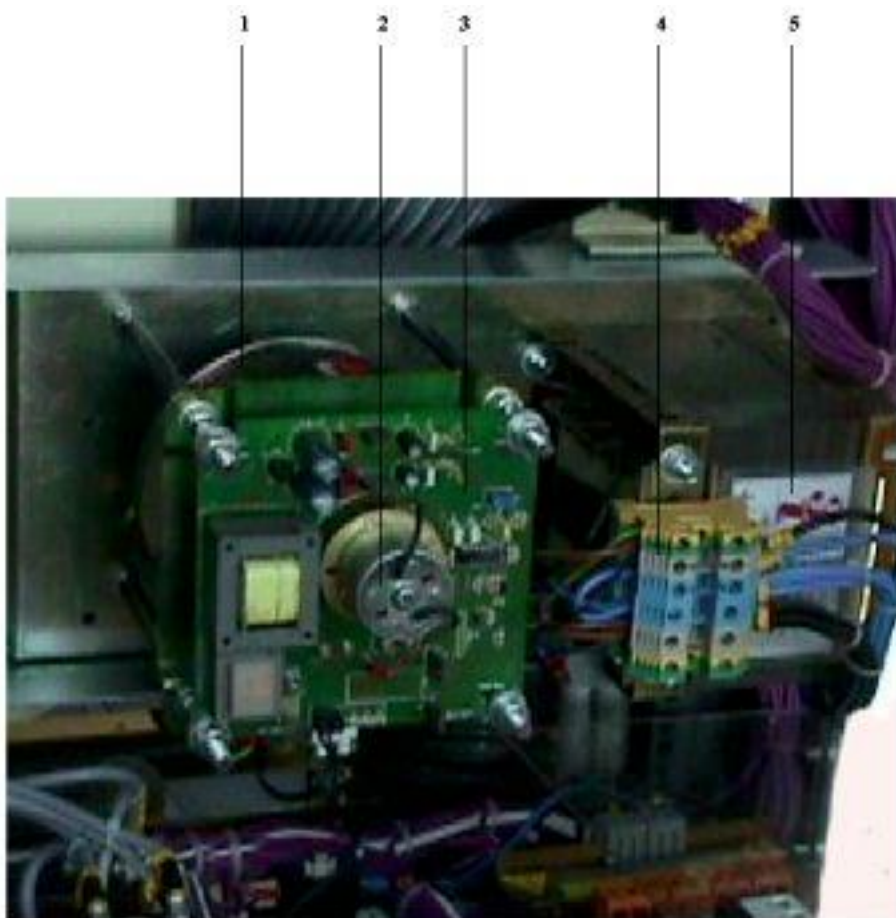
- 1) LOW PASS FILTER.
- 2) WATTMETER.
- 3-6) COVER THREAD BARS.
- 4) AIR -FLOW CHIMNEY.
- 5) TUNING MOTOR.

**FIG. 8 R.F. CAVITY LEFT SIDE VIEW DESCRIPTION**

- 1) LOW PASS FILTER.
- 2) 3"+1/8 R.F. OUTPUT WITCH MOTOR LOAD.
- 3) INPUT TUNING ADJUST -INPUT GRID ADJUST.
- 4) VG1 INPUT VOLTAGE.
- 5) VG2 INPUT VOLTAGE.
- 6) THREAD BAR COVER

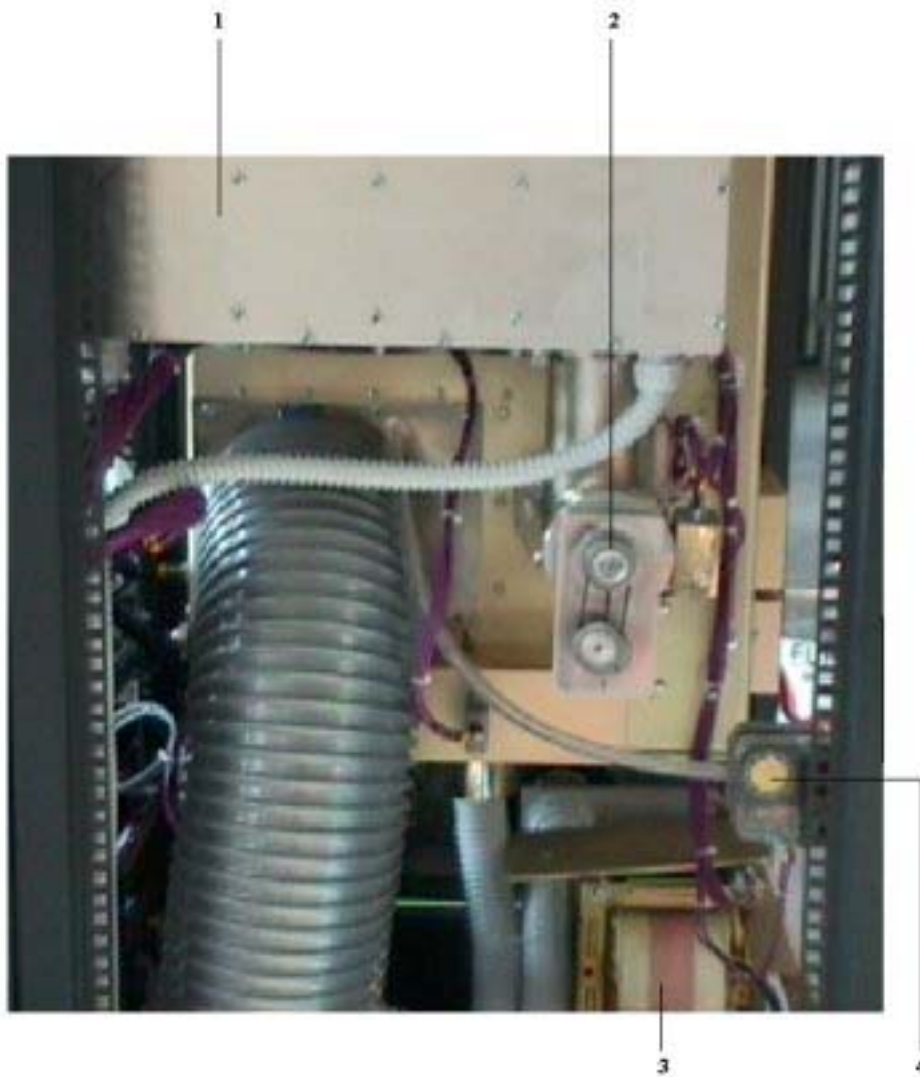


**FIG. 9 VOLTAGE STABILIZER DESCRIPTION**



- 1) ADJUSTABLE AUTOTRANSFORMER.
- 2) SERVOMOTOR.
- 3) CONTROL CIRCUIT.
- 4) SOCKET.
- 5) SERIES TRANSFORMER.

**FIG. 10 R.F. CAVITY'S REAR VIEW DESCRIPTION**



- 1) LOW PASS FILTER.
- 2) 3"+1/8 OUTPUT.
- 3) FILAMENT TRANSFORMER.
- 4) PRESSURE SENSOR

**FIG. 11 DETAIL REFERENCE**



CAPSCREW

## CHAPTER 3

### INSTALLATION

#### 3.1 INTRODUCTION

This chapter contains the information necessary for the installation and preliminary checks of the VJ10000-TE Triode amplifier.

#### 3.2 UNPACKING

Remove the unit from its packing and, before anything else, ensure that the unit has not suffered any damage during transit and that all front panel controls are operational.

#### 3.3 ASSEMBLY DESCRIPTION

##### RECOMMENDED TOOLS FOR THE INSTALLATION OF VJ10000-TE

N_1	Middle star screwdriver
N_1	Small star screwdriver
N_1	Middle slot screwdriver
N_1	Big slot screwdriver
N_2	Double head wrench N_10
N_2	Double head wrench N_13
N_1	Socket wrench N_7 about L= 30 cm
N_1	Socket wrench N_8
N_1	Socket wrench N_13
N_1	Setscrew wrench for screws M6 (ALLEN)
N_2	Setscrew wrench for screws M8 (ALLEN)

#### 3.4 ASSEMBLY PROCEDURES FOR THE INSTALLATION OF VJ1000-TE

After you have removed two racks from the wooden packing, is advisable to remove all covers and to place one rack near to the other in vertical position. Then, you must connect the two racks by the apposite cap screws that are fixed on the rear part of the rack with n°4 Allen scrwes M8.(fig.8)

These cap screws must be placed on the uprights of the racks, two of them on the top position and two on the down position.

To execute this operation it's necessary to check that two racks are on the same plane to avoid problems in their alignment.

Then, it's necessary to connect the wires, between the two racks, on the socket placed on the bottom part of the rack being carefully to respect the position of wires.

Now, you must connect the wires that supply the multimeter with the DB25 connector of the card placed on the left side of the multimeter on the R.F. cavity Before to work on this card it's advisable to remove the left cover of the Radio frequency group rack.

Inside of one of other packing they are three pipes with graduate flange, that must be placed on the upper part of the cavity as protection of the bar that are used for the tuning.

There are three pipes (used to cover the bars) with the same lenght and one with a hole d= 12mm that must be used to cover the bar over end tuning micro switches.

To mount this pipe is advisable to remove the micro switches before by the relative screws.

The screws that must be used to fix this pipe are just mounted in the relative holes placed on the top of the cavity.

Now, you can connect the wires relative to the power supply of the blower's motor, with the same sequence marked both on the wires and on the motor's poles (ABB).

In this moment you are ready to connect the mains voltage wires to the equipment.

To realize this operation you must connect the three phases to the fuses opening the relative fuses socket placed on the rear part of power supply rack and by a slot screwdriver you must turn the screw placed on his bottom part.

Now, you can remove the poles protection discovering the screws and by a socket wrench N°13 you can connect the mains voltage wires by the apposite wire terminals that is supplied to you inside of the spares box, while the neutral and ground wire must be connected to the poles placed near to fuses box marked respectively with blu and yellow-green colors.

It's very important to check that when you switch on the equipment the blower motor is on, otherwise you must check the exact positions of the phases wires so that the overload cutout can allow to start the equipment.

Another confirmation of this you can have from the led of the three-phases controller that normally is of green color, naturally with the automatic switch placed in the front panel in the position ON.

Remember to connect the RF connector on the 1/2" Celflex cable to the 7/16" connector placed on the input cavity under the input air cavity pipe.

To complete the assembling of the equipment it's necessary to mount output air chimney with the BNC connector forward the rear part because to this connector must be connected the BNC mounted on the RG58 cable of the output air temperature probe.

Then, to complete the mounting of the chimney fix the screws on his top part.

When you complete this operation and re-check all wires and cables, you can continue with the other operations.

### **3.5 TRANSMITTER CONNECTION TO MAINS VOLTAGE**

The transmitter connection to the mains voltage is placed in the rear part of the rack (fig.1B).

The wires of mains voltage must be connected in this way: the three phases must be fixed to three anchorages present on the high power fuses socket.

When is connected to electric line is necessary do attention. The amplifier can expose the operator to current and voltage dangerous.

After the connection to the electric line it is necessary make a control.

After the connection to the electric line is necessary make a control. Looking the apparatus in the rear of the power rack ( 50cm height ), is possible to see leds power revealing the correct operation. If led's is not turned on is present possibles anomalies

Wrong position of phases or absence current. Then immediately lift for some instants the general interrupter on the frontal panel. If the overload cutout doesn't remain active, to be sure that the mains voltage is correct or that the blower isn't blocked.

When finish these operations the connection to the electric line is completed.

The neutral and the ground must be connected to the wires connections placed near to fuses socket. Connect the mains voltage cables in according to DELTA or STAR installation.

In case of DELTA configuration isn't necessary the neutral connection while for STAR configuration the neutral connection is necessary too.

The three phases connection cables must have minimum section of 25 mm<sup>2</sup> for a voltage of 380/415 V and must have minimum section of 35 mm<sup>2</sup> for a voltage of 208/240 V.

The ground connection must be executed by a cable with a section of 35mm<sup>2</sup>.

The main switch (monophase) present on the front panel switch off only the power supply of the services with small energy absorption but not the completely high power line.

WHEN THE EQUIPMENT IS CONNECTED TO THE MAINS VOLTAGE IT'S NECESSARY TO BE VERY CAREFULLY BECAUSE THE INTERNAL PARTS OF EQUIPMENT CAN CAUSE THE DEATH OF THE OPERATOR FOR FULGURATION.

After the connections to the mains voltage it's necessary to realize a small checking.

Looking at the equipment in the rear part of the power supply rack (at the height of the knee) it's possible to see a three phases controller with led indicator ON.

If this led is OFF there is the possibility to have one of the following two anomalies: the first is that is absence the mains voltage, the second is that one phase version isn't correct.

For this last case is sufficient to change the position of two phases wires.

With the mains voltage present, you must switch on the main switch on the front panel for few seconds and then switch off again the main; during these few seconds check the rotation verse of the blower.

If the rotation isn't correct, it's necessary to invert the position of two of the power supply wires placed on the main metre of the blower.

When you have ended these operations, the connection to the mains voltage is completed.

### 3.5 TUBE INSTALLATION

Only when the equipment is correctly connected to mains voltage it's possible to install the tube inside of the RF cavity of the amplifier.

The power supply is necessary to allow to the tuning meter to move some mechanical parts, but it's necessary to switch off the main blower before to start the operation on the RF cavity.

On the front panel of the right rack, open the panel that allows the inspection of the electronic cards, the fuses and the protection switch of the blower.

Place on OFF position the protection switch of the main blower (on the top position in the right side). Open the cover panel of the R.F. cavity placed on the top of the left rack (fig.9A). It isn't necessary to open other panels of the cavity. Switch on the power supply by the main switch placed on the front panel of the right rack. Move one of the four tuning commands (on the top in the right side) so that the grounded bridge (plate tuning) inside of the RF cavity reaches the highest position possible.

Realise the plate tuning pipe clamp placed on the top of the RF cavity. With hands push up the plate tuning pipe until it's inserted in the grounded bridge. The pipe must be pushed up until remains free a sufficient space to insert the tetrode inside the socket (fig.9B).

When the pipe is on the top position, clamp the clip of the pipe so that is fixed in this position. Take the tube from one of the other packing paying more attention to: don't touch with free hands the ceramic parts of the tube, and don't cause damages with big crashes.

Now, insert the tube inside the relative socket, and check if the position is correct inside the fingers of the socket. When the position is correct, realise the clip of the pipe until the position of the antenna coupling capacitors are parallel both in vertical and radial position.

Make sure that the contacts between pipe and tube, clamping verywell the clip placed on the bottom part of the tuning pipe (fig.9C). Then, clamp the other clip placed on the top of the tuning pipe. Check inside the R.F. cavity so that there aren't anything and then close the

cover. Switch off the equipment and then place on the ON position the protection switch of the blower.

Now, after these operations is possible to close all covers and panels.

### 3.7 TUNING AND SWITCH ON PROCEDURES

The high power switching on operations must be executed only when you have ended all other operations, placing mains voltage and antenna connections.

**PAY PARTICULAR ATTENTION TO THE ANTENNA CONNECTION**, because it isn't admitted, when you work with radio frequency systems, to use a connection to a non adequate antenna or to not sure connections.

For the frequency tuning operations on the equipment is useful to have a spectrum analyzer, but it's possible to operate in any case with the help of the measures available on the front panel, but the time necessary is longer.

Before to switch on the equipment verify that the modulator is setted for the minimum output power, then it's necessary to set the indicator meters of the variuos equipment for the reading of the following parameters: Reflected power for the driver and VG1, VG2, IA and Forward power for the final amplifier.

At the moment of the switching on, the transmitter executes a sequence of programmed operations. If all prestart parametrs are correct, a warm-up timer ends its counting after 90 seconds. Then, the equipment is ready to start the working at high power.

Set the service switch on the stand-by position; with this operation the anode and grid 2 power supply are inserted in two different steps at 2 seconds one from the other, at last, is enabled the modulator working.

In this transmitter configuration, the tube is supplied on the anode; for this reason it's impossible to detect a small anode current of 100/200 mA.

Increase slowly the output power of the modulator by its control power.

Check that the modulator reflected power remains under 40/60 W.

Then, increase again the driver output power until the anode current is 350/450 mA.

If the reflected power is greater than 40/60 W, make various attempts alternatively on the two regulations of the input tuning of tetrode (on the bottom position) until this value is correct. When on the tetrode is possible to detect an anode current of 350/450 mA, adjust the tetrode output tuning (on the top in the right side) moving the push forward to (+) position until compares a reflected power indication in antenna.

Adjust this push button forward to (+) or (-) for the indication of the maximum relative power in antenna. Increase lightly the modulator power checking and correcting always the input tunings of the tetrode until to obtain the minimum value of the driver reflected power.

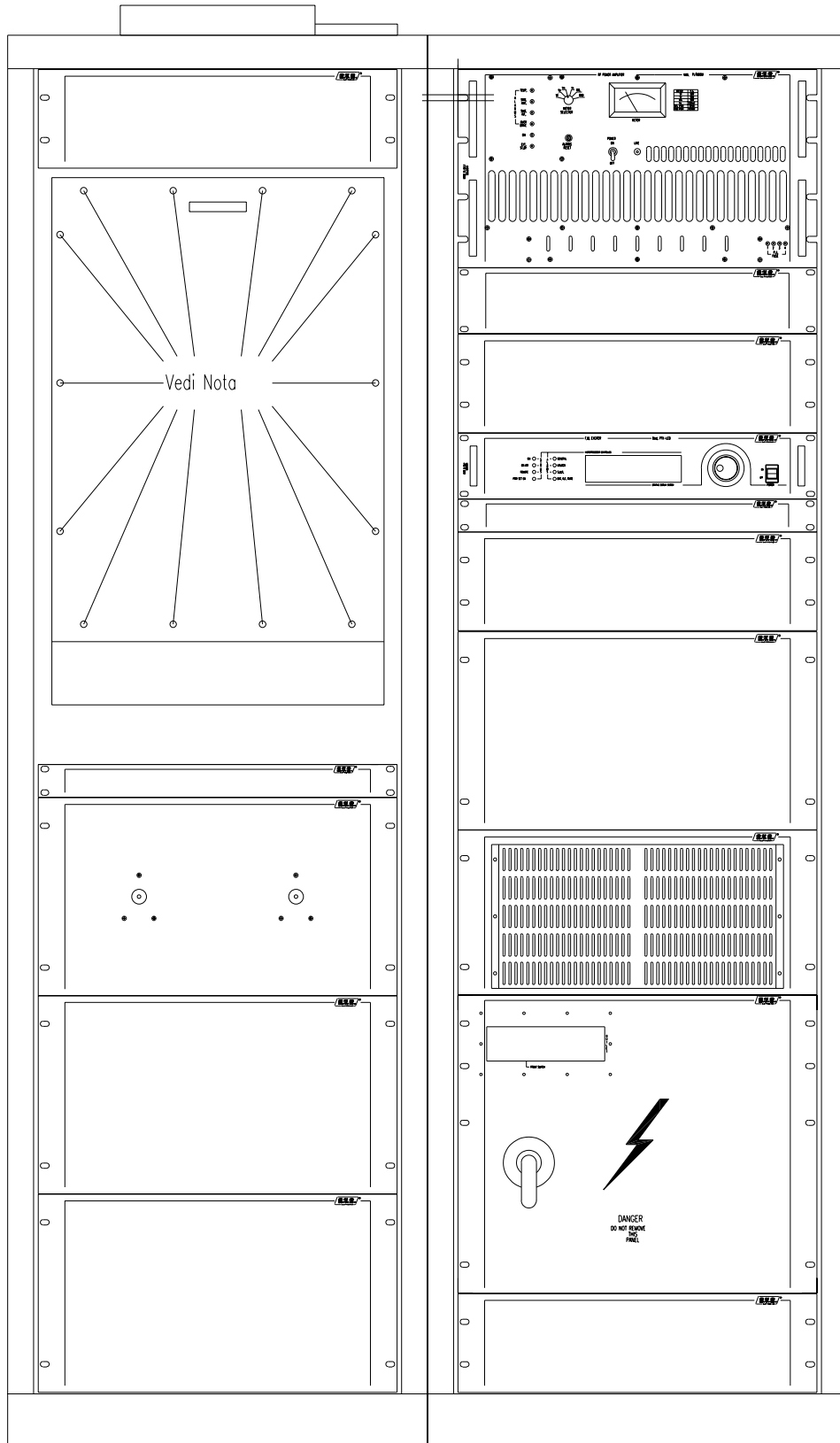
After the frequency tuning operation of tetrode, is necessary to execute the according antenna operations. This last operation is advisable when the output power has exceed the value of 8-10 KW. If tetrode isn't correctly according to antenna, the values of the anode current and the two grids currents aren't correct, and in this case the amplifier doesn't increase the output power with a relative increase of the input power.

The push button of antenna tuning (on the top in the left side) allows to correct the IA, IG1, and IG2 currents values in according to output power. Each once it's been necessary to adjust the antenna coupling (push button on the top in the left side) **IT'S ABSOLUTELY NECESSARY TO ADJUST THE OUTPUT TUNING** (push button on the top in the right side) to obtain the maximum value of the forward power in antenna.

Repeat this sequence of operations (increasing of the input power, correction of the input tuning for the minimum value of the reflected power on the driver, adjusting of the antenna coupling and final fine adjust of the tuning) until you have obtained the maximum programmed output power.

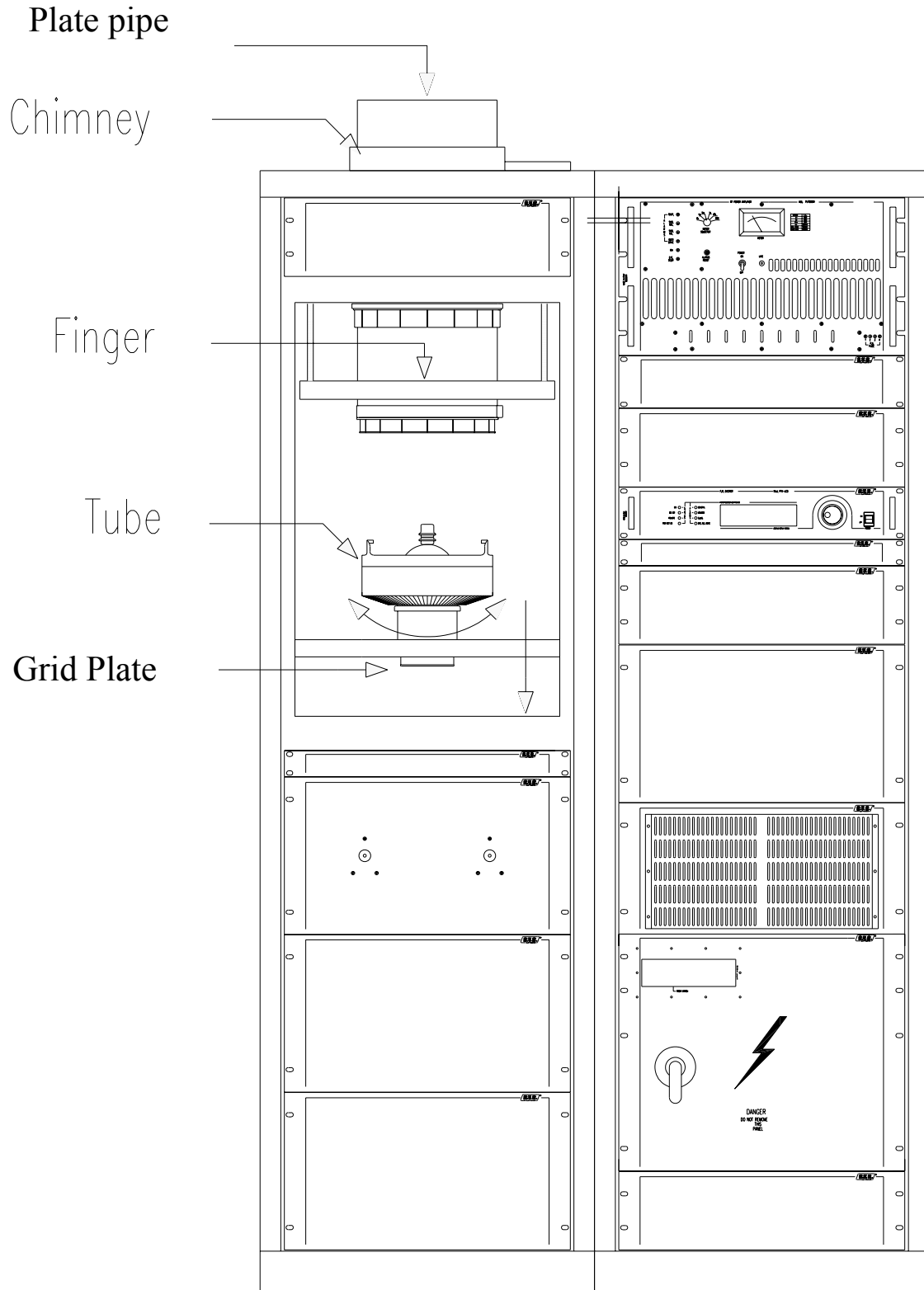


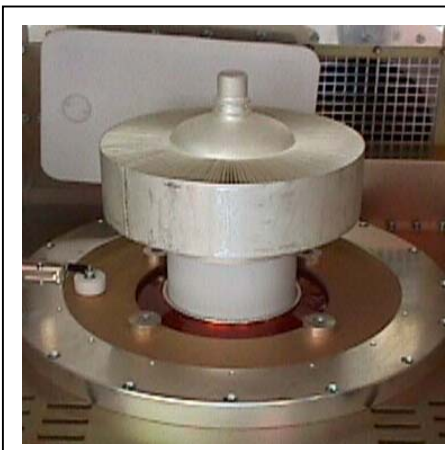
**FIG. 12 TUBE INSTALLATION DIAGRAM N°1**



NOTE: SCREWS FOR REMOTION FRONT PANEL

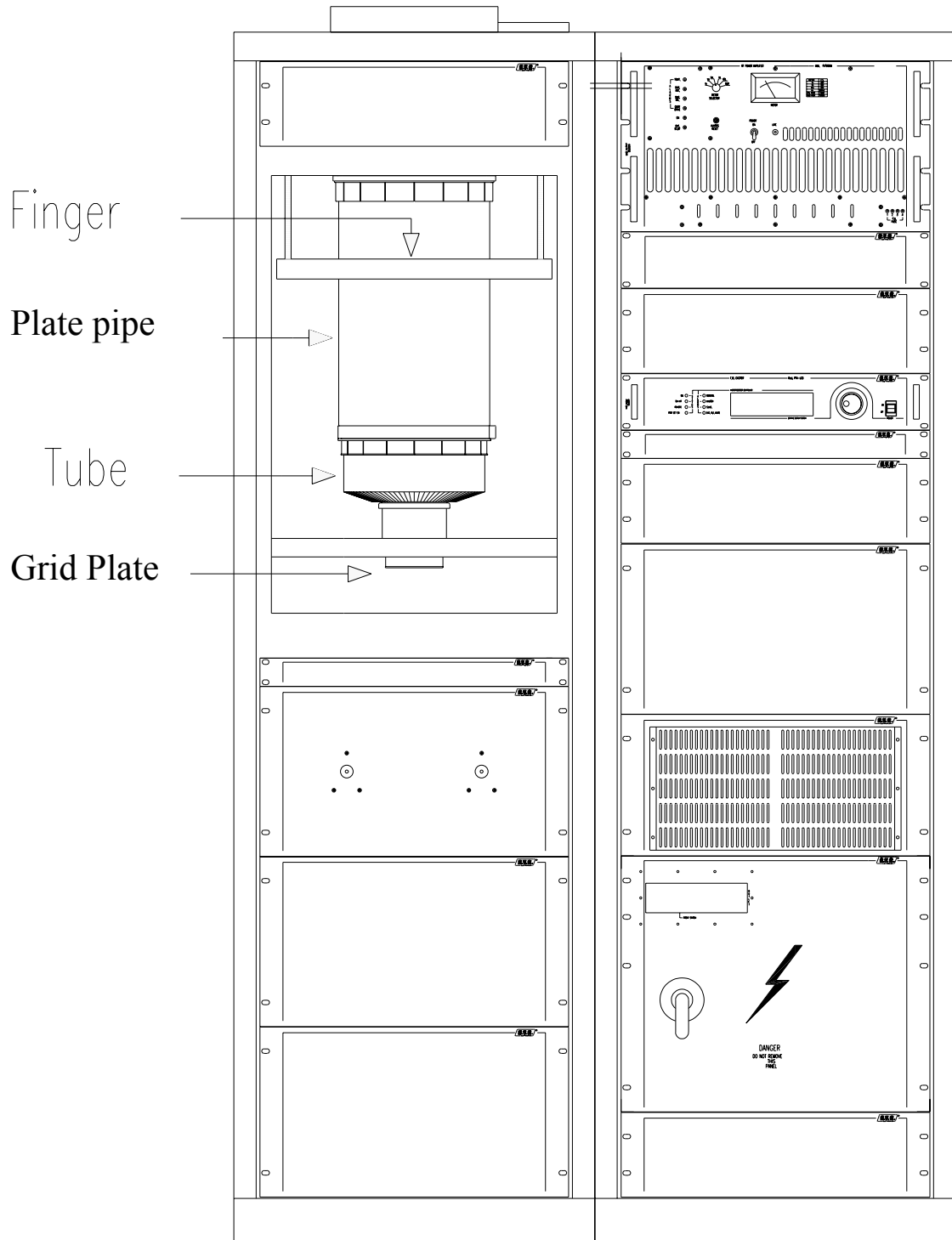
FIG. 13 TUBE INSTALLATION DIAGRAM N°2

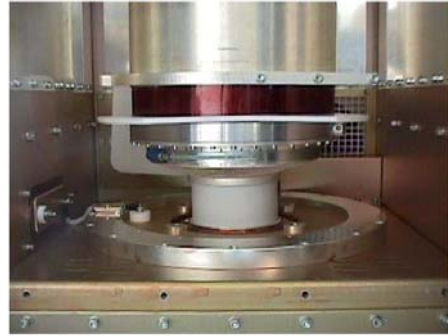




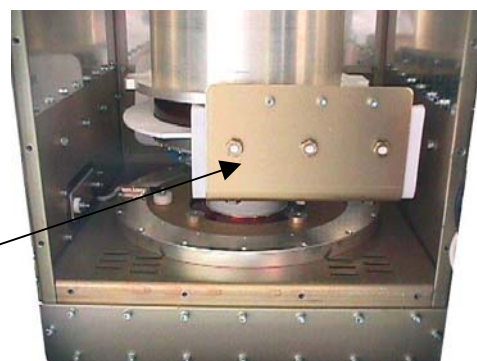
REFERENCE WIEV FOR VALVE  
INSTALLATION INTO CAVITY  
CHAMBER.

FIG. 14 TUBE INSTALLATION DIAGRAM N°3





CLOSE THE SCREWS ON  
PLATE VOLTAGE. BE SHURE  
TO INSERT CORRECTLY THE  
VALVE INTO CAVITY .



REFERENCE WIEV OF CAPACITY  
LOAD

## CHAPTER 4

### MAINTENANCE

#### 4.1 SAFETY REQUIREMENTS

##### WARNING WARNING WARNING WARNING WARNING WARNING WARNING

When the transmitter is operational, removing the rear panel will expose lethal voltages. Use insulated tools for all types of adjustment and do not touch any internal components when the unit is switched on.

Ensure that the unit is disconnected from all sources of power before carrying out any inspection or maintenance work.

#### MAINTENANCE LEVEL 1

#### 4.2 ROUTINE MAINTENANCE

The only routine maintenance required by the amplifier is the periodic inspection of the cooling fans, the replacement of the air filter and the removal of dust from the tube cavity.

The period between such action will depend on ambient operating conditions such as temperature, air-borne dust levels and humidity. It is advisable to check the unit every 3 months, replacing worn or noisy fans.

Eventual replacement of the tube will also be necessary.

The life of the tube will depend strongly upon operating conditions: eg. line voltage fluctuations greater than  $\pm 5\%$ , ambient temperature greater than 30 °C, high humidity, presence of dust and misalignment of the amplifier will all lead to a greatly reduced tube life.

#### MAINTENANCE LEVEL 2

#### 4.3 MODULE REPLACEMENT

N.B. TO FIT A MODULE, FOLLOW THE REMOVAL PROCEDURE IN REVERSE.

N.B. THESE PROCEDURES SHOULD ONLY BE CARRIED OUT BY HIGHLY SPECIALIZED TECHNICIANS USING THE CORRECT EQUIPMENT.

MAINTENANCE ERRORS CAN CAUSE SERIOUS DAMAGE TO THE UNIT AND WILL AUTOMATICALLY MAKE THE WARRANTY VOID.

#### **4.4 TUBE REPLACEMENT**

- 1) Move the sliding panel to its upper limit (rods fully exposed), using the PLATE control.
- 2) Disconnect the line supply from the unit.
- 3) Ensure that the tube has cooled sufficiently to avoid severe burning.
- 4) Ensure that all internal voltages are at 0V; use a shorting-stick, if necessary.
- 5) Unscrew the fixing screws of the front, hinged access panel of the chamber (fig.9A).
- 6) Unscrew the fixing screws of the chamber panel (fig.9A).
- 7) Remove the air outlet flue with the protective net (fig.9B).
- 8) Loosen the anode tube fixing collar (fig.9B).
- 9) Raise the anode tube as far as possible and keep it in that position.
- 10) To re-fit the tube, follow the procedure described in paragraph 3.6, Tube Installation.

#### **4.5 AIR FILTER REPLACEMENT**

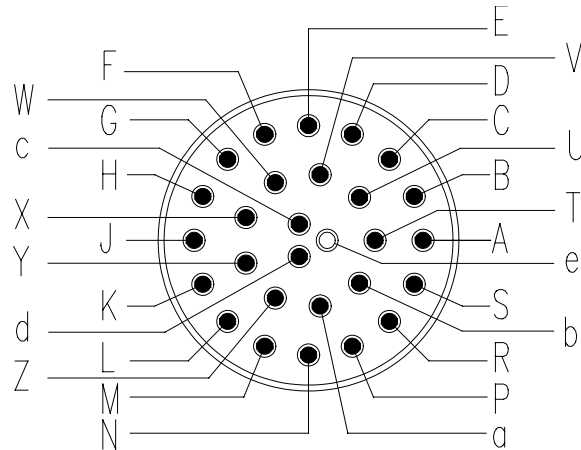
- 1) Disconnect the line supply from the unit.
- 2) Open the rear grill (1 fig.1B) of the air filter, undoing the fixing screws.
- 3) Change the felt air filter, carefully cleaning inside.
- 4) Close the rear grill and tighten the fixing screws.
- 5) Reconnect the line supply.

### **APPENDIX A**

#### **CIRCUIT DIAGRAMS, LAYOUTS AND BILLS OF MATERIAL**

This section contains circuit diagrams, layouts and bills of material of the modules which composing the equipment.

For more information about each module see as reference Section 2.

**FIG. 15 I/O RACK CONNECTORS**

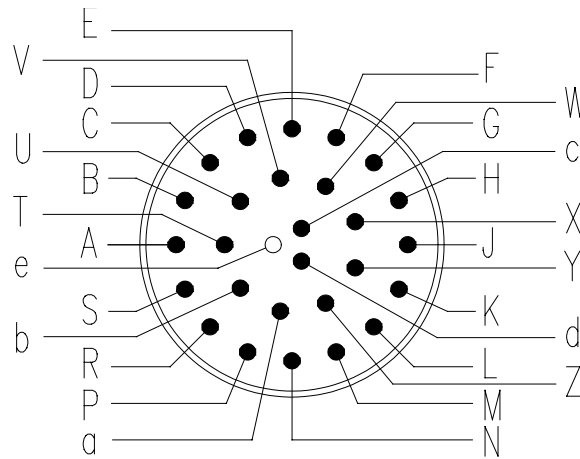
28 Pin Female Connector

Rack connections		
Pin Letter	Description	Numeration cable
A	Clamps Overheat	2
B	Anode Trasformer Overheat	3
C	Anode Trasformer Overheat	4
D	Blower Overload	5
E	Anode Supply	8
F	Grid Bias	9
G	Mains	10
H	+Vcc for Input Aux-Ext	15
J	Safety	12
K	+Vcc for All Sensor	13
L	From Interlock n°13 to Interlock n°14	48
M	From Interlock n°21 to Remote Control Switch Card	58
N	16V	26
P	0V	27
R	16V	28
S	Filament Voltage measure	30
T	Filament Voltage measure	31
U	Filament Current measure	32
V	Filament Current measure	33
W	Digital Input Aux Interlock	6
X	Digital Input Ext Interlock	7
Y	Hours Meter	63
Z	Hours Meter	65
a	A.C. Input 12V for Motors Card	71
b	A.C. Input 12V for Motors Card	72
c	A.C. Input 21V for Microprocessor Card	69
d	A.C. Input 21V for Microprocessor Card	70
e	Not Connected	

- A) I/O Rack Connectors.  
 B) Reference View.



**FIG. 16 I/O RACK CONNECTORS**



28 Pin Male Connector

Rack connections		
Pin Letter	Description	Numeration cable
A	Clamps Overheat	2
B	Anode Trasformer Overheat	3
C	Anode Trasformer Overheat	4
D	Blower Overload	5
E	Anode Supply	8
F	Grid Bias	9
G	Mains	10
H	+Vcc for Input Aux-Ext	15
J	Safety	12
K	+Vcc for All Sensor	13
L	From Interlock n°13 to Interlock n°14	48
M	From Interlock n°21 to Remote Control Switch Card	58
N	16V	26
P	0V	27
R	16V	28
S	Filament Voltage measure	30
T	Filament Voltage measure	31
U	Filament Current measure	32
V	Filament Current measure	33
W	Digital Input Aux Interlock	6
X	Digital Input Ext Interlock	7
Y	Hours Meter	63
Z	Hours Meter	65
a	A.C. Input 12V for Motors Card	71
b	A.C. Input 12V for Motors Card	72
c	A.C. Input 21V for Microprocessor Card	69
d	A.C. Input 21V for Microprocessor Card	70
e	Not Connected	

**FIG. 17 REFERENCE VIEW**

BURDY CONNECTOR



### **FIG. 18 R.F. CIRCUIT**

A) Circuit Diagram.

**FIG. 19 MEASURE CARD**

- A) Circuit Diagram.
- B) Layout.

**FIG. 20      380V CIRCUIT**

A)    Circuit Diagram.

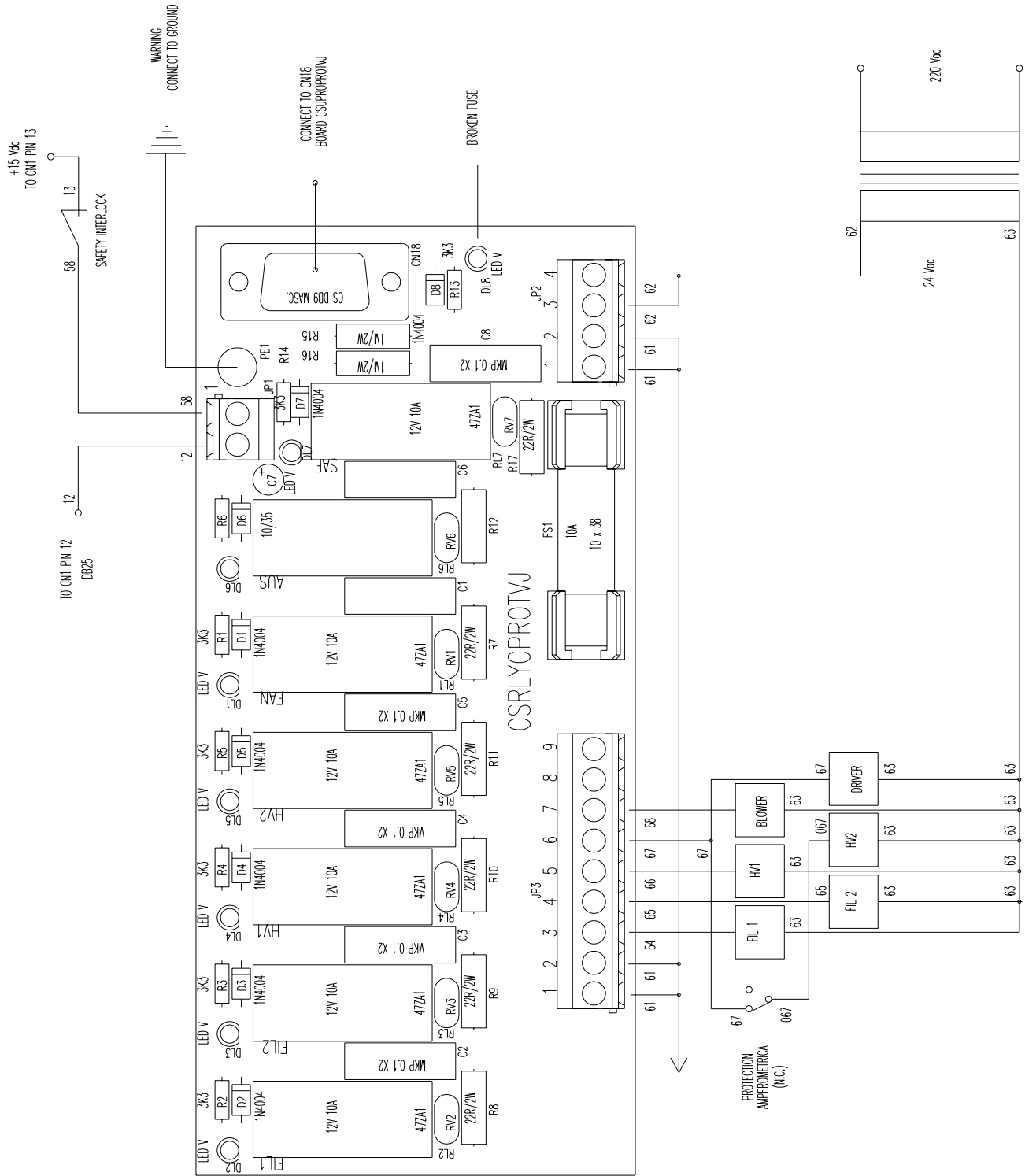
**FIG. 21            LOW TENSION CIRCUIT**

A)    Circuit Diagram.

**FIG. 22            MEASURE, ALLARMS, LOW-TENSION CIRCUIT**

A)    Circuit Diagram.

FIG. 23 POWER RELAY CARD



- B) Circuit Diagram.
- C) Reference View

**FIG. 24 REFERENCES VIEW**

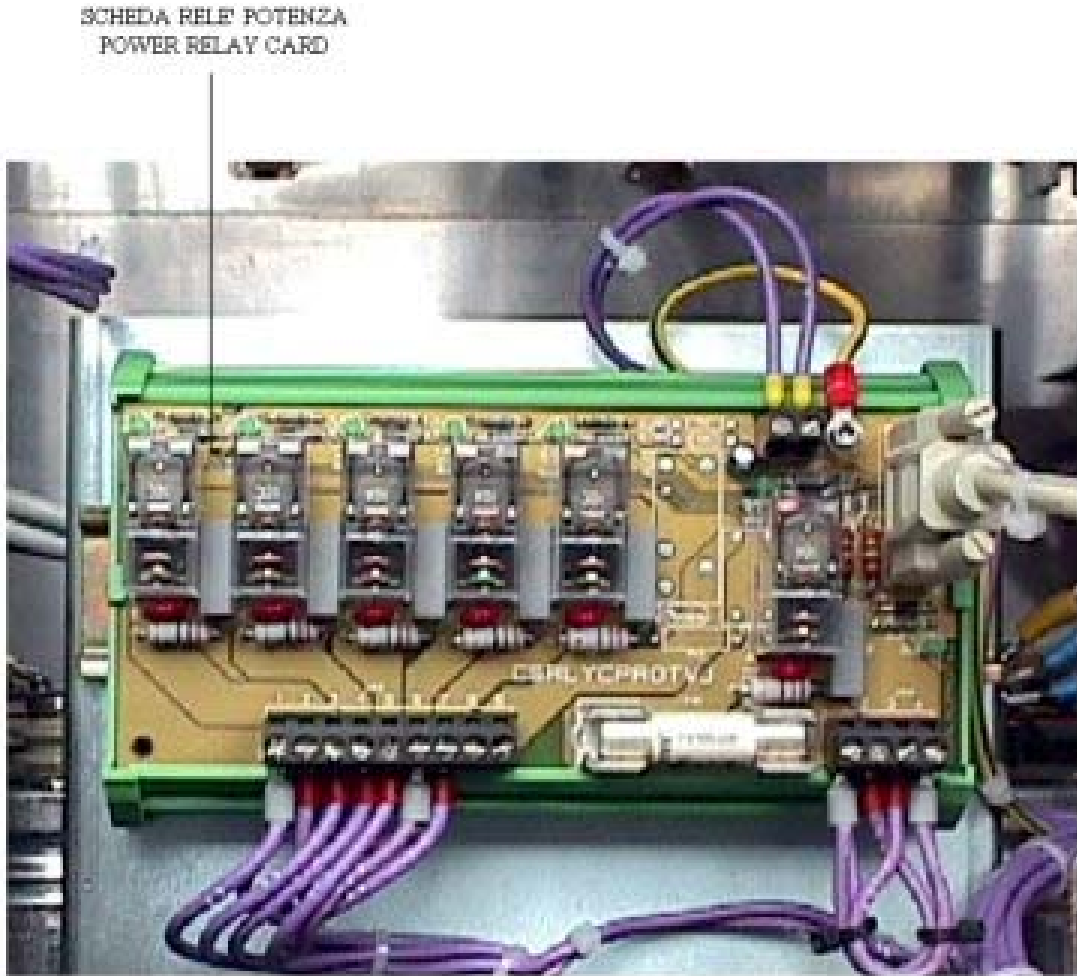
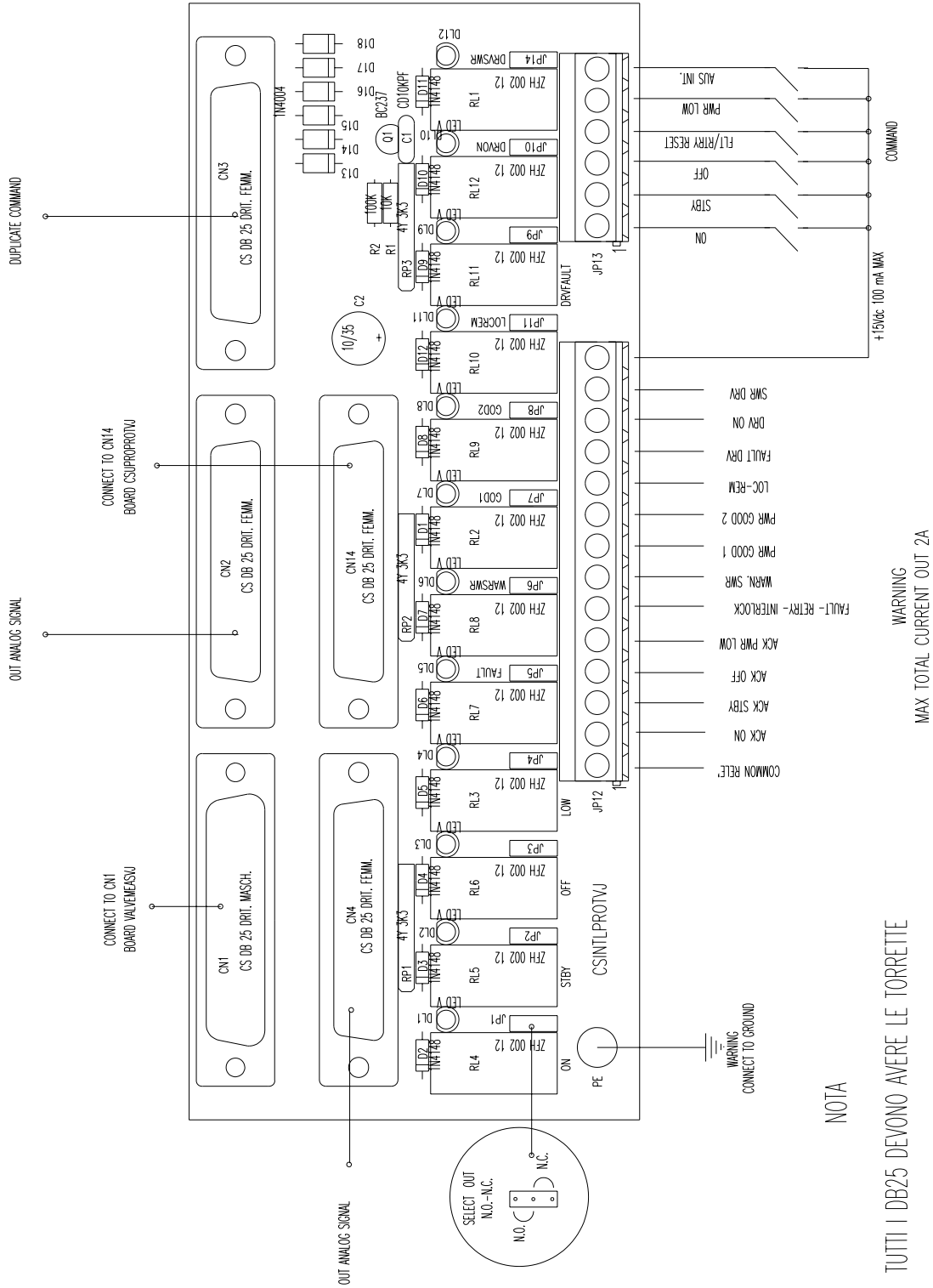




FIG. 25 INTERFACE TELEMETRY CARD



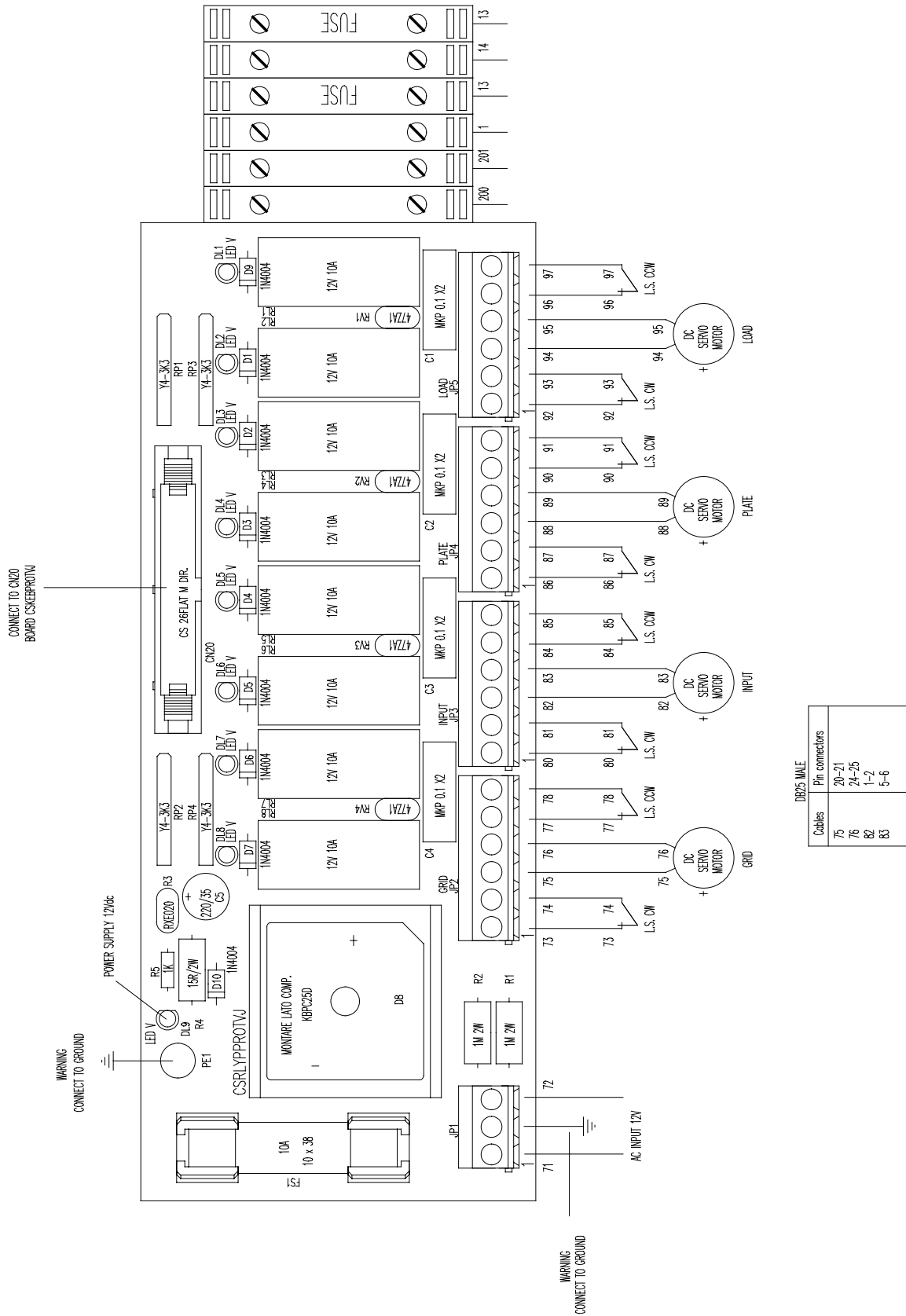
NOTA

TUTTI I DB25 DEVONO AVERE LE TORRETTE

WARNING  
MAX TOTAL CURRENT OUT 2A

A) Circuit Diagram.

FIG. 26 TUNINGS RELAY CARD

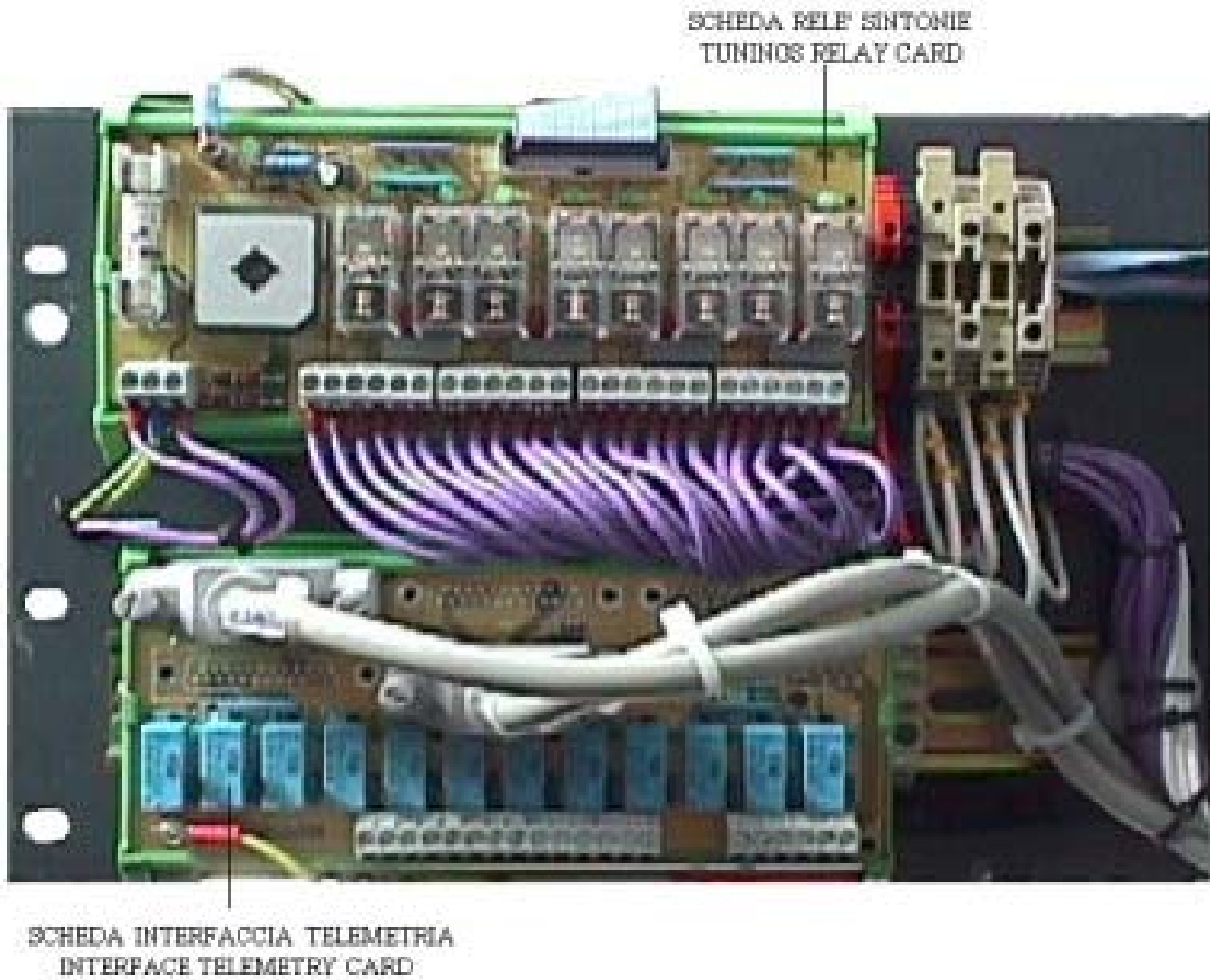


DB25 MALE

Cables	Pin connectors
75	20-21
76	24-25
82	1-2
83	5-6

- A) Circuit Diagram.
- B) Reference View.

**FIG. 27 REFERENCES VIEW**

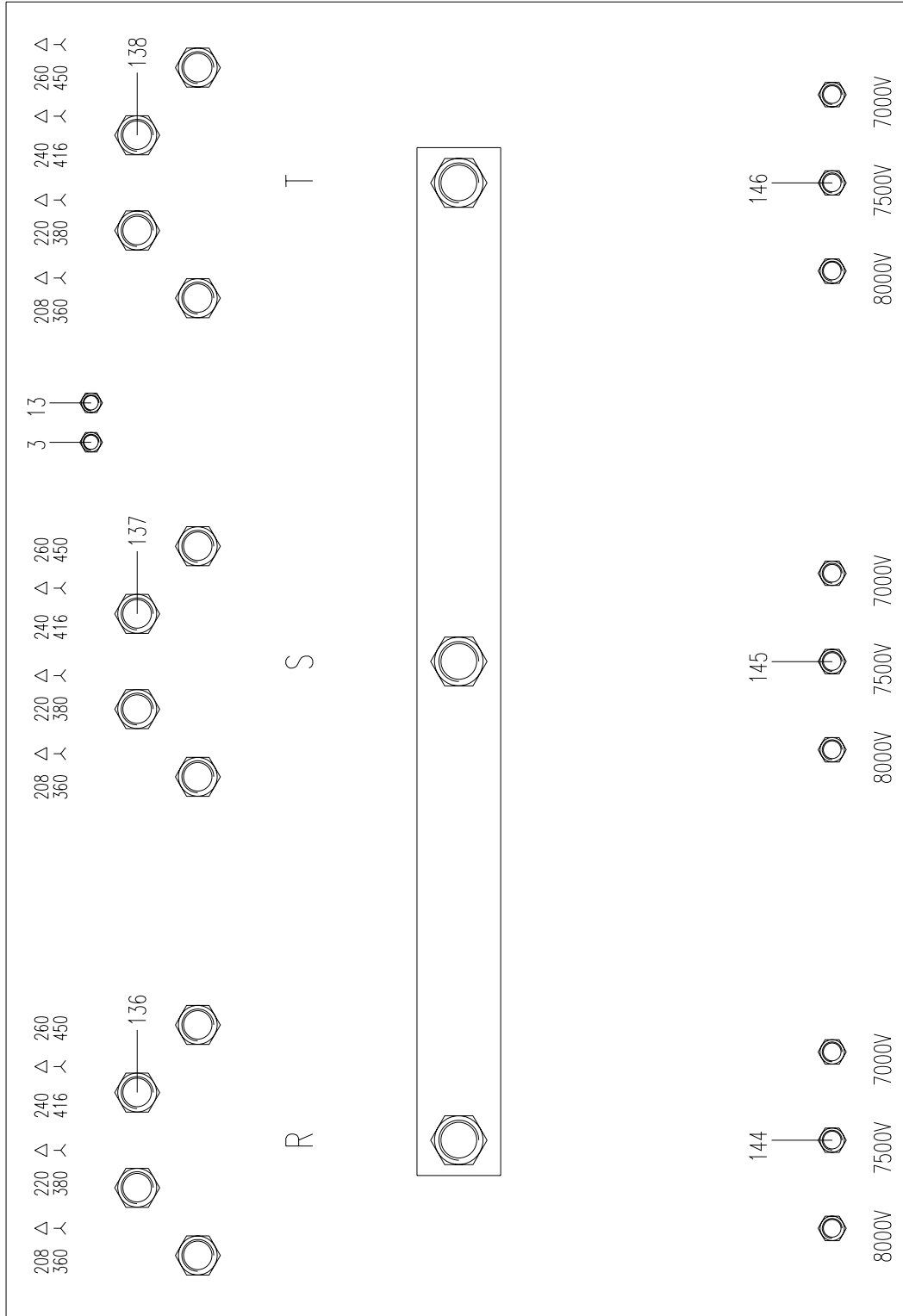


## APPENDIX B

### CONSTRUCTION DETAILS AND COMPONENTS DESCRIPTION

This appendix contains construction details, cables numeration and of some components description which composing the equipment.

FIG. 28 POWER SUPPLY P1

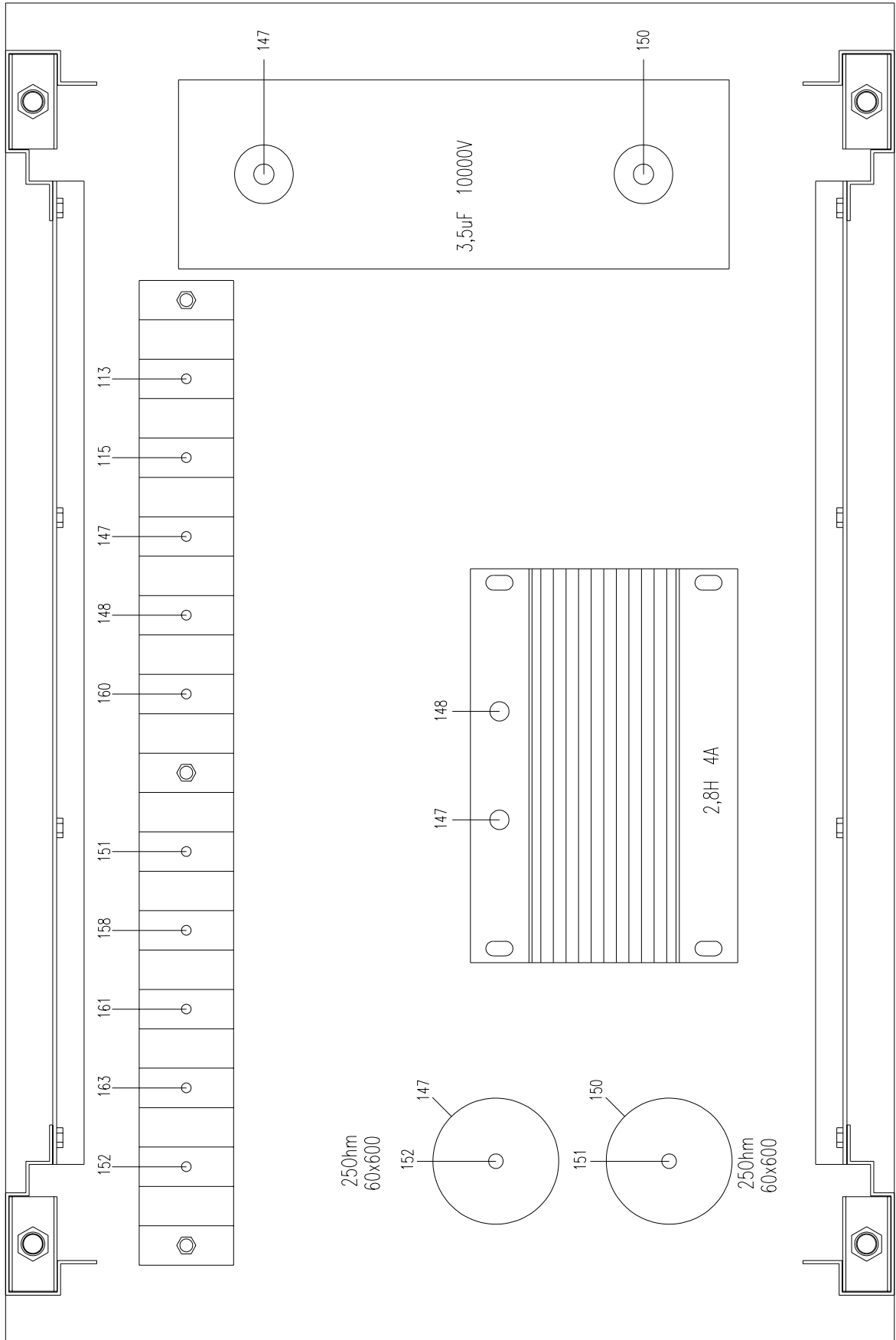


**FIG. 29 SECTIONAL VIEW OF THE POWER SUPPLY P1**



- 1) SOCKET OF THE ANODE SUPPLY TRANSFORMER

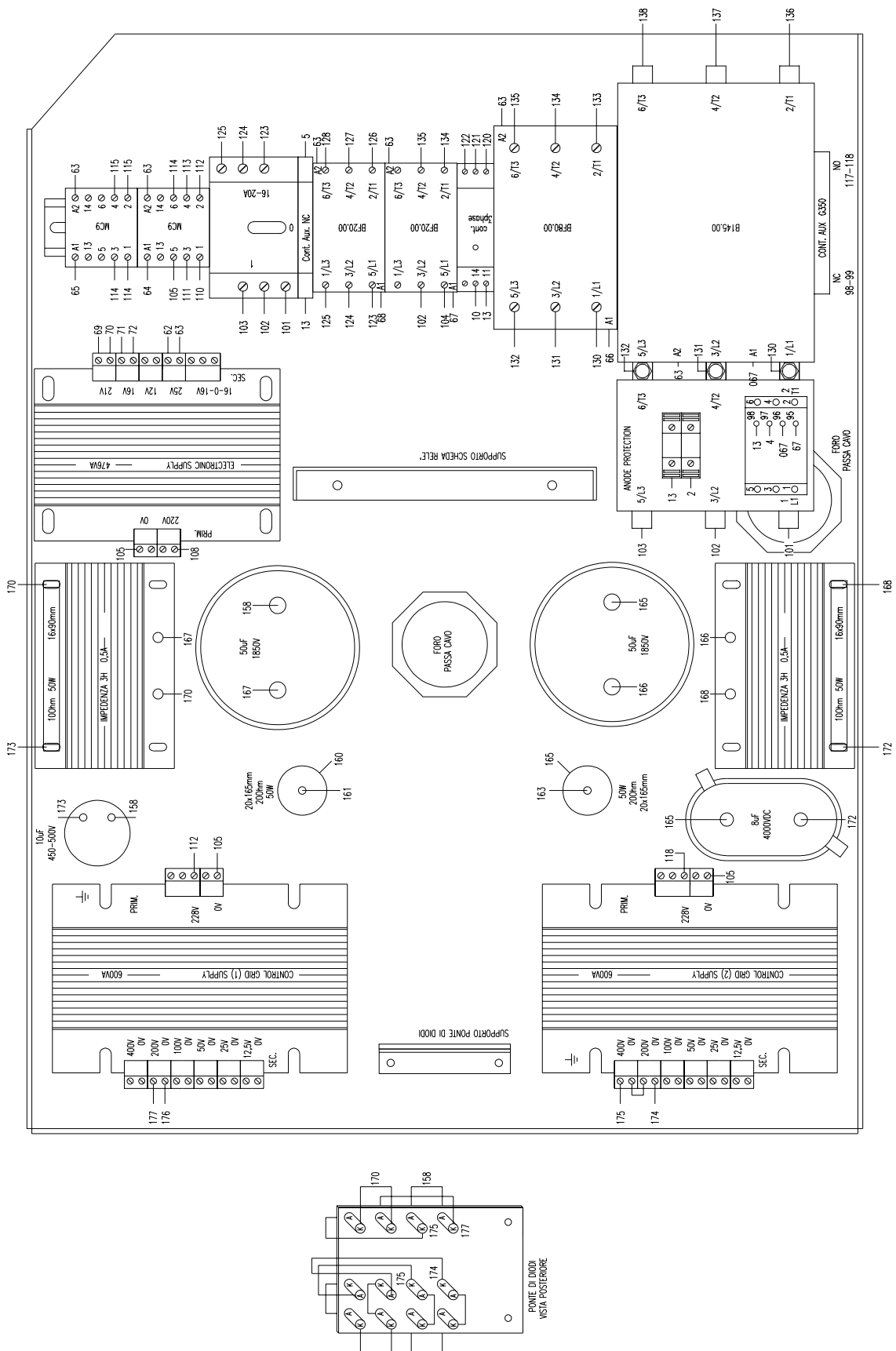
FIG. 30 POWER SUPPLY P2



**FIG. 31 SECTIONAL VIEW OF THE POWER SUPPLY P2**

- 1 BLOWER
- 2 FILAMENT TRANSFORMER
- 3 RESISTORS
- 4 INDUCTOR
- 5 POWER SOCKET
- 6 CAPACITOR

FIG. 32 PROTECTIONS PLANE



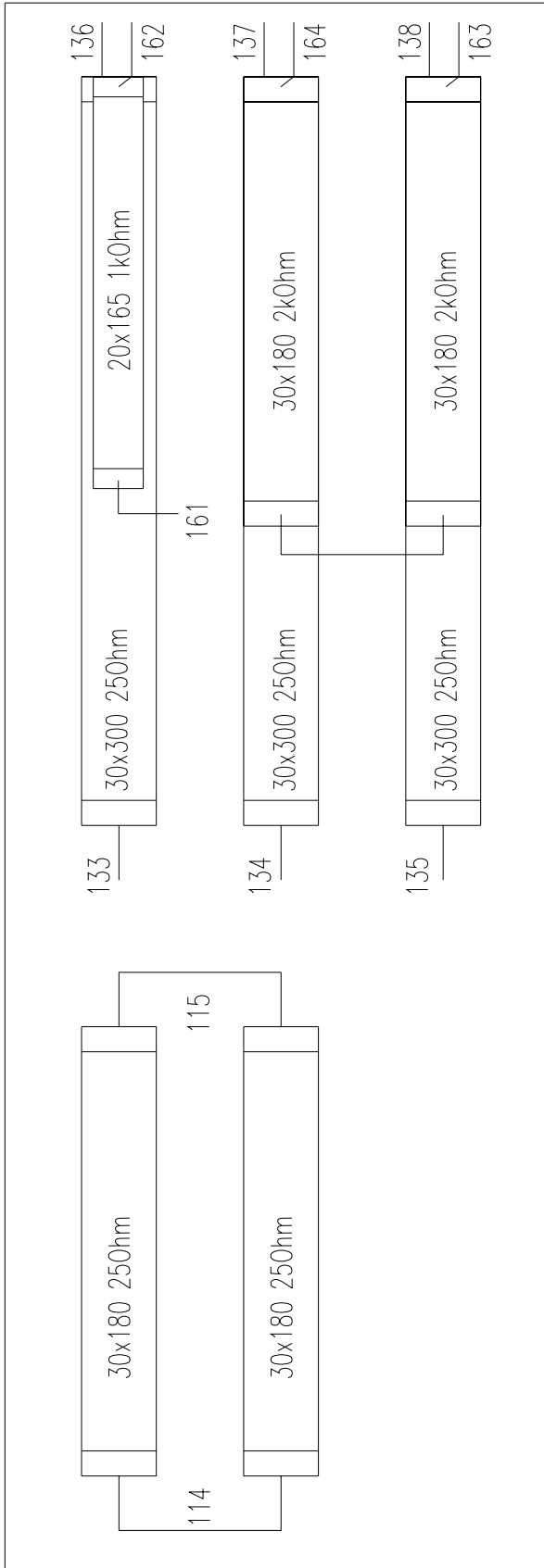


**FIG. 33      REFERENCE VIEW**



FIG. 34 RESISTORS PLANE

VISTA DA SOTTO / INFERIOR VIEW



VISTA FRONTALE / FRONT VIEW

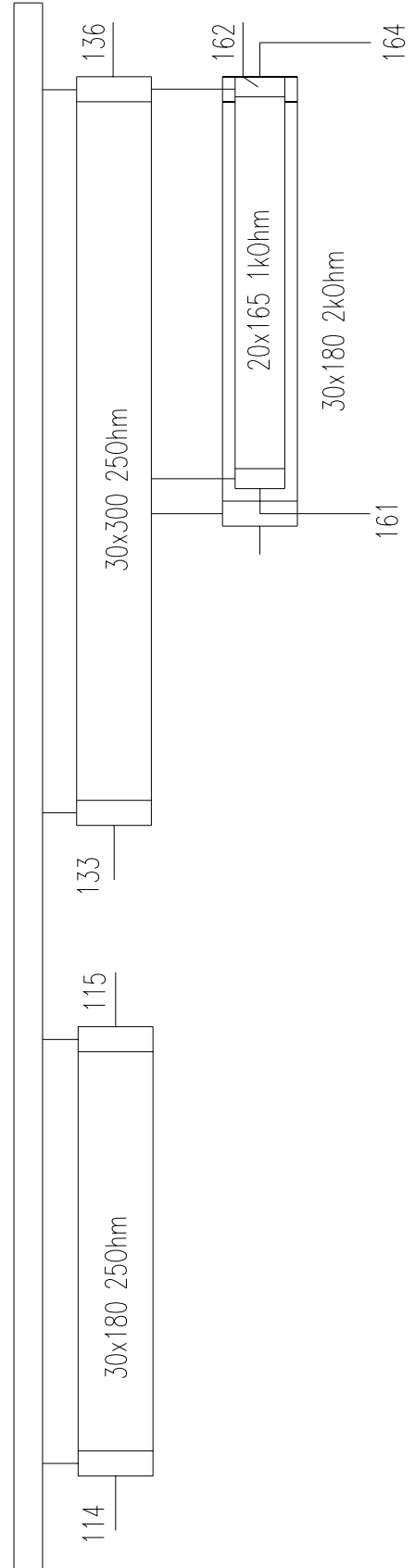
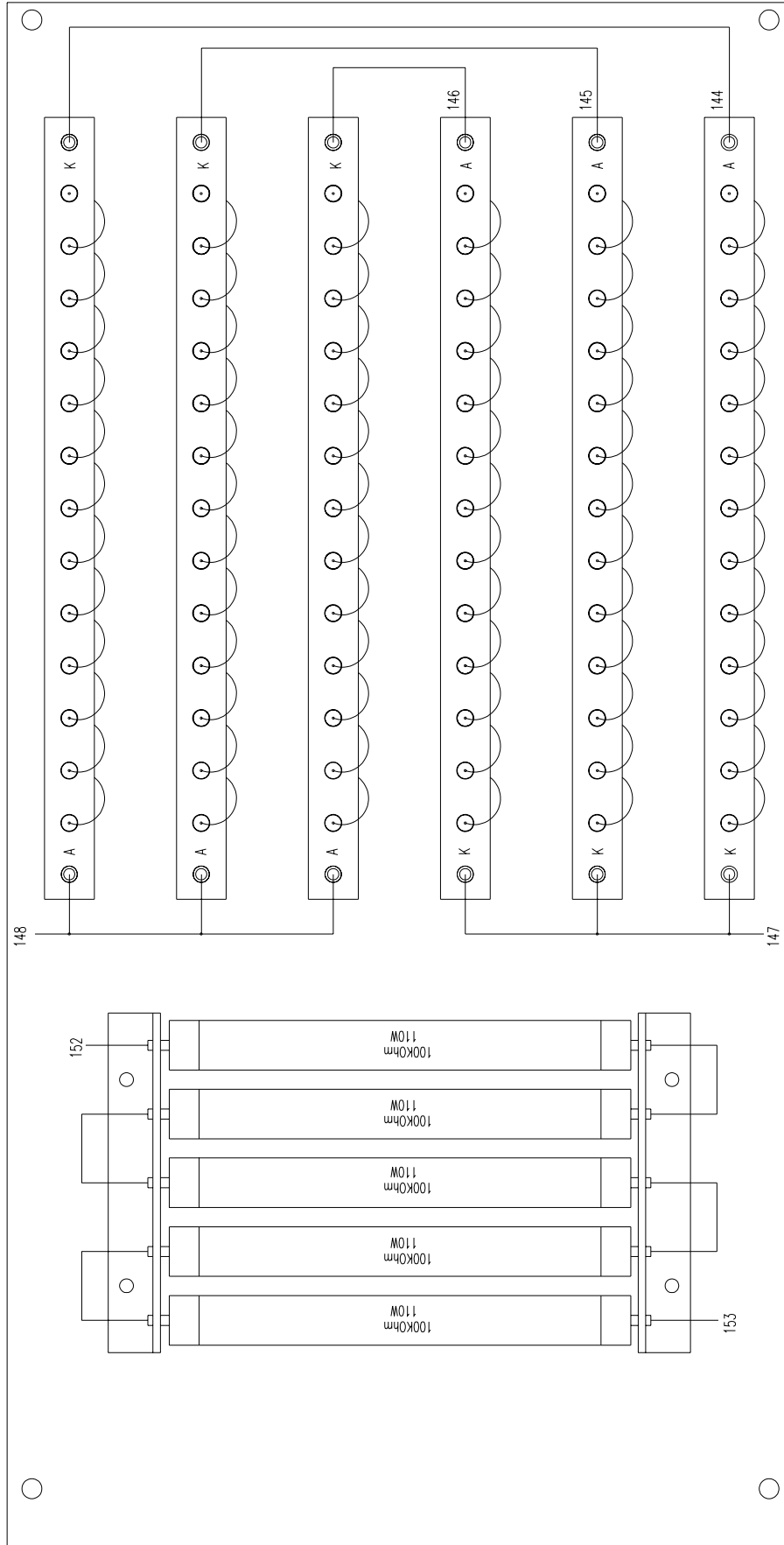


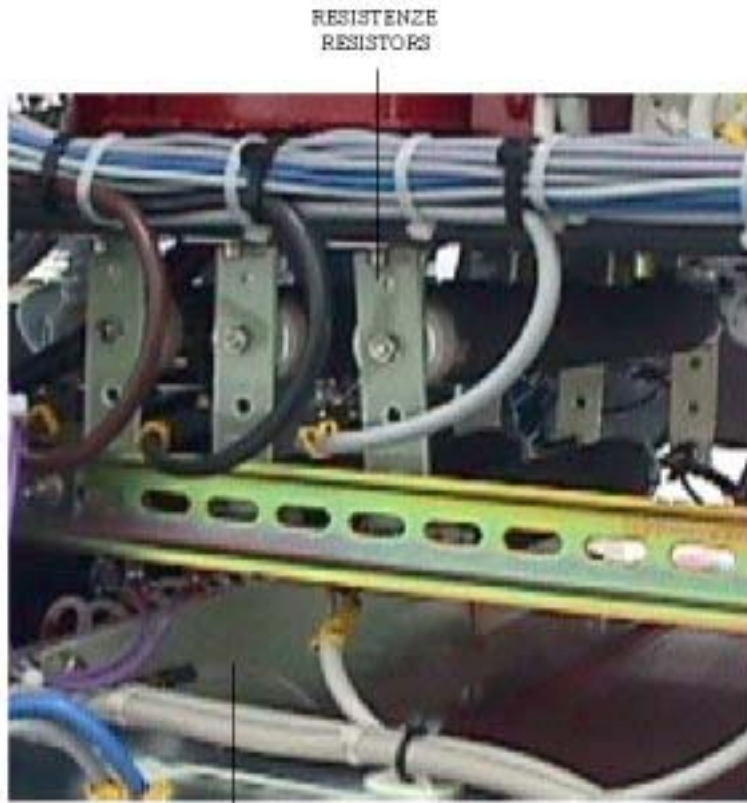
FIG. 35 RESISTORS PLANE



PONTE DI DIODI RADDRIZZATORE TENSIONE DI PLACCA  
ANODE SUPPLY BRIDGE RECTIFIER

RESISTENZE / RESISTORS

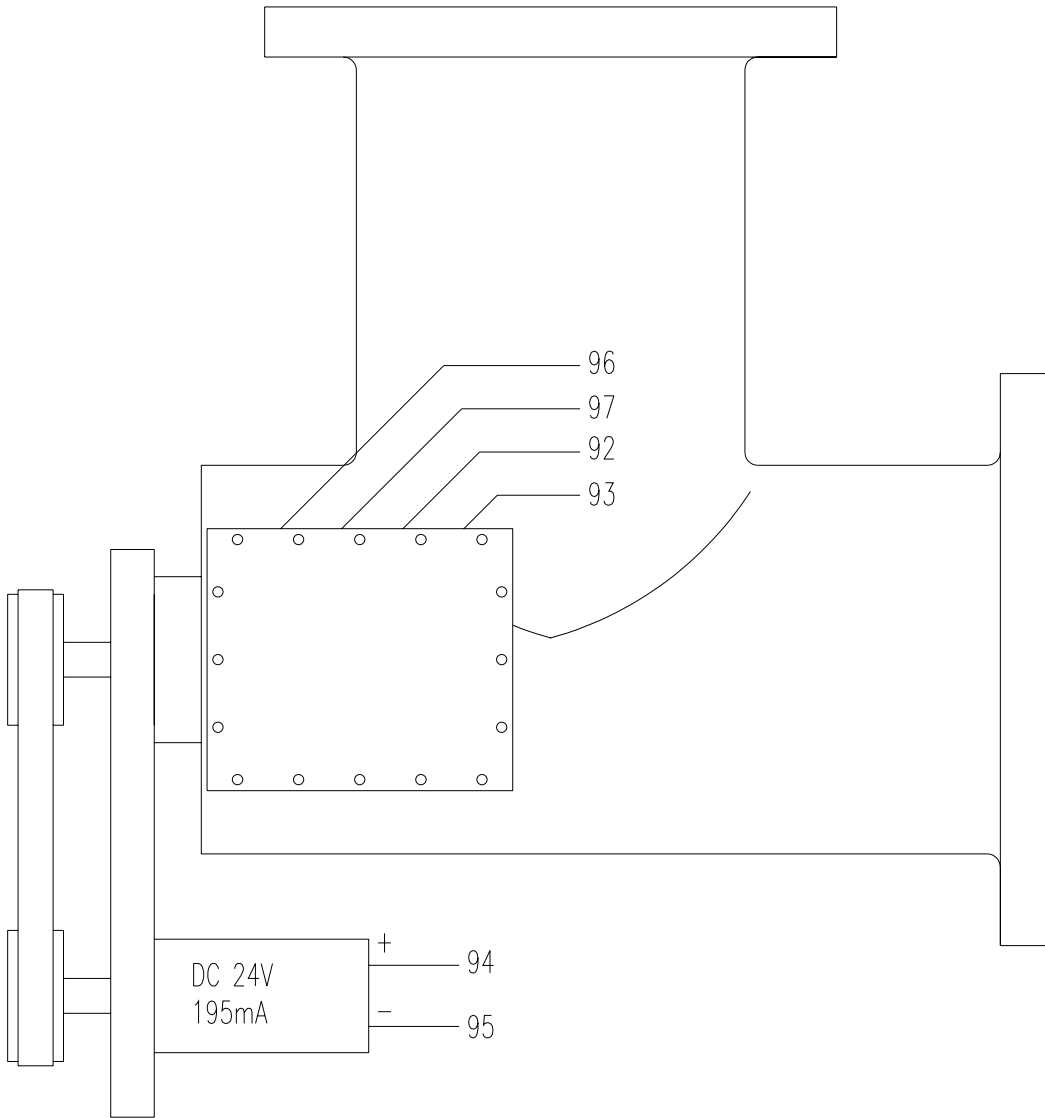
**FIG. 36 REFERENCE VIEW**



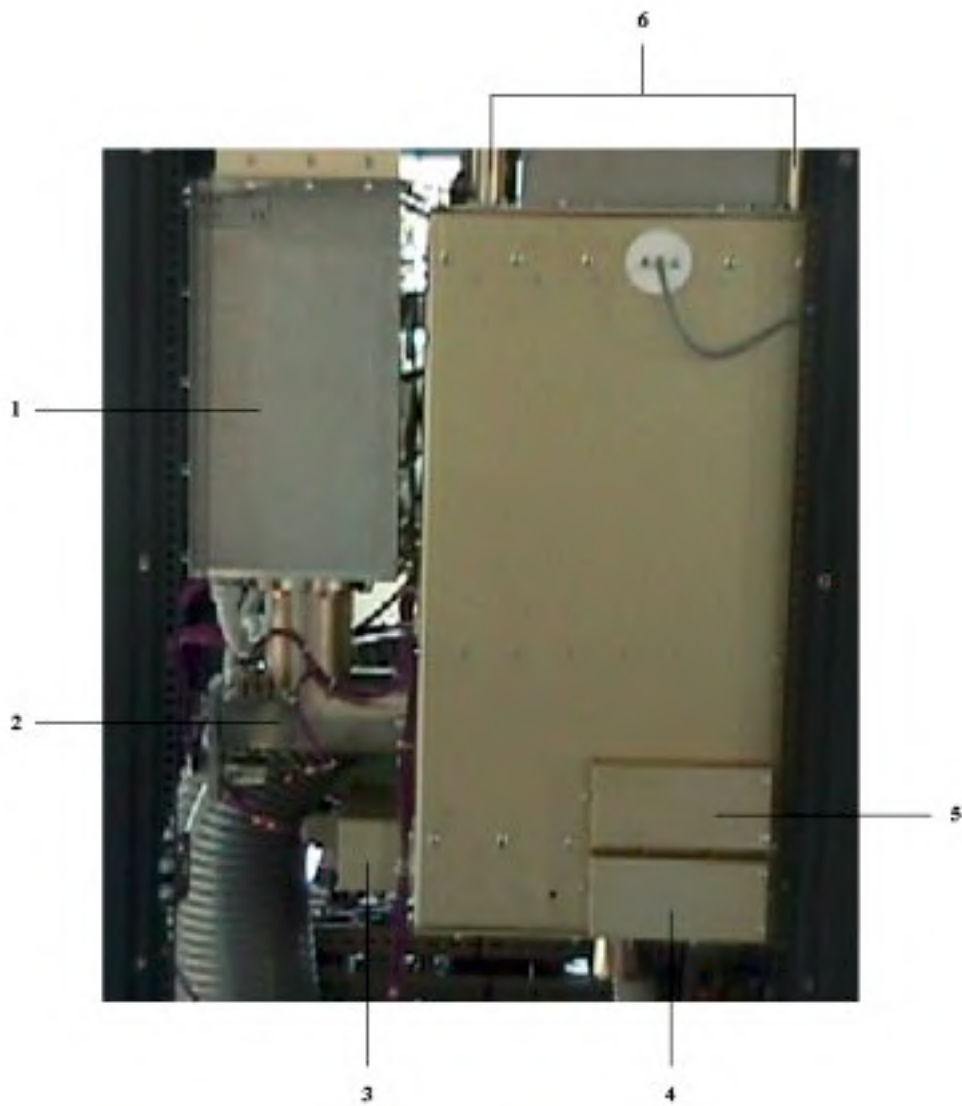
RESISTENZE  
RESISTORS

PONTE DI DIODI RADDRIZZATORE TENSIONE DI PLACCA  
ANODE SUPPLY BRIDGE RECTIFIER

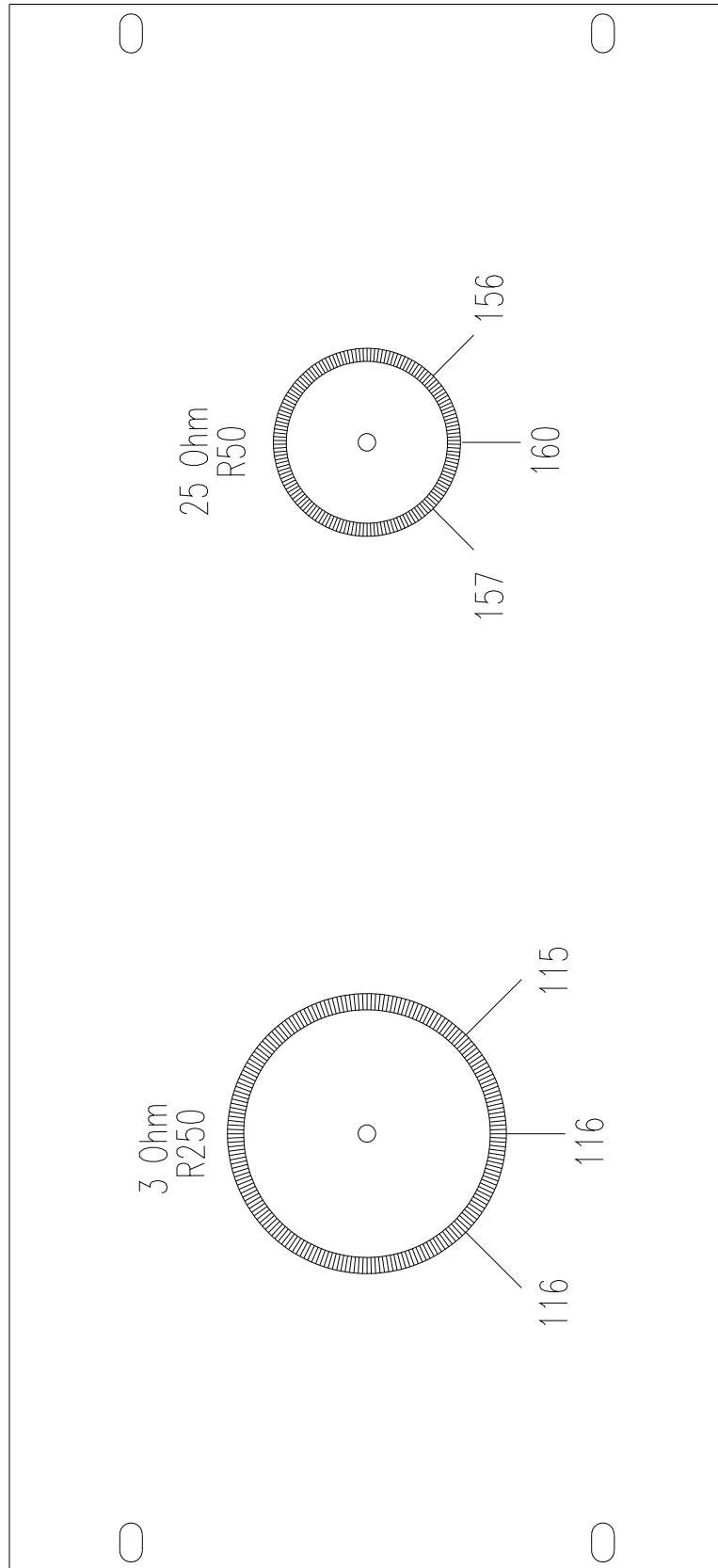
FIG. 37 TUNING MOTOR LOAD



**FIG. 38 REFERENCE VIEW**



**FIG. 39 RHEOSTATS**



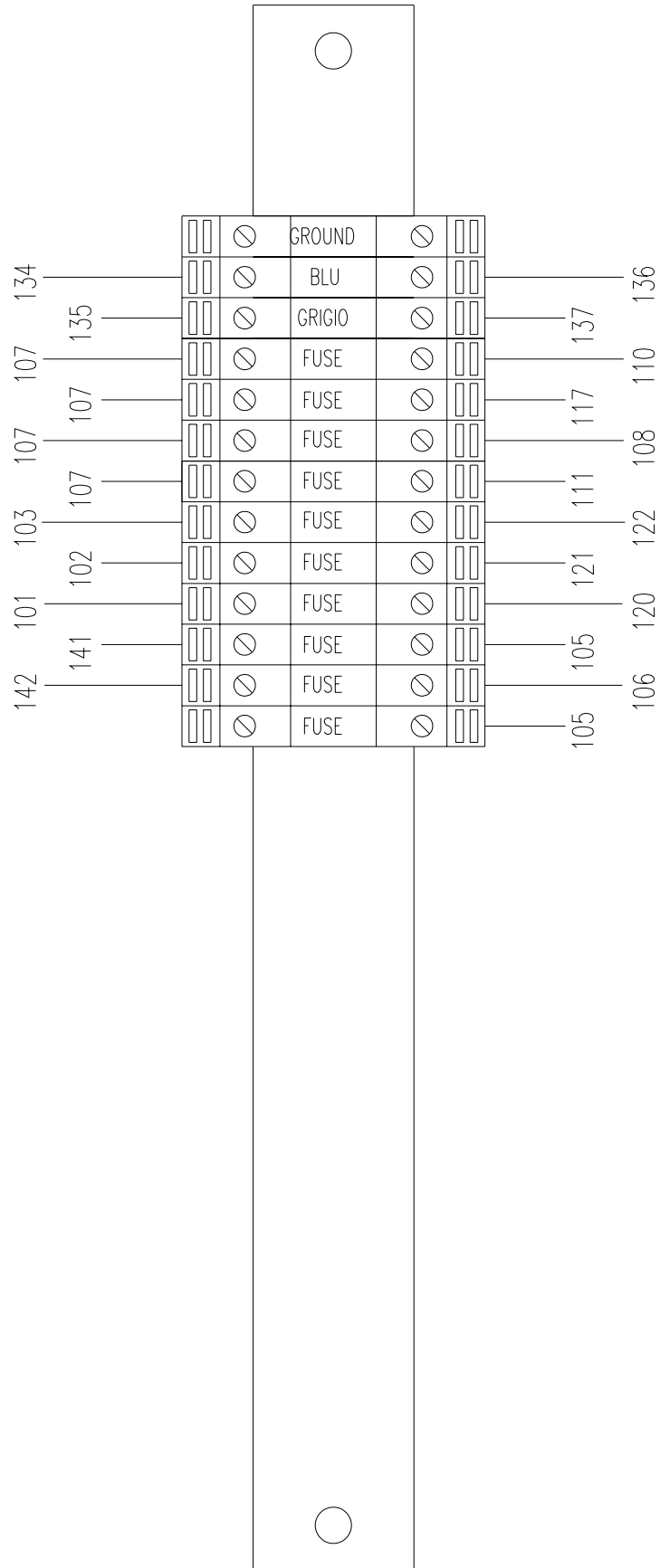
**INTERNAL VIEW**

**FIG. 40 REFERENCE VIEW**

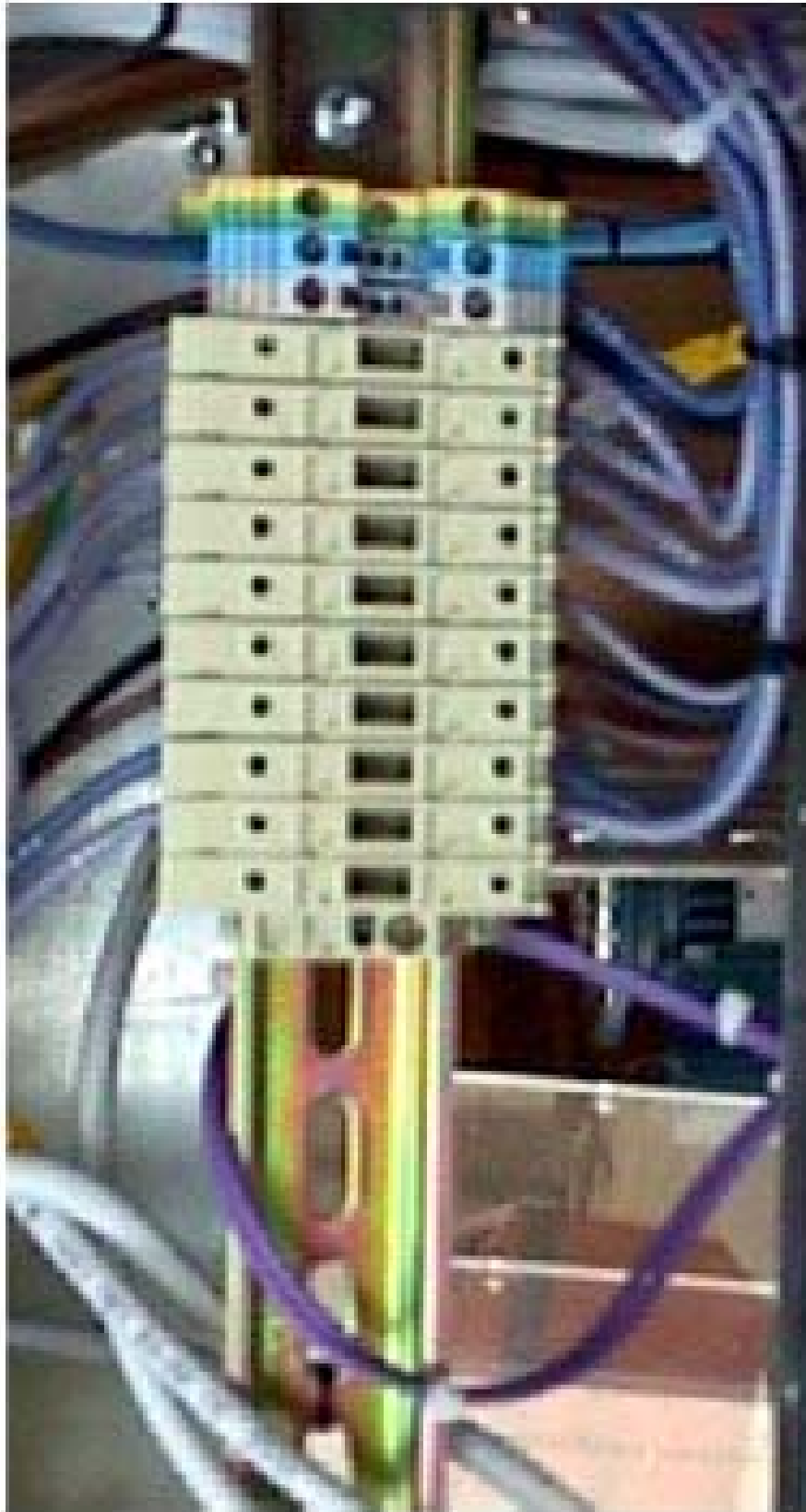




**FIG. 41 PJ1000 PROTECTION SWITCH - PROTECTION FUSES**



**FIG. 42      REFERENCE VIEW**



**FIG. 43 INPUT SOCKET**

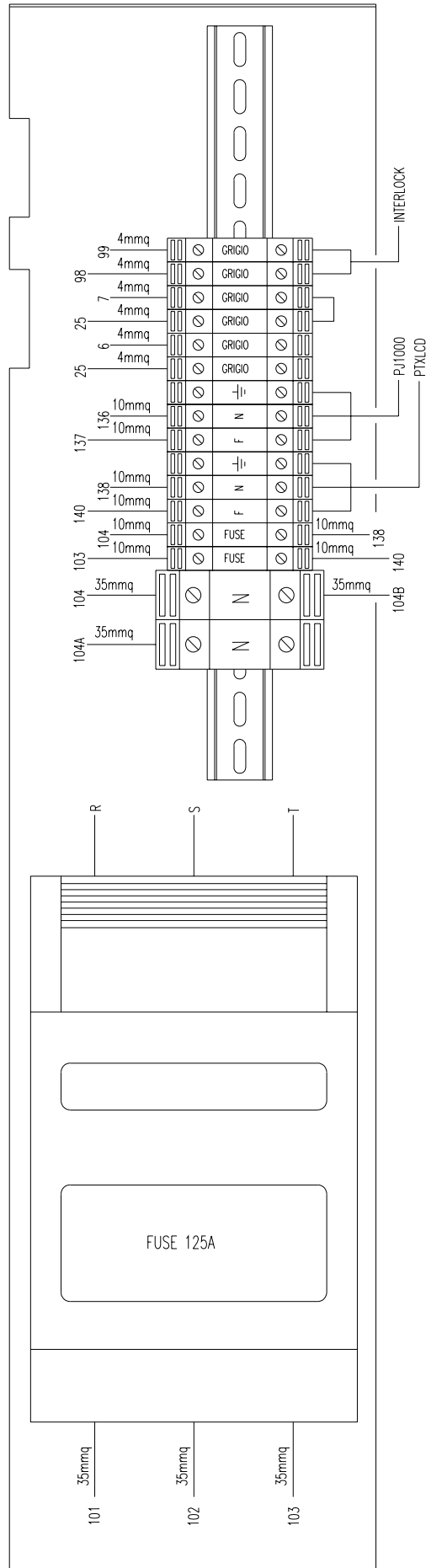


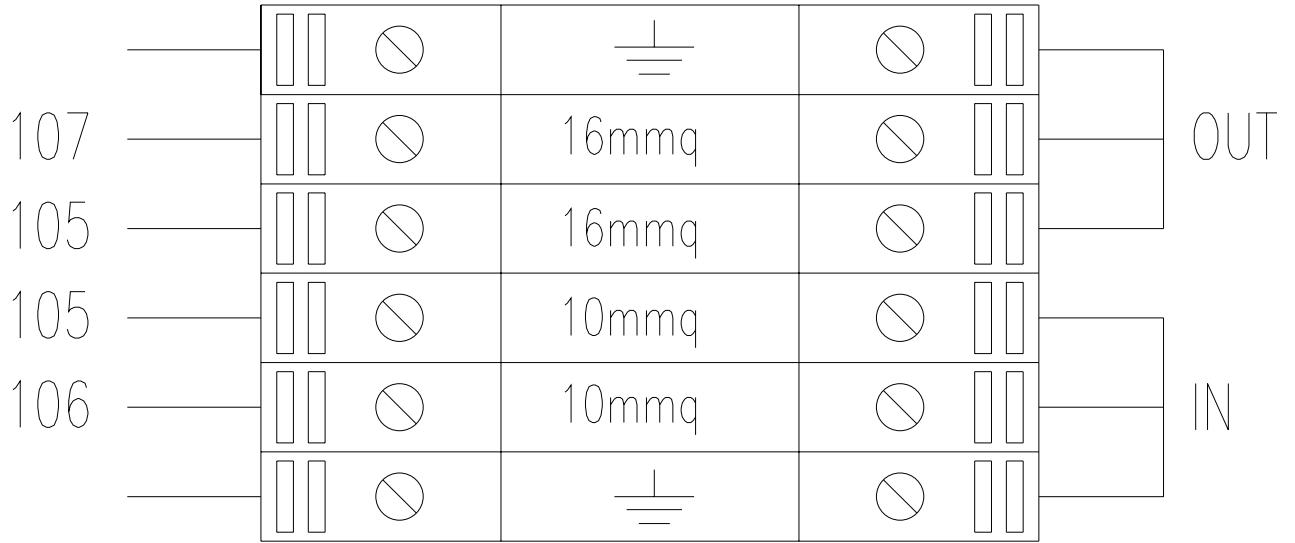
FIG. 44 REFERENCE VIEW



MORSETTIERA D'INGRESSO  
INPUT SOCKET

FUSIEMI D'INGRESSO  
INPUT FUSES

**FIG. 45 UTILITIES SOCKET**



**FIG. 46 REFERENCE VIEW**

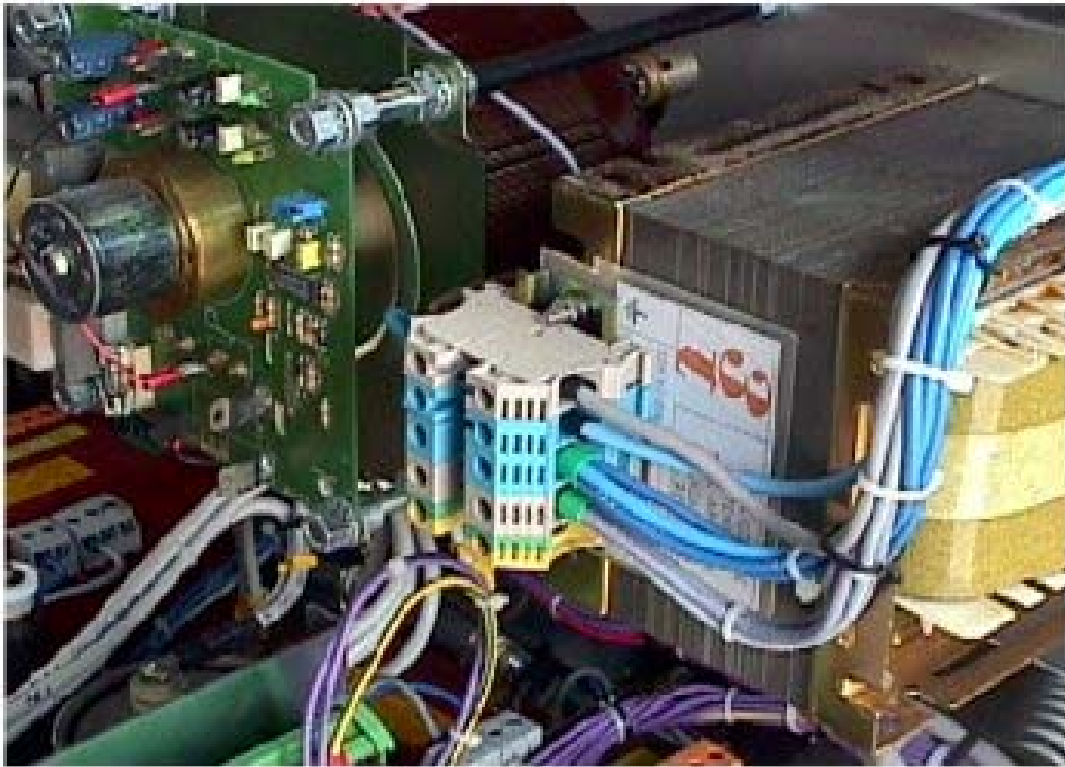
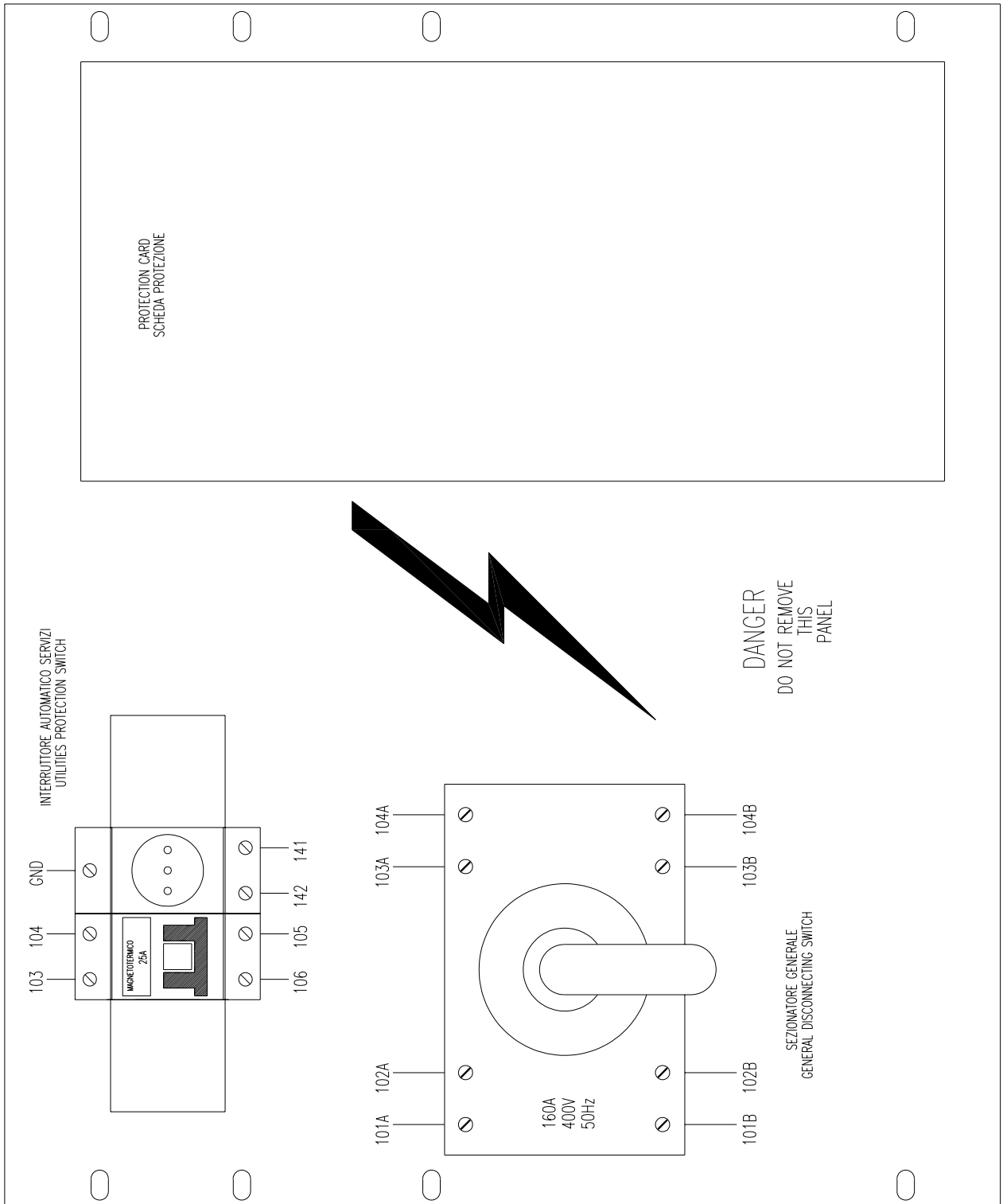


FIG. 47 HIGHT TENSION PANEL



Filament Transformer	cable n° 116 (0V) in cable n° 113 (220) in cable HT out cable HT out
Utilities Transformer	cable n° 155 (0V) in cable n° 154 (220V) in cable n° 157 HT (12V) out cable n° 158 HT (0V) out cable n° 156 HT (12V) out
Insulated Transformer	cable n° 155 (24V) in cable n° 156 (0V) in cable n° 30 (12V) out cable n° 31 (0V) out
Pressure Sensor	cable n° 11 cable n° 13
Tuning Motor Tune	cable n° 88 (+) cable n° 89 (-)
Hours Meter	cable n° 65 cable n° 63
Safety Button	cable n° 58 cable n° 57

© Copyright 2001

R.V.R. Elettronica S.p.a. (Bo)  
Via del Fonditore 2/2c - 40138 - Bologna (Italy)  
Telephone: + 39 - 51 - 6010506  
Fax: + 39 - 51 - 6011104  
e-mail: info@rvr.it  
www.rvr.it

Printed and bound in Italy. All rights reserved. No part of this manual may be reproduced or utilized in any form or by any means, electronic or mechanical, including photocopying, recording,

or by any information storage and retrieval system, without permission in writing from the publisher.