



# TEX3500LCD

USER MANUAL  
VOLUME 1



**File Name:** TEX3500LCD\_ING\_1.0.indb

**Version:** 1.0

**Date:** 24/06/2016

### Revision History

Date	Version	Reason	Editor
24/06/2016	1.0	First Version	J. H. Berti

TEX3500LCD - User Manual  
Version 1.0

© Copyright 2016  
R.V.R. Elettronica SpA  
Via del Fonditore 2/2c - 40138 - Bologna (Italia)  
Telephone: +39 051 6010506  
Fax: +39 051 6011104  
Email: info@rvr.it  
Web: www.rvr.it

All rights reserved  
Printed and bound in Italy. No part of this manual may be reproduced, memorized or transmitted in any form or by any means, electronic or mechanic, including photocopying, recording or by any information storage and retrieval system, without written permission of the copyright owner.

#### **Notification of intended purpose and limitations of product use**

This product is a FM transmitter intended for FM audio broadcasting. It utilises operating frequencies not harmonised in the intended countries of use. The user must obtain a license before using the product in intended country of use. Ensure respective country licensing requirements are complied with. Limitations of use can apply in respect of operating frequency, transmitter power and/or channel spacing.

#### **Declaration of Conformity**

Hereby, R.V.R. Elettronica SpA, declares that this FM transmitter is in compliance with the essential requirements and other relevant provisions of Directive 1999/5/EC.





# DECLARATION OF CONFORMITY

**We, the undersigned,**

Manufacturer's Name: **R.V.R. Elettronica SpA**

Manufacturer's Address: **Via del Fonditore 2/2c  
Zona Ind. Roveri  
40138 Bologna  
Italy**

**Certify and declare under our sole responsibility that the product:**

Product Description: **FM Solid State Transmitter for Broadcast service**

Models: **TEX3500LCD**

Frequency Range: **87.5 ÷ 108.0 MHz**

RF Power Output: **350 ÷ 3500 W**

**when used for its intended purpose, is in compliance with the essential requirements and other relevant provisions of Directive 1999/5/CE "R&TTE", and therefore carries the "CE" mark.**

The conformity assessment procedure referred in Article 10 and detailed in Annex III of Directive 1999/5/EC has been followed.

The following harmonized standard have been applied:

**Use of Radio Spectrum (3.2):** EN 302 018-1 V1.2.1 (2006-03) +  
EN 302 018-2 V1.2.1 (2006-03)

**ElectroMagnetic Compatibility (3.1b):** EN 301 489-1 V1.9.2 (2011-09) +  
EN 301 489-11 V1.3.1 (2006-05)

**Safety (3.1a):** EN 60215 (2016-04) +  
EN 60065 (2014-12)

The technical documentation is held at the location above, as required by the conformity assessment procedure.

Bologna, Italy, 07/07/2016

  
Ravagnani Stefano  
Technical Manager  
R.V.R. Elettronica S.p.A.



# Technical Description

		TEX3500LCD		
Parameters		U.M.	Value	Notes
<b>GENERALS</b>				
Frequency range		MHz	87.5 - 108	
Rated output power		W	3500	Continuously variable by software from 0 to maximum
Modulation type			Direct carrier frequency	
Operational Mode			Mono, Stereo, Multiplex	
Ambient working temperature		°C	-10 to +50	Whithout condensing
Frequency programmability			From software, with 10 kHz steps	
Frequency stability	WT from -10°C to 50°C	ppm	±1	
Modulation capability		kHz	150 Stereo, 180 Mono/MPX	Meets or exceeds all FCC and CCIR rules
Pre-emphasis mode		µS	0, 50 (CCIR), 75 (FCC)	selectable by rear panel dip switches
Spurious & harmonic suppression		dBc	< 62 (85 typical)	Meets or exceeds all FCC and CCIR rules
Asynchronous AM S/N ratio	Referred to 100% AM, with no de-emphasis	dB	≥ 65 (typical 70)	
Synchronous AM S/N ratio	Referred to 100% AM, FM deviation 75 kHz by 40kHz sine, without de-emphasis	dB	≥ 50 (typical 60)	
<b>MONO OPERATION</b>				
S/N FM Ratio	RMS @ ± 75 kHz peak, HPF 20Hz - LPF 23 kHz, 50 µS de-emphasis	dB	> 78 (typical 83)	
	Opk @ ± 75 kHz peak, CCIR weighted, 50 µS de-emphasis	dB	> 70	
	Opk @ ± 40 kHz peak, CCIR weighted, 50 µS de-emphasis	dB	> 67	
Frequency Response	30Hz - 15kHz	dB	better than ± 0.5 dB (typical ± 0.2)	
Total Harmonic Distortion	THD+N 30Hz - 15kHz	%	< 0.1 (Typical 0.07%)	
Intermodulation distortion	Measured with a 1 KHz, 1.3 KHz tones, 1:ratio, @ 75 kHz FM	%	< 0.02	
Transient intermodulation distortion	3.18 kHz square wave, 15 kHz sine wave @ 75 kHz FM	%	< 0.1 (typical 0.05)	
<b>MPX OPERATION</b>				
Composite S/N FM Ratio	RMS @ ± 75 kHz peak, HPF 20Hz - no LPF, 50 µS de-emphasis	dB	> 78 (typical 83)	
Frequency Response	30Hz - 53kHz	dB	± 0.2	
Total Harmonic Distortion	53kHz - 100kHz	dB	± 0.5	
	THD+N 30Hz - 53kHz	%	< 0.1	
Intermodulation distortion	THD+N 53kHz - 100kHz	%	< 0.15	
	Measured with a 1 KHz, 1.3 KHz tones, 1:ratio, @ 75 kHz FM	%	< 0.05	
Transient intermodulation distortion	3.18 kHz square wave, 15 kHz sine wave @ 75 kHz FM	%	< 0.1 (typical 0.05)	
Stereo separation	30Hz - 53kHz	dB	> 50 dB (typical 60)	
<b>STEREO OPERATION</b>				
Stereo S/N FM Ratio	RMS @ ± 75 kHz peak, HPF 20Hz - LPF 23 kHz, 50 µS de-emphasis, L & R demodulated	dB	> 73 (75 typical)	
	Opk @ ± 75 kHz peak, CCIR weighted, 50 µS de-emphasis, L & R demodulated	dB	> 65 dB	
	Opk @ ± 40 kHz peak, CCIR weighted, 50 µS de-emphasis, L & R demodulated	dB	> 58 dB	
Frequency Response	30Hz - 15kHz	dB	± 0.5	
Total Harmonic Distortion	THD+N 30Hz - 15kHz	%	< 0.05	
Intermodulation distortion	Measured with a 1 KHz, 1.3 KHz tones, 1:ratio, @ 75 kHz FM	%	≤ 0.03	
Transient intermodulation distortion	3.18 kHz square wave, 15 kHz sine wave @ 75 kHz FM	%	< 0.1 (typical 0.05)	
Stereo separation		dB	> 50 (typical 55)	
Main / Sub Ratio	30Hz - 15kHz	dB	> 40 (typical 45)	
<b>SCA OPERATION</b>				
Frequency response		dB	± 0.5	
Crosstalk to main or to stereo channel	RMS, ref @ ± 75 kHz peak, no HPF/LPF, 0µS de-emphasis, with 67 kHz tone on SCA input @ 7.5kHz FM deviation	dB	> 75 (typical 78)	
	RMS, ref @ ± 75 kHz peak, no HPF/LPF, 0µS de-emphasis, with 92 kHz tone on SCA input @ 7.5kHz FM deviation	dB	> 78 (typical 80)	
<b>POWER REQUIREMENTS</b>				
AC Power Input	AC Supply Voltage	VAC	230 +10% -15% (**)	(*) Internal switch (**) monophase (***) Three Phases Y
	AC Apparent Power Consumption	VA	4996	
	Active Power Consumption	W	4987	
	Power Factor		0.998	
	Overall Efficiency	%	Typical 70	
DC Power Input	DC Supply Voltage	VDC	Terminal Block	
	DC Current	ADC		(*)max 25W (**) max 140W
<b>MECHANICAL DIMENSIONS</b>				
Physical Dimensions	Front panel width	mm	483 (19")	19" EIA rack
	Front panel height	mm	132 (3HE)	convertire in pollici
	Overall depth	mm	675	
	Chassis depth	mm	650	escluso il pannello, esclusi i connettori, convertire in pollici
Weight	kg	about 31		
<b>VARIOUS</b>				
Cooling			Forced, with internal fan	
Acoustic Noise		dBA	< 75	
<b>AUDIO INPUTS</b>				
Left / Mono	Connector		XLR F	
	Type		Balanced	
	Impedance	Ohm	10 k or 600	Selectable by rear panel dip switches
	Input Level / Adjust	dBu	-13 to +13	continuously variable
Right	Connector		XLR F	
	Type		Balanced	
	Impedance	Ohm	10 k or 600	Selectable by rear panel dip switches
	Input Level	dBu	-13 to +13	continuously variable
MPX	Connector		BNC	
	Type		unbalanced	
	Impedance	Ohm	10 k or 50	Selectable by rear panel dip switches
	Input Level / Adjust	dBu	-13 to +13	for 75 KHz FM, externally adjustable
SCA/RDS	Connector		2 x BNC	
	Type		unbalanced	
	Impedance	Ohm	10 k	
	Input Level / Adjust	dBu	-8 to +13	for 7.5 kHz FM, externally adjustable
AES/EBU (optional)	Connector		XLR F	
	Type		Balanced	
	Impedance	Ohm	110	
	Input Level / Adjust	dBfs	0 to -10	for 7.5 kHz FM, externally adjustable
TOSLink (optional)	Connector		TOS-LINK	
	Type		Optical	
<b>OUTPUTS</b>				
RF Output	Connector		7/8" EIA	
	Impedance	Ohm	50	
RF Monitor	Connector		BNC	
	Impedance	Ohm	50	
	Output Level	dB	approx. -60	Referred to the RF output
Pilot output	Connector		BNC	For RDS and Isofrequency synchronizing purpose
	Impedance	Ohm	> 5 k	
	Output Level	Vpp	1	
<b>AUXILIARY CONNECTIONS</b>				
Interlock	Connector		2 x BNC	Input and output for remote power inhibition (short is RF off)
Service	Connector		DB9 F	Factory reserved for firmware program
Remote Interface	Connector		DB15F	IIC + 5 analog / digital inputs, 5 analog / digital outputs
<b>FUSES</b>				
On Mains			3 External F 10 T - 6 x 30 mm	
On services				
On PA Supply			4 Internal F 32 A 10 x 38 mm	
On Driver Supply				
<b>HUMAN INTERFACES</b>				
Input device			4 pushbutton	
Display			Alphanumerical LCD - 2 x 16	

# Table of Contents

<b>1.</b>	<b>Preliminary Instructions</b>	<b>1</b>
<b>2.</b>	<b>Warranty</b>	<b>1</b>
<b>3.</b>	<b>First Aid</b>	<b>2</b>
3.1	Treatment of electrical shocks	2
3.2	Treatment of electrical Burns	2
<b>4.</b>	<b>General Description</b>	<b>3</b>
4.1	Unpacking	3
4.2	Features	3
4.3	Frontal Panel Description	5
4.4	Rear Panel Description	6
4.5	Connectors Pinouts	7
<b>5.</b>	<b>Quick guide for installation and use</b>	<b>9</b>
5.1	Preparation	9
5.2	First power-on and setup	11
5.3	Operation	13
5.4	Management Firmware	15
5.5	Optional functions	20
<b>6.</b>	<b>Module identification</b>	<b>23</b>
6.1	Identification of the Modules	23
<b>7.</b>	<b>Working Principles</b>	<b>24</b>
7.1	Panel card	24
7.2	Main board	24
7.3	Telemetry card	25
7.4	Power supply	25
7.5	Power Amplifier	25
7.6	Bias card	26
7.7	Low Pass Filter card	26
7.8	Driver card	26

*This page was intentionally left blank*



**IMPORTANT**

The symbol of lightning inside a triangle placed on the product, evidences the operations for which is necessary gave it full attention to avoid risk of electric shocks.



The symbol of exclamation mark inside a triangle placed on the product, informs the user about the presence of instructions inside the manual that accompanies the equipment, important for the efficacy and the maintenance (repairs).

## 1. Preliminary Instructions

### • General Warnings

This equipment should only be operated, installed and maintained by "trained" or "qualified" personnel who are familiar with risks involved in working on electric and electronic circuits. "Trained" means personnel who have technical knowledge of equipment operation and who are responsible for their own safety and that of other unqualified personnel placed under their supervision when working on the equipment. "Qualified" means personnel who are trained in and experienced with equipment operation and who are responsible for their own safety and that of other unqualified personnel placed under their supervision when working on the equipment.

**⚡ WARNING: Residual voltage may be present inside the equipment even when the ON/OFF switch is set to Off. Before servicing the equipment, disconnect the power cord or switch off the main power panel and make sure the safety earth connection is connected. Some service situations may require inspecting the equipment with live circuits. Only trained and qualified personnel may work on the equipment live and shall be assisted by a trained person who shall keep ready to disconnect power supply at need.**

R.V.R. Elettronica S.p.A. shall not be liable for injury to persons or damage to property resulting from improper use or operation by trained/untrained and qualified/unqualified persons.

**⚡ WARNING: The equipment is not water resistant. Any water entering the enclosure might impair proper operation. To prevent the risk of electrical shock or fire, do not expose this equipment to rain, dripping or moisture.**

Please observe local codes and fire prevention rules when installing and operating this equipment.

**⚡ WARNING: This equipment contains exposed live parts involving an electrical shock hazard. Always disconnect power supply before removing any covers or other parts of the equipment.**

Ventilation slits and holes are provided to ensure reliable operation and prevent overheating; do not obstruct or cover these slits. Do not obstruct the ventilation slits under any circumstances. The product must not be incorporated in a rack unless adequate ventilation is provided or the manufacturer's instructions are followed closely.

**⚠ WARNING: This equipment can radiate radiofrequency energy and, if not installed in compliance with manual instructions and applicable regulations, may cause interference with radio communications.**

**⚠ WARNING: This equipment is fitted with earth connections both in the power cord and for the chassis. Make sure both are properly connected.**

Operation of this equipment in a residential area may cause radio interference, in which case the user may be required to take adequate measures.

The specifications and data contained herein are provided for information only and are subject to changes without prior notice. R.V.R. Elettronica S.p.A. disclaims all warranties, express or implied. While R.V.R. Elettronica S.p.A. attempts to provide accurate information, it cannot accept responsibility or liability for any errors or inaccuracies in this manual, including the products and the software described herein. R.V.R. Elettronica S.p.A. reserves the right to make changes to equipment design and/or specifications and to this manual at any time without prior notice.

### • Notice concerning product intended purpose and use limitations.

This product is a radio transmitter suitable for frequency-modulation audio radio broadcasting. Its operating frequencies are not harmonised in designated user countries. Before operating this equipment, user must obtain a licence to use radio spectrum from the competent authority in the designated user country. Operating frequency, transmitter power and other characteristics of the transmission system are subject to restrictions as specified in the licence.

## 2. Warranty

La R.V.R. Elettronica S.p.A. warrants this product to be free from defects in workmanship and its proper operation subject to the limitations set forth in the supplied Terms and Conditions. Please read the Terms and Conditions carefully, as purchase of the product or acceptance of the order acknowledgement imply acceptance of the Terms and Conditions. For the latest updated terms and conditions, please visit our web site at WWW.RVR.IT. The web site may be modified, removed or updated for any reason whatsoever without prior notice. The warranty will become null and void in the event the product enclosure is opened, the product is physically damaged, is repaired by unauthorised persons or is used for purposes other than its intended use, as well as in the event of improper use, unauthorised changes or neglect. In the event a defect is found, follow this procedure:

- 1 Contact the seller or distributor who sold the equipment; provide a description of the problem or malfunction for the event a quick fix is available.

Sellers and Distributors can provide the necessary information to troubleshoot the most frequently encountered problems. Normally, Sellers and Distributors can offer a faster repair service than the Manufacturer would. Please note that Sellers can pinpoint problems due to wrong installation.

- 2 If your Seller cannot help you, contact R.V.R. Elettronica S.p.A. and describe the problem; if our staff deems it appropriate, you will receive an authorisation to return the equipment along with suitable instructions;
- 3 When you have received the authorisation, you may return the unit. Pack the unit carefully before shipment; use the original packaging whenever possible and seal the package perfectly. The customer bears all risks of loss (i.e., R.V.R. shall not be liable for loss or damage) until the package reaches the R.V.R. factory. For this reason, we recommend insuring the goods for their full value. Returns must be sent on a C.I.F. basis (PREPAID) to the address stated on the authorisation as specified by the R.V.R. Service Manager.



Units returned without a return authorisation may be rejected and sent back to the sender.

- 4 Be sure to include a detailed report mentioning all problems you have found and copy of your original invoice (to show when the warranty period began) with the shipment.

Please send spare and warranty replacement parts orders to the address provided below. Make sure to specify equipment model and serial number, as well as part description and quantity.



R.V.R. Elettronica S.p.A.  
Via del Fonditore, 2/2c  
40138 BOLOGNA ITALY  
Tel. +39 051 6010506

## 3. First Aid

All personnel engaged in equipment installation, operation and maintenance must be familiar with first aid procedures and routines.

### 3.1 Electric shock treatment

#### 3.1.1 If the victim is unconscious

Follow the first aid procedures outlined below.

- Lay the victim down on his/her back on a firm surface.
- the neck and tilt the head backwards to free the airway system (**Figure 1**).

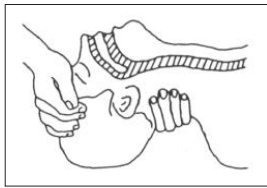

Figure 1

- If needed, open the victim's mouth and check for breathing.
- If there is no breathing, start artificial respiration without delay (**Figure 2**) as follows: tilt the head backwards, pinch the nostrils, seal your mouth around the victim's mouth and give four fast rescue breaths.



Figure 2

- Check for heartbeat (**Figure 3**); if there is no heartbeat, begin chest compressions immediately (**Figure 4**) placing your hands in the centre of the victim's chest (**Figure 5**).

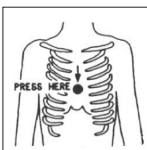
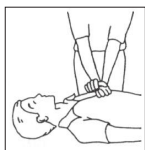
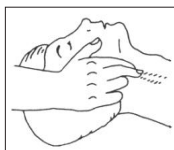

Figure 3

Figure 4

Figure 5

- One rescuer: give 2 quick rescue breaths after each 15 compressions.
- Two rescuers: one rescue breath after each 5 compressions.

- Do not stop chest compressions while giving artificial breathing.
- Call for medical help as soon as possible.

#### 3.1.2 If the victim is conscious

- Cover victim with a blanket.
- Try to reassure the victim.
- Loosen the victim's clothing and have him/her lie down.
- Call for medical help as soon as possible.

### 3.2 Treatment of electric burns

#### 3.2.1 Large burns and broken skin

- Cover affected area with a clean cloth or linen.
- Do not break any blisters that have formed; remove any clothing or fabric that is stuck to the skin; apply adequate ointment.
- Administer adequate treatment for the type of accident.
- Get the victim to a hospital as quickly as possible.
- Elevate arms and legs if injured.

If medical help is not available within an hour, the victim is conscious and is not retching, administer a solution of table salt and baking soda (one teaspoon of table salt to half teaspoon of baking soda every 250 ml of water).

Have the victim slowly drink half a glass of solution for four times during a period of 15 minutes.

Stop at the first sign of retching.

Do not administer alcoholic beverages.

#### 3.2.2 Minor Burns

- Apply cold (not ice cold) strips of gauze or dress wound with clean cloth.
- Do not break any blisters that have formed; remove any clothing or fabric that is stuck to the skin; apply adequate ointment.
- If needed, have the victim change into clean, dry clothing.
- Administer adequate treatment for the type of accident.
- Get the victim to a hospital as quickly as possible.
- Elevate arms and legs if injured.



## 4. General Description

**TEX3500LCD** is a compact **FM transmitter** manufactured by R.V.R. Elettronica SpA for audio radio broadcasting in the 87.5 to 108 MHz band in 10kHz steps, featuring adjustable RF output up to 3500 W, respectively, under 50 Ohm standard load.

**TEX3500LCD** is designed to being contained into a 19" rack box of 3HE.

### 4.1 Unpacking

The package contains:

- 1 **TEX3500LCD**
- 1 User Manual

The following accessories are also available from Your R.V.R. Dealer:

- **Accessories, spare parts and cables**

### 4.2 Features

The overall efficiency of **TEX3500LCD** is better than 70% across the bandwidth, for this reason are part of RVR Green Line family.

This performance characteristic is guaranteed in a range between +0.25 dB and -3 dB (+5% and -50%) referred to the nominal power of the equipment: for example from 1750W to 3675W in case of **TEX3500LCD**; outside these limits the equipment is able to work properly but can not guarantee an efficiency of 70%.

This transmitter incorporate a low-pass filter to keep harmonics below the limits provided for by international standards (CCIR, FCC or ETSI) and can be connected directly to the antenna.

Two major features of **TEX3500LCD** is compact design and user-friendliness. Another key feature is its modular-concept design: the different functions are performed by modules with most connections achieved through male and female connectors or through flat cables terminated by connectors. This design facilitates maintenance and module replacement.

The RF power section of **TEX3500LCD** uses one LD-MOSFET module delivering up to 900W output power.



Operating frequency stability is ensured by a temperature-compensated reference oscillator and is maintained by a PLL (Phase Locked Loop) system. The transmitter will go into frequency lock within 30 seconds after power-on.

**TEX3500LCD** can operate throughout the frequency bank with no need for calibration or set-up.

An LCD on the front panel and a push-button panel provide for user interfacing with the microprocessor control system, which implements the following features:

- Output power setup.
- Working frequency setup.
- Power output enable/disable.
- User-selectable threshold settings for output power alarm (Power Good feature)
- Measurement and display of transmitter operating parameters.
- Communication with external devices such as programming or telemetry systems via RS232 serial interface or I<sup>2</sup>C.

Four LEDs on the front panel provide the following status indications: **ON**, **LOCK**, **FOLDBACK** and **RF MUTE**.

The transmitter management firmware is based on a menu system. User has four navigation buttons available to browse submenus: **ESC** ,  ,  , and **ENTER**.

The rear panel features the mains input connectors, as well as audio input connectors and RF output connector, telemetry connector, protection fuses and two inputs for signals modulated onto subcarriers by suitable external coders, such as RDS (Radio Data System) signals commonly used in Europe.



**IMPORTANT:** *The machine works in three-phase, with connection to star point, and can also be used in single-phase.*

### 4.3 Frontal Panel Description

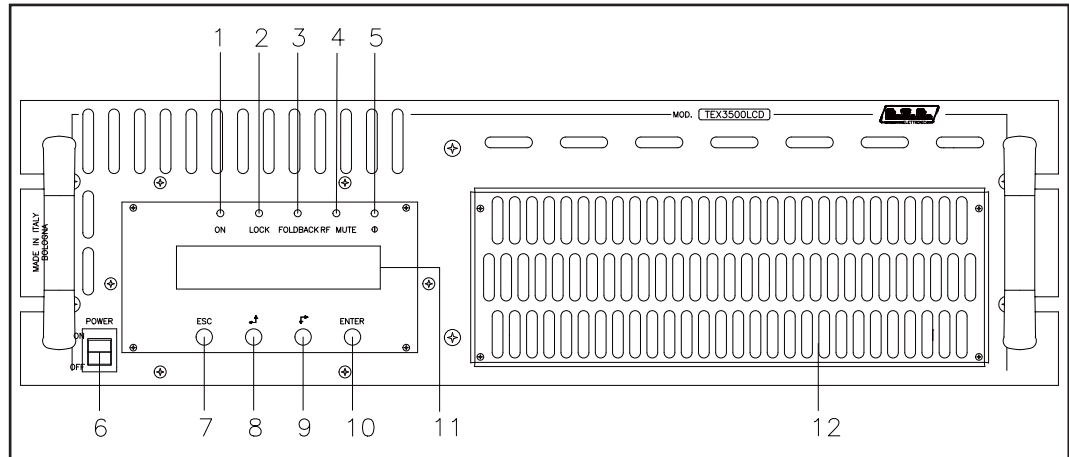



Figure 4.1

- |   |   |
|---|---|
| [1] ON  | Green LED - Turns on when transmitter is powered on.  |
| [2] LOCK  | Green LED verde - Turns on when PLL is locked to operating frequency.                         |
| [3] FOLDBACK  | Yellow LED - Turns on when foldback current limiting (Automatic Gain Control) kicks in.       |
| [4] R.F. MUTE   | Yellow LED - Turns on when exciter power output is inhibited by an external interlock signal. |
| [5] CONTRAST  | Display contrast trimmer.   |
| [6] POWER   | ON/OFF key.   |
| [7] ESC   | Press this button to exit a menu.   |
| [8]  | Navigation button used to browse menu system and edit parameters.                             |
| [9]  | Navigation button used to browse menu system and edit parameters.                             |
| [10] ENTER  | Push button to confirm a parameter and to enter in a menu.                                    |
| [11] DISPLAY  | Liquid crystals display.  |
| [12] AIR FLOW   | Air grille for the forced ventilation.  |

### 4.4 Rear Panel Description

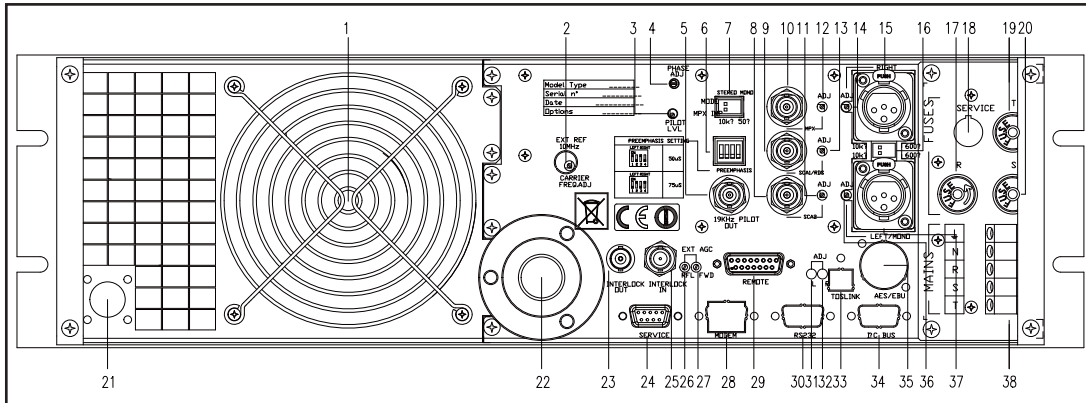

Figure 4.2

- |                      |   |
|----------------------|---|
| [1] AIR FLOW         | Air grille for the forced ventilation.  |
| [2] EXT REF 10MHz    | Reserved for future implementations.  |
| [3] PILOT ADJ        | Pilot tone trimmer.   |
| [4] PHASE ADJ        | Phase trimmer.  |
| [5] 19 kHz PILOT OUT | Tone output BNC connector, may be used to synchronise external devices such as RDS coders.  |
| [6] PREEMPHASIS      | Preemphasis dip-switch, provides two settings: 50 or 75 $\mu$ s. Preemphasis affects the right and left inputs in stereo mode and the mono input. MPX inputs are not affected by preemphasis setting. |
| [7] MODE/MPX IMP     | Dip-switch used to select transmission mode (STEREO or MONO) and MPX input impedance (50 $\Omega$ or 10 k $\Omega$ ).   |
| [8] SCA2             | BNC connector for SCA2 input.   |
| [9] SCA1/RDS         | BNC connector for SCA1/RDS input.   |
| [10] MPX             | Unbalanced MPX input BNC connector.   |
| [11] SCA2 ADJ        | Trimmer for SCA2 input level adjustment.  |
| [12] MPX ADJ         | Trimmer for MPX input level adjustment.   |
| [13] SCA1/RDS ADJ    | Trimmer for SCA1/RDS input level adjustment.  |
| [14] RIGHT ADJ       | Trimmer for right input level adjustment.   |
| [15] RIGHT           | Right audio channel input XLR connector.  |
| [16] IMPEDANCE       | Dip-switch used to select balanced audio input impedance (600 $\Omega$ or 10 k $\Omega$ ).  |
| [17] FUSE R          | Mains power supply fuse.  |
| [18] SERVICE         | Reserved for future implementations.  |
| [19] FUSE T          | Mains power supply fuse.  |
| [20] FUSE S          | Mains power supply fuse.  |
| [21] INPUT POWER     | Not used.   |
| [22] R.F. OUTPUT     | RF output connector, 7/8".  |
| [23] INTERLOCK OUT   | Interlock output BNC connector: when the transmitter goes into stand-by mode, the (normally floating) central conductor is switched to ground.  |
| [24] SERVICE         | DB9 connector for factory setting.  |
| [25] INTERLOCK IN    | Interlock input BNC connector: the exciter is forced in standby mode when the inner conductor is grounded.  |
| [26] FWD EXT. AGC    | Trimmer to set output power limitation according to FWD fold input.   |
| [27] RFL EXT. AGC    | Trimmer to set output power limitation according to RFL fold input.   |
| [28] MODEM           | Reserved for future implementations.  |
| [29] REMOTE          | DB15 telemetry connector.   |

[30] RS232	DB9 connector for direct serial communication or modem (only with telemetry option).
[31] LEFT ADJ	Reserved for future implementations - adjustment trimmer for Left digital channel input.
[32] RIGHT ADJ	Reserved for future implementations - adjustment trimmer for Right digital channel input.
[33] TOSLINK	Reserved for future implementations - TOS-LINK connector for digital audio input through fiber optic.
[34] I2C BUS	Normally not used, or used for customized functions (only with telemetry option).
[35] AES/EBU	Reserved for future implementations - XLR connector for AES/EBU digital audio input.
[36] LEFT/MONO ADJ	Trimmer di regolazione dei livelli dell'ingresso sinistro.
[37] LEFT/MONO	Connettore XLR per l'ingresso audio canale sinistro.
[38] MAINS	Connectors for 230 V (+/- 15%) 50-60 Hz mains power supply.

## 4.5 Connector Pinouts

### 4.5.1 RS232

Type: Female DB9



1	NC
2	TX_D
3	RX_D
4	NC
5	GND
6	NC
7	NC
8	NC
9	NC

### 4.5.2 Service (for programming of factory parameters)

Type: Female DB9

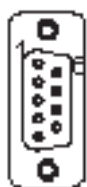

1	NC
2	TX_D
3	RX_D
4	Internally connected to 6
5	GND
6	Internally connected to 4
7	Internally connected to 8
8	Internally connected to 7
9	NC

### 4.5.3 Left (MONO) / Right

Type: Female XLR



1	GND
2	Positive
3	Negative

4.5.5 Remote

Type: Female DB15



Pin	Name	Type	Purpose
1	Interlock	IN	Inhibits power if closed to GND
2	Ext AGC FWD	IN	Ext. signal, 1-12V, for limitation (AGC)
3	GND		Ground
4	SDA IIC	I/O	Serial data for IIC communication
5	VPA TIm	ANL OUT	PA supply voltage: 3.9V F.S.
6	FWD TIm	ANL OUT	Forward power: 3.9V F.S.
7	Power Good	DIG OUT	Indicates activation by switching the normally-open contact to ground.
8	GND		Ground
9	GND		Ground
10	Ext AGC RFL	IN	Ext. signal, 1-12V, for limitation (AGC)
11	SCL IIC	I/O	Clock for IIC communication
12	IPA TIm	ANL OUT	PA supply current: 3.9V F.S.
13	RFL TIm	ANL OUT	Reflected power: 3.9V F.S.
14	On cmd	DIG IN	A pulse towards ground (500 ms) triggers power output
15	OFF cmd	DIG IN	A pulse towards ground (500 ms) inhibits power output



## 5. Quick guide for installation and use

This section provides a step-by-step description of equipment installation and configuration procedure. Follow these procedures closely upon first power-on and each time any change is made to general configuration, such as when a new transmission station is added or the equipment is replaced.

Once the desired configuration has been set up, no more settings are required for normal operation; at each power-up (even after an accidental shutdown), the equipment defaults to the parameters set during the initial configuration procedure.

The topics covered in this section are discussed at greater length in the next sections, with detailed descriptions of all hardware and firmware features and capabilities. Please see the relevant sections for additional details.

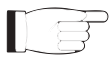

**IMPORTANT:** *When configuring and testing the transmitter in which the equipment is integrated, be sure to have the Final Test Table supplied with the equipment ready at hand throughout the whole procedure; the Final Test Table lists all operating parameters as set and tested at the factory.*

### 5.1 Preparation

#### 5.1.1 Preliminary checks

Unpack the transmitter and immediately inspect it for transport damage. Ensure that all connectors are in perfect condition.

The main fuse can be accessed from the outside on the rear panel. Extract the fuse carrier with a screwdriver to check its integrity or for replacement, if necessary.

The following fuses are used::

	<b>TEX3500LCD @ 230 Vac</b>
<b>MAINS FUSE</b>	<b>(2x) F 10A type 6x30</b>

Table 5.1: Fuse

The mains power supply unit is the full-range type and requires no voltage setup.

Provide for the following (applicable to operating tests and putting into service):

- √ Single-phase 230 (-15% / +10%) Vac mains power supply, with adequate earth connection.

- √ For operating tests only: dummy load with 50 Ohm impedance and adequate capacity (minimo 3500W per **TEX3500LCD**).
- √ Connection cable kit including:
  - Coaxial cable with BNC connectors for interlock signal connection.
  - RF cable for output to load / antenna (50 Ohm coaxial cable with standard 7/8" connector).
  - Audio cables between transmitter and audio sources.

## 5.1.2 Connections

Connect the RF output of the transmitter to the antenna cable or a dummy load capable of dissipating transmitter output power. To begin with, set transmitter to minimum output power and switch it off.

Connect the transmitter INTERLOCK IN input to the matching INTERLOCK OUT output fitted on R.V.R. Elettronica equipment to act as hybrid couplers. If your equipment is a different brand, identify an equivalent output.

Connect the RF output to an adequately rated dummy load or to the antenna.



**WARNING: Electric shock hazard! Never handle the RF output connector when the equipment is powered on and no load is connected. Injury or death may result.**

Ensure that the **POWER** switch on the front panel is set to “**OFF**”.

Connect the mains power cable to the MAINS connector on the rear panel.



**Note :** *The mains must be equipped with adequate ground connection properly connected to the machine. This is a pre-requisite for ensuring operator safety and correct operation.*

Connect the audio and RDS/SCA signals from user's sources to the transmitter input connectors.

## 5.2 First power-on and setup

Perform this procedure upon first power-up and each time you make changes to the configuration of the transmitter this component is integrated into.



**Note :** *Standard factory settings are RF output power on (**Pwr OFF**) and regulated output power set to lower limit (unless otherwise specified by customer).*

### 5.2.1 Power-on

When you have performed all of the connections described in the previous paragraph, power on the transmitter using the suitable power switch on the front panel.

### 5.2.2 Power check

Ensure that the **ON** LED turns on. Forward power and modulation readings should appear briefly on the display. If the RF output is disabled, those readings will be zero.

When the **PLL** locks to operating frequency, the LOCK LED will turn on.

### 5.2.3 How to enable the RF output

Check output power level and set it to maximum level (unless it has already been set) from the *Power Setup* menu that you will have accessed by pressing the following sequence of key: **ESC** (opens **Default Menu**) ⇒ **ENTER** (hold down for 2 seconds) ⇒ **SET** ⇒ use keys to set bar to upper limit.



Check the state of the **Pwr** output power by the **Fnc** menu. If it is set to **OFF**, press **ENTER** to bring the selection to **ON**.

### 5.2.4 Output power level control



**IMPORTANT:** *The transmitter incorporates Automatic Gain Control (AGC) and output power is modulated based on the power level set by the user and actual operating conditions, such as temperature, reflected power and other parameters. Please read section 5.3 for more details of RF power modulation.*

Access the **Power Setup Menu** pressing the following keys in the order: **ESC** (opens **Default Menu**) ⇒ **ENTER** (hold down for 2 seconds).

Use the keys  and  in the **SET** menu to set transmitter output power; the setting bar at the side of **SET** provides a graphic indication of power setting; please consider that the forward power readout provided on the display (**FWD: xxxx W**) reflects actual output power reading, **which may be lower than regulated power supply when Automatic Gain Control is running in power supply limitation mode** (please read section 5.3 about RF power supply modulation for more details).



**Note:** *Output power may be set using the **Pwr OFF** control. In this condition, the output power readout (**Fwd**) on the display will read 0 (zero); the **SET** bar will reflect any adjustments you make using the keys and provides a graphic indication of how much power supply will be delivered the moment you return to **Pwr On** state.*

### 5.2.5 Changing the *Power Good* alarm threshold

Change Forward Power Good alarm setting **PgD** from the **Fnc** menu as desired (factory setting is 50%).

### 5.2.6 Setting equipment I<sup>2</sup>C address

Change the **IIC** address in the **MIX** (Miscellaneous) menu as desired (factory setting is 01).

### 5.2.7 Adjustments and calibration

The only manual adjustments are the level adjustments and the audio mode adjustment.

The rear panel holds the trimmers for all transmitter inputs. Trimmer identification is printed on the rear panel. Input sensitivity can be set within the limits set out in the tables below through the trimmers:

Input sensitivity in Mono mode:

Input	Figure 6.2	Trimmer	Sensitivity	Note
SCA1/RDS	[9]	[13]	- 8 ÷ +13 dBm	Input level for 7,5 kHz deviation (-20 dB)
SCA2	[8]	[11]	- 8 ÷ +13 dBm	
MPX	[10]	[12]	-13 ÷ +13 dBm	Input level for 75 kHz deviation (0 dB)
Mono	[37]	[36]	-13 ÷ +13 dBm	

Input sensitivity in Stereo mode:

Input	Figure 6.2	Trimmer	Sensitivity	Note
SCA1/RDS	[9]	[13]	- 8 ÷ +13 dBm	Input level for 7,5 kHz deviation (-20 dB)
SCA2	[8]	[11]	- 8 ÷ +13 dBm	
MPX	[10]	[12]	-13 ÷ +13 dBm	Input level for 75 kHz deviation (0 dB)
Left	[37]	[36]	-13 ÷ +13 dBm	
Right	[15]	[32]	-13 ÷ +13 dBm	

When setting input sensitivity, please consider that the default menu reports instantaneous modulation level and an indicator provides a 75 kHz reading. To ensure correct adjustment, apply a signal with the same level as user’s audio broadcast maximum level and then adjust using the trimmer until instantaneous deviation matches the 75 kHz reading.

To set subcarrier input levels, you may use the same procedure and option “x10” available in the Fnc menu. With this option, modulation level is multiplied by a factor of 10, which means that default menu bar meter reflects a 7.5 kHz deviation.

A special menu with separate indications of Left and Right channel levels and relating indicators of nominal levels for maximum deviation (75 kHz) is provided.

- Preemphasis:



- L and R (XLR type) input impedance:



Switch 1: R XLR input impedance, ON = 600 Ω, OFF = 10 kΩ

Switch 2: L XLR input impedance, ON = 600 Ω, OFF = 10 kΩ

- MPX input operation mode/impedance:



Switch 1: Mode of operation ON = Mono, OFF = Stereo

Switch 2: MPX input impedance, ON = 50 Ω, OFF = 10 kΩ

### 5.3 Operation

- 1) Power on the transmitter and ensure that the **ON** light turns on. Equipment name should appear briefly on the display, quickly followed by modulation and forward power readings, provided that the transmitter is delivering output power.



*Menu 1*

- 1b) To **modify power level setting**, hold down the **ENTER** button until opening the **power setup menu**.

The edit screen will look like this:



*Menu 2*

Next to **SET** indication, a bar provides a graphic display of preset output power. The filled portion of the bar is proportional to set power level.

Example		
100% output power	Full bar	$\cong$ 110/120% of nominal power $\cong$ 3850/4200W in output (mod. TEX3500LCD)
50% output power	Half bar	$\cong$ 75% of nominal power $\cong$ 2625W in output (mod. TEX3500LCD)
25% output power	1/4 bar	$\cong$ 40% of nominal power $\cong$ 1400W in output (mod. TEX3500LCD)

The bottom line provides instantaneous power reading (in this example 3.4kW for **TEX3500LCD**, falling below 1.6kW the reading back to Watt. As result of hysteresis power up , exceeding 1400W the reading back to kWatt); press button to increase level, press to decrease it. When you have achieved the desired level, press **ENTER** to confirm and exit the **default menu**. Please note that the setting is stored automatically; in other words, if you press **ESC** or do not press any keys before the preset time times out, the latest power level set will be retained.



**NOTE:** This feature prevents the machine from delivering maximum power as soon as output is enabled from menu 4, or in the event the machine is already set to **ON** and energised.

- 2) Ensure that machine is not in a locked-out state. Press the **ESC** key to call up the selection screen (Menu 3). Highlight **Fnc** and press **ENTER** to confirm and access the appropriate menu (menu 4).

In the same menu, ensure that power limiting is disabled: if **PWR** is set to **OFF**, i.e. power output is disabled, move cursor to **PWR**. Press **ENTER** and label will switch to **ON**, i.e. power output enabled.

Press **ESC** twice to go back to the **default menu** (menu 1).

- 3) Fine tune power setting from menu 2 (see description of item 1b) until achieving the desired value.



**WARNING:** Machine is capable of delivering more than rated output power (3500 W); however, never exceed the specified power rating.

Next, you can review all operating parameters of the machine through the management firmware.

Normally, the machine can run unattended. Any alarm condition is handled automatically by the safety system or is signalled by the LED indicators on the panel or by display messages.





NOTE: Standard factory settings are: output power set to upper limit (unless otherwise specified by customer) and **OFF**.

### 5.4 Management Firmware

The machine features an LCD with two lines by 16 characters that displays a set of menus. Figure 5.2 below provides an overview of machine menus.

The symbols listed below appear in the left portion of the display as appropriate:

- ▬ (Cursor) - Highlights selected (i.e. accessible) menu.
- ▶ (Filled arrow) - Editable parameter marker. This symbol appears in menus that take up more than two lines to aid browsing.
- ▶▶▶ (Three empty arrows) - Parameter is being edited.
- ▶ (Empty arrow) - Current line marker; the parameter in this line cannot be edited. This symbol appears in menus that take up more than two lines to aid browsing.

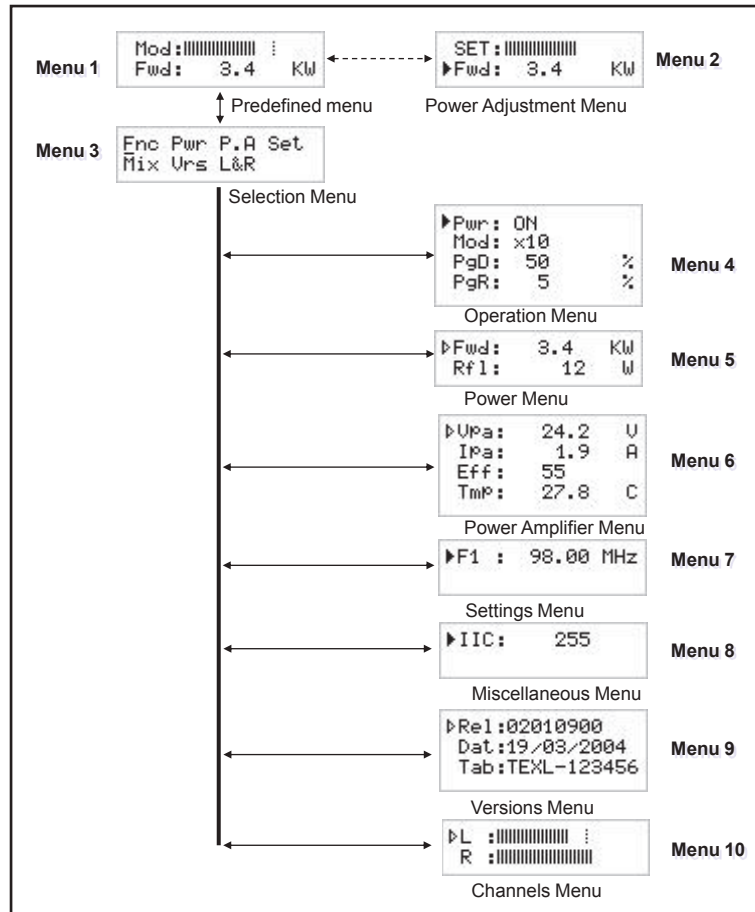

Figure 5.2

When the display is off, touching any key will turn on backlighting.

When the display is on, pressing the **ESC** button from the **default menu** (menu 1) calls up the **selection screen** (menu 3), which gives access to all other menus:

```

Fnc Pwr P.A Set
Mix Urs L&R
    
```

Menu 3

If the temperature alarm is enabled and the alarm threshold is exceeded, the following screen will be displayed (only if you are in the default screen):

```

!! ATTENTION !!
OVER TEMPERATURE
    
```

State 1

As soon as operating conditions are restored, power output is re-enabled with the same settings in use prior to the alarm condition.

Under 20kHz, no modulation occurs. After a preset time of about 5 minutes (not editable), a NO AUDIO condition is indicated in the main screen, but power is not inhibited.

```

Mod: NO AUDIO
Fwd:      0      W
    
```



State 2

To gain access to a submenu, select menu name (name is highlighted by cursor) using button   or   and press the **ENTER** button.

To return to the **default menu** (menu 1), simply press **ESC** again.

### 5.4.1 Operation Menu (Fnc)

In this menu, you can toggle transmitter **power output** On/Off, set **deviation display mode** and the threshold rate for **Forward (PgD)** or **Reflected (PgR)** Power Good.

To edit an item, highlight the appropriate line using the  and  buttons and then press and hold the **ENTER** button until the command is accepted. This way, Pwr setting is toggled between On and Off and Mod setting is toggled between “x1” and “x10”. To edit the Power Good rate, simply select item “PgD” or “PgR” and edit its value using the UP and DOWN buttons; finally, press **ENTER** to confirm.

```

▶ Pwr : ON
  Mod : x10
  PgD : 50      %
  PgR : 5       %
    
```

*Menu 4*

- Pwr Enables (ON) or disables (OFF) transmitter power output.
- Mod Modifies modulation display (toggles between “x1” and “x10”). In “x10” mode, instantaneous deviation indication is multiplied by a factor of 10, and the bar meter on the default menu will reflect 7.5 kHz instead of 75 kHz. This display mode is convenient when you wish to display low deviation levels, such as those caused by pilot tone or subcarriers.
- PgD Modifies Power Good threshold for forward power. The Power Good rate is a percent of equipment rated power (3500W for **TEX3500LCD**), not of forward output power. This means that this threshold set at 50% will give 1750 W, respectively, regardless of set power level. The Power Good feature enables output power control and reporting. When output power drops below set Power Good threshold, the equipment changes the state of pin [7] of the DB15 “Remote” connector located on the rear panel.
- PgR Modifies Power Good threshold for reflected power. The Power Good rate is a percent of equipment rated power (350W for **TEX3500LCD**), not of reflected output power. This means that this threshold set at 4%, respectively, will give 14W regardless of set power level. The Power Good feature enables output power control and alarm management.



**NOTE:** This alarm does not trip any contacts in the DB15 “Remote” connector and is only available in systems equipped with telemetry.

### 5.4.2 Power Menu (Pwr)

This screen holds all readings related to equipment output power:



P Fwd:	3.4	KW
Rfl:	12	W

Menu 5

- Fwd Forward power reading.
- Rfl Reflected power reading.

Note that these are readings, rather than settings, and cannot be edited (note the empty triangle). To change power setting, go to the **default menu** as outlined earlier.

### 5.4.3 Power Amplifier (P.A) Menu

This screen is made up of four lines that can be scrolled using the  and  buttons and shows the readings relating to final power stage:

P Vpa:	50.2	V
I Pa:	32.9	A
Eff:	57	%
Tmp:	27.8	°C

Menu 6

Note that these are readings, rather than settings, and cannot be edited (note the empty arrow).

- VPA Voltage supplied by amplifier module.
- IPA Current draw of amplifier module.
- Eff Efficiency based on ratio of forward power to amplifier module power, in percent ( FWD PWR/(Vpa x Ipa) % ).
- Tmp Equipment internal temperature reading.

### 5.4.4 Setup Menu (Set)

This menu lets you view and set operating frequency.

```
▶F1 : 98.00 MHz
```

Menu 7

F1 Operating frequency setup. Set a new frequency value and then press the **ENTER** button to confirm your selection; the transmitter unlocks from current frequency (the **LOCK** LED turns off) and will lock to the new operating frequency (**LOCK** turns back on again). If you press **ESC** or let the preset time time out, the previous frequency setting is retained.

#### 5.4.5 Miscellaneous Menu (Mix)

This menu lets you set equipment address in an I<sup>2</sup>C bus serial connection:

```
▶IIC: 255
```

Menu 8

IIC I<sup>2</sup>C address setting. The I<sup>2</sup>C network address becomes significant when the transmitter is connected in an RVR transmission system that uses this protocol. Do not change it unless strictly required.

#### 5.4.6 Version Menu (Vrs)

This screen holds equipment version/release information:

```
▶Rel:02010900
Dat:19/03/2004
Tab:TEXL-123456
```

Menu 9

Note that these are readings, rather than settings, and cannot be edited (note the empty arrow).

Rel	Firmware release information.
Dat	Release date.
Tab	Shows table loaded in the memory.

### 5.4.7 Channels Menu (L&R)

Right and left channel input levels are displayed as horizontal bars as shown in the figure below.

The bar meter reflects the level corresponding to a 100% deviation for each channel and provides a convenient reference when setting audio channel input levels.

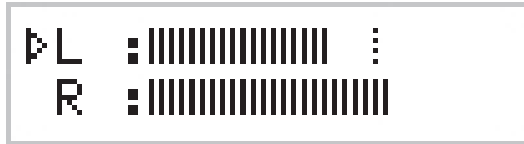

Menù 10

- L Left channel Vmeter.
- R Right channel Vmeter..

## 5.5 Optional functions

A range of options is available for the product to add certain functions and/or modify existing functions. Outlined below are the functions available at the moment, which must be specified on order.

### 5.5.1 FSK option

The FSK function generates periodic carrier frequency shifts to generate a Morse-coded station ID code.



**NOTE: This function is typically used in the USA.**

The factory setting for frequency shift amplitude is +10KHz and code repetition period is 60 minutes (please contact R.V.R. Elettronica if you need different settings), whereas station identified may be programmed by the user following the indications provided in next section.

When the FSK option is fitted, an FSK submenu is added to the **selection menu**.

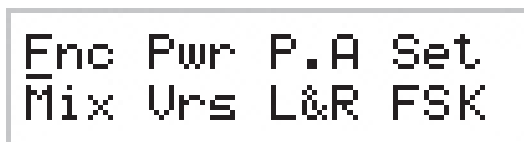

Menu 11

Press the **ENTER** key when FSK is highlighted in the **selection menu** to access the FSK submenu:



```

▶ FSK:      ON
Cod: 012345
    
```

*Menu 12*

FSK                      Enables / disables FSK code transmission.

Cod                      Shows the Morse code sent normally..

### 5.5.1.1 Changing the ID code

User may change the FSK code used as a station identifier at any time.

This procedure requires:

- 1 RS232 male-female cable;
- Hyper Terminal interface (make sure it has been installed together with Windows®) or equivalent serial communication software

A brief description of the procedure is provided below:

- Connect the PC serial port COM to the SERVICE connector on the rear panel of **TEX3500LCD** using a standard Male DB9 - Female DB9 serial cable.
- Power on the transmitter;
- Launch the serial communication software;
- Set communication parameters as follows:

**Baud Rate:** 19200

**Data Bit:** 8

**Parity:** None

**Stop Bit:** 1

**Flow control:** None;

- Activate Caps-Lock through the communication software and send string CODE followed by the 6-character station ID code followed by Enter.



**NOTE:** To be treated as valid, the code must be made up of 6 alphanumeric characters and must contain no blank spaces; if acknowledged as valid, code is echoed back to the terminal, illegal codes are not echoed.

### 5.5.2 Power UP/DOWN Option

The Power UP/DOWN option modifies the signal receive function for the signals present at the telemetry connector.

RF section on / off control signals are treated as control signals for RF output power level to allow for UP/DOWN setting.

The UP or DOWN command is provided by switching the corresponding signal at the connector to ground for at least 500mS (pin features internal pull-up to power supply).

Configuration of DB15F telemetry connector (Remote):



Pin	Standard function	Power UP/DOWN function
14	On cmd Enables RF output power	Up cmd Increases RF output power
15	Off cmd Disables RF output power	Down cmd Decreases RF output power

### 5.5.3 RDS Option

Built-in RDS system with standard basic functions.



**NOTE:** For further informations, read WINRDS manual

### 5.5.4 Internet Telemetry Option

Telemetry system via the Internet.



**NOTE:** For further informations, read /TLW manual

### 5.5.5 Basic Internet Telemetry Option

Basic telemetry system via the Internet.



**NOTE:** For further informations, read /TLW-E manual

### 5.5.6 Telemetry Option with built-in modem

Telemetry system via internal GSM modem. Battery and battery changer included.



**NOTE:** For further informations, read /TLM manual

### 5.5.7 Telemetry Option without built-in modem

Internal telemetry system without modem.



**NOTE:** For further informations, read /TLC manual.

## 6. Identification and Access to the Modules

The **TEX3500LCD** is made up of various modules linked to each other through connectors so as to make maintenance and any required module replacement easier.

### 6.1 Upper view (TEX3500LCD)

The figure below shows the equipment upper view with the various components pointed out.

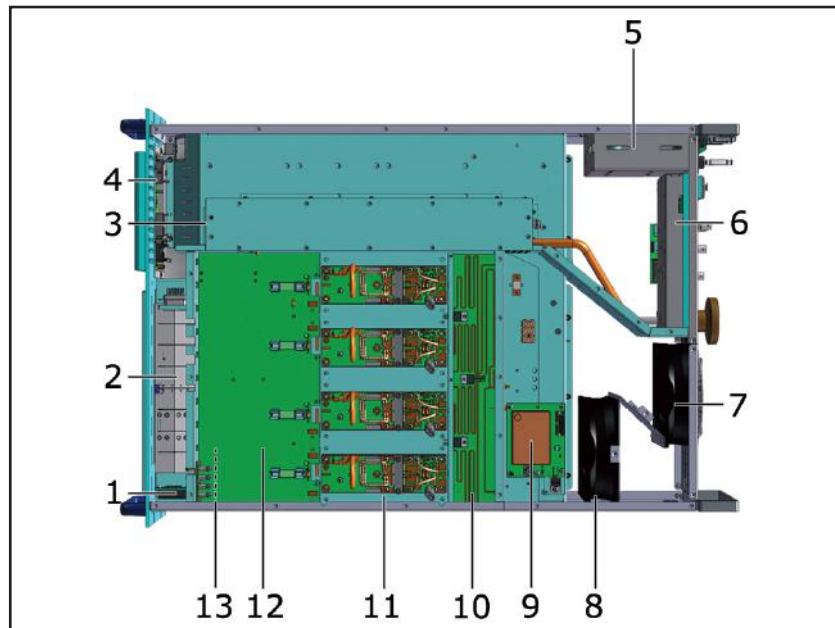

Figure 6.1

- [1] DB15 flat filter card
- [2] Bias card
- [3] LPF card
- [4] Panel card
- [5] Surge protection card
- [6] Main board
- [7] FAN1
- [8] FAN2
- [9] Driver card & Temperature Measure Board
- [10] Splitter card
- [11] RF modules
- [12] Fuse card
- [13] Combiner card

## 6.2 Bottom view (TEX3500LCD)

Figure 6.2 below shows a bottom view of the equipment and component locations.

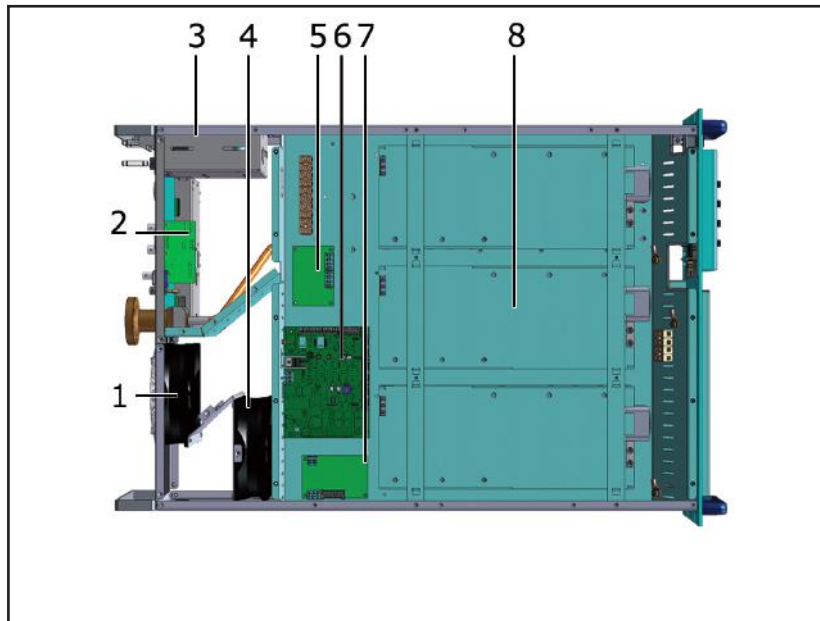

Figure 6.2

- [1] FAN1
- [2] Telemetry card
- [3] Voltage services generator card
- [4] FAN2
- [5] PS interface card
- [6] Interface card and fan control
- [7] Power adapter interface card
- [8] Power supplies modules

## 7. Working Principles

The figures below provide an overview of **TEX3500LCD** (fig. 7.1) modules and connections.

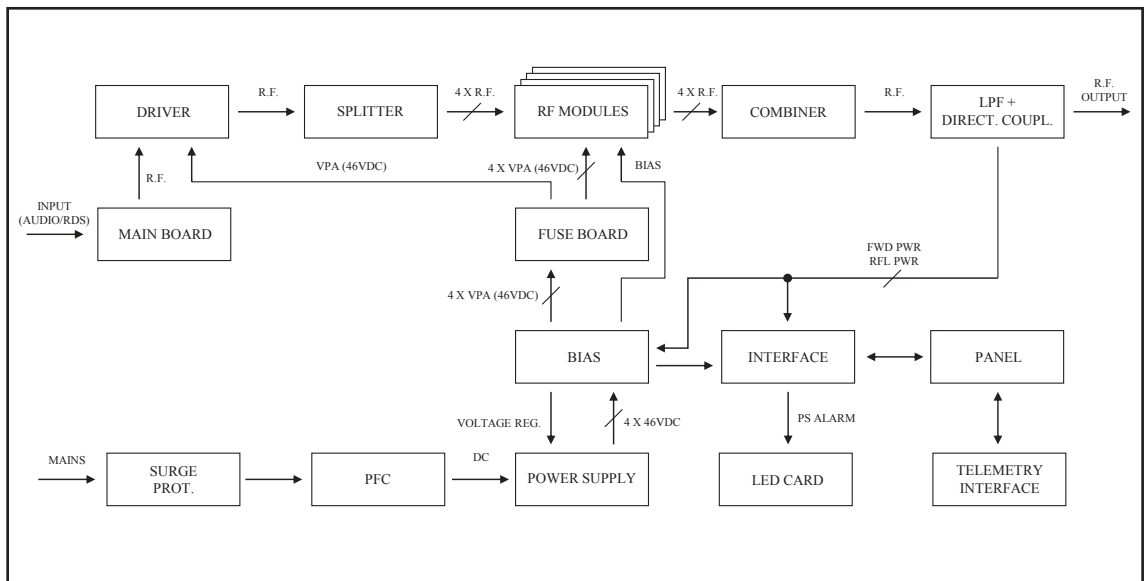

Figure 7.1

Following is a brief description of the different module functions; all diagrams and board layout diagrams are included in the “Technical Schedule” Vol.2.

### 7.1 Power supply

The **TEX3500LCD** power supply can be divided into two basic sections: Services and Power Supply, which provide adequate power to the RF power amplifier modules.

The unit has a rectifier (PFC) able to ensure a  $\cos \phi$  of 0.998 and a switching power supplies that allow an efficiency of 90%.

### 7.2 Interface board

This board performs the following tasks:

- It uses AC voltage to generate and distribute service power supply over the panel card;
- It controls and provides interfacing of the power amplifier supply module;
- It processes and provides interfacing of the control signals to/from the Bias card;
- It processes and provides interfacing of the control signals to/from the Panel card.
- It feeds and operates the cooling fans.

### **7.3 Panel card**

The panel board accommodates the microcontroller that runs equipment firmware and all user interface elements (display, LEDs, keys, ...).

This board is interfaced with other equipment modules via flat cables and provides for power supply, control signals and measurement distribution.

### **7.4 Main Board**

The main board performs the following tasks:

- Audio and SCA input treatment;
- Generation of carrier frequency;
- Modulation ;
- R.F. amplification (Driver).

The board also features a stereophonic coder.

#### **7.4.1 Audio input section**

The audio input section accommodates the circuitry that performs the following tasks:

- Input impedance selection
- 15 kHz filtering for R and L channels
- Stereophonic coding
- Preemphasis
- Mono, MPX and SCA channel mixing
- Clipper (limits modulating signal level so that frequency deviation never exceeds 75kHz)
- Modulating signal measurement.

#### **7.4.2 PLL/VCO section**

This section of the board generates the modulated radiofrequency signal. It is based on a PLL architecture that includes an MB15E06 integrated circuit.

### **7.5 Driver Board**

This section accommodates a BFG35 and a MRFE6S9060 transistor that preamplifies the RF signal before it is relayed to the final power amplifier. When



the exciter is placed into stand-by mode, the driver is inhibited, too.

By entering with 5dBm it is able to deliver up to 32 W for **TEX3500LCD**.

## 7.6 Power amplifier

The RF power amplification section consists in several power modules (four on the **TEX3500LCD**) coupled through a Wilkinson splitter and combiner using strip-line technology.

Each RF module of the **TEX3500LCD** provides 900 W rated power using a single active element built using LD-MOS technology. RF modules are fed by the switching power supply via the Bias board.

The splitter splits the incoming power input signal equally to all RF modules. The combiner combines the power output signals available at module outputs to obtain total amplifier power.

Splitter, amplifiers and combiner have been designed to sum amplifier output power signals in phase, so as to keep unbalance and power dissipation to a minimum.

The whole RF section is mounted on a finned heat sink with fan cooling.

## 7.7 LPF Board

This board incorporates a low-pass filter to keep amplifier harmonics within permissible limits as specified by international standards.

A directional coupler is provided at filter output to measure forward and reflected RF output power; power readings are relayed to the Interface and Bias boards to enable processing and display.

The LPF board incorporates an RF output (having a level about -60 dB lower than output level) which is brought to a BNC connector. This provides a convenient test point to check carrier characteristics, but **does not ensure accurate assessment of higher harmonics**.

The filter also has a High Pass Filter section that sends the third harmonic generated by the final stage to a termination 50 Ohm 250 W (mounted near the driver); this stratagem helps to maintain a sufficiently high efficiency even in case of presence of SWR in antenna.

## 7.8 BIAS board

The main purpose of this board is to control and correct the bias voltage of the RF amplification section MOSFETs.

It also provides a measure of the total current drawn by the RF modules and incorporates a dedicated circuit for power supply fault reporting. Under normal conditions, bias voltage is adjusted according to set output power using feedback based on actual output power reading (AGC). Abnormal conditions affecting bias voltage so as to trigger foldback current limiting are:

- Reflected output power too high
- External AGC signals (Ext. AGC FWD, Ext. AGC RFL)
- Temperature too high
- Current draw of one RF module too high

## 7.9 External Telemetry Interface Board

This board provides an I/O interface for the CPU with the outside environment. All available equipment input and output signals are brought to the REMOTE DB15 connector.

Also mounted on this board is the INTERLOCK IN BNC connector which can disable device power output. When the central pin is closed to ground, output power is limited to zero until ground connection is removed.





**R.V.R. Elettronica S.p.A.**

Via del Fonditore, 2 / 2c  
Zona Industriale Roveri · 40138 Bologna · Italy  
Phone: +39 051 6010506 · Fax: +39 051 6011104  
e-mail: [info@rvr.it](mailto:info@rvr.it) · web: <http://www.rvr.it>

ISO 9001:2000 certified since 2000



The RVR Logo, and others referenced RVR products and services are trademarks of RVR Elettronica S.p.A. in Italy, other countries or both. RVR ® 1998 all rights reserved.  
All other trademarks, trade names or logos used are property of their respective owners.